

OPERATING AND MAINTENANCE MANUAL

for

RADIO FREQUENCY MILLIWATTMETER

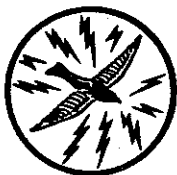

BIRD ELECTRONIC CORP.
CLEVELAND, OHIO

© Copyright 1969 Bird Electronic Corp.
Litro in U.S.A.



Fig. 1-1

**Model 6254 RF Wattmeter
SUMMARY OF BASIC SPECIFICATIONS**

Type:	TERMA LINE RF Wattmeter Model 6254
Input Impedance:	50 ohms
Termination VSWR:	1.15 max. dc-500 MHz
Type of Modulation:	CW or AM type signals, not designed for use on pulsed power.
Frequency Range:	30 to 500 MHz
Power Ranges:	Up to two watts full scale
Accuracy:	±5% of full scale
Connectors:	BNC (female) input jack
Weight:	2.2 pounds (equipment only)
Dimensions-Overall:	5-7/8 H x 4-3/8 W x 3-5/8 D

OPERATING AND MAINTENANCE MANUAL
for
TERMALINE®
RADIO FREQUENCY MILLIWATTMETER MODEL 6254

LIST OF ILLUSTRATIONS

	Page
Section 1 — General	1
Section 2 — Theory	2
Section 3 — Installation and Operation	3
Section 4 — Maintenance	4
Section 5 — Parts List	8

TABLE OF CONTENTS

	Page
Fig. 1-1 Model 6254 RF Wattmeter	a
Fig. 2-1 Circuit diagram — E^2/R method of power measurements	2
Fig. 2-2 Square law scale, watts vs. volts	2
Fig. 2-3 Schematic circuit diagram, Model 6254	2
Fig. 3-1 Outline drawing, Model 6254 Wattmeter	3
Fig. 4-1 Parts identification photograph	4
Fig. 4-2 Voltmeter Block E-601 and Cover E-602	5
Fig. 4-3 Connector Plug P-602	6
Fig. 4-4 Service for Connector Plug	6

SECTION 1 – GENERAL

1. SCOPE OF MANUAL

This instruction book covers the description, theory, operation and maintenance of the Model 6254 RF Wattmeter (Milliwattmeter), Fig. 1-1.

2. PURPOSE AND APPLICATION

The Model 6254 is designed to measure the power output, and facilitate the tuning of transmitters of low power output (up to **two watts**) The basic specifications are listed on the summary sheet at the front of this manual. It may be used as a dummy load of 50 ohms characteristic impedance for radio frequency power as above.

3. DESCRIPTION

The essentials of the Model 6254 Radio Frequency Wattmeter equipment are relatively simple. It consists of two primary elements as follows: RF load resistor and detector unit; and a direct-reading microammeter (in watts).

The energy of the transmitter is fed thru RF cable into the Load Resistor E-601 (thru BNC Jack J-601).

The load-resistor unit is mounted inside the lower left-hand side wall of the Wattmeter Housing A-601. Its output is thru dc Jack J-602 on the top of the load resistor block, and is fed thru Cable W-602 directly into the Microammeter M-601. The microammeter, of a sealed type and for which the detector units are specifically calibrated, is scaled to read dc current directly in RF milliwatts. The Housing A-601 (and hinged dial flap) furnish additional physical protection for the microammeter.

The back of the Housing A-601 has an access cover permanently hinged to the bottom edge of the box. This cover is fastened by a beryllium copper spring clasp at the top. Open the cover by pulling out firmly at the finger groove on the top of the housing. Across the top of the housing is a Strap O-601 for carrying convenience.

SECTION 2 – THEORY

1. GENERAL

A traditional method of measuring transmitter power at low frequencies utilizes the basic relationship $W = E^2/R$, illustrated in circuit diagram, Fig. 2-1. E is the voltage drop across a power dissipating resistor R. Accuracy in this method requires that the voltmeter be connected directly across the resistor terminals as well as the obvious necessity that both the voltmeter and resistor be accurate and corrected for operating frequency.

The resistor and terminals in the Model 6254 are designed to have a constant characteristic impedance of 50 ohms over a wide frequency range.

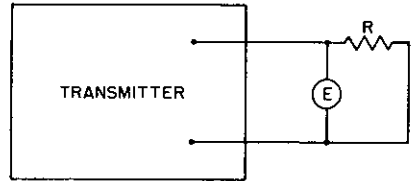

Fig. 2-1
Circuit Diagram E^2/R Method
of Power Measurements

2. VOLT vs. WATTS

The voltmeter of circuit in Fig. 2-1 may be equipped with a direct-reading scale in watts, for use with a definite load resistance R. This scale would be linear in watts if the voltmeter were of the square law type similar to thermocouple or iron vane meters.

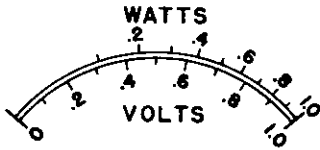

Fig. 2-2
Square Law Scale, Watts vs. Volts

When the voltmeter is a linear type, the watt scale will be as shown in Fig. 2-2. This compares equivalent voltage and power scales for a hypothetical 50.0 ohm, 1 watt, 1 volt instrument. Half full-scale deflection is obtained at one-fourth full scale power. The voltmeter used in the Model 6254 is approximately linear and the scale is of the type shown in Fig. 2-2.

3. VOLTMETER CIRCUIT, Fig. 2-3

The adjustable tap on R_1 (load resistor) serves as a voltage divider across the input voltage of resistor R_1 . The sample RF voltage so produced is fed to the germanium diode rectifier CR_1 . Functioning as a half-wave rectifier, CR_1 charges capacitor

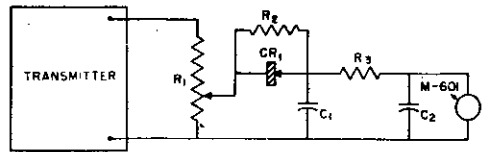

Fig. 2-3
Schematic Circuit Diagram Model 6254

C₁ to the peak RF voltage impressed on it by the R₁ voltage tap. The capacitance of C₁ is sufficiently low to maintain the proper time constant for the 30-500 MHz frequency range of this equipment. Resistor R₃ and microammeter M-601 form a dc voltmeter circuit used to measure the dc voltage developed across charge capacitor C₁. The capacitor C₂ is of relatively large value with a minimum of residual inductance. C₂ is an RF bypass for the microammeter, protecting against the effect of any stray RF currents. The entire circuitry is carefully shielded for protection against induced currents caused by external RF fields.

SECTION 3 -- INSTALLATION & OPERATION

1. INSTALLATION

The RF Wattmeter Model 6254 is a portable instrument with no provision for fixed mounting, and may be used in any desired location. The housing should be used in upright position wherever possible. See Fig. 3-1 for dimensional outline of wattmeter.

2. OPERATION

No switching, calibrating or tuning of the Model 6254 Wattmeter is required. Before applying power, check zero position of meter pointer. If required, adjust pointer by inserting small screwdriver in hole underneath meter flap and slightly twisting screw to move the pointer to zero position. Now turn on transmitter power and pull down meter flap on slant face. Read RF output directly in milliwatts. The accuracy of the instrument $\pm 5\%$ applies over the specified frequency range. For interpretation of greater accuracy the typical instrument measurements deviate slightly as follows: Approximately 3% low at 30 MHz, even calibration at 250 MHz, and approximately 5% high at 500 MHz.

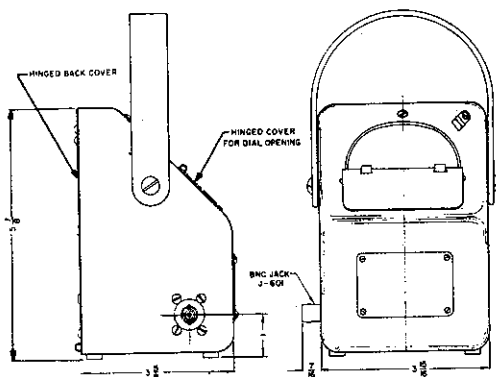

Fig. 3-1
Outline Drawing, Model 6254 Wattmeter

CAUTION

When the meter M-601 is attached to the load resistor, take care not to subject the unit to more than twice the full-scale power as indicated by the meter, i.e., for a 250 mW scale, not more than 500 mW, as injury to the meter may result. Also, be careful not to subject the load resistor to RF power in excess of 2.0 watts for an extended period, as damage to the crystal may result.

SECTION 4 – MAINTENANCE

1. GENERAL INSTRUCTIONS

The simplicity of this equipment makes its care and treatment relatively limited. **DO NOT DROP THE WATTMETER.** A bad drop or hard blow might upset the delicate mechanism of the microammeter or disturb the calibration of the pick-up and detector circuit. The equipment should generally be kept clean, and the dc connections tight. The clamping nuts on the two dc plugs P-602 on cable W-602 should be checked from time to time, making sure that the connections are sound. To improve the contact, swing the body of the plug back and forth a few times before retightening the nut.

The connectors, particularly the BNC plugs and jacks, should be kept covered as much as practicable. Do not leave these connectors around in dusty or dirty places. If the insides of the connectors become dirty, clean carefully with Inhibisol¹ or its equivalent, or trichlorethylene on a cotton swab stick. Clean all contact faces and exposed areas. Ventilate working area. For protection of the equipment, the back cover of the housing and meter dial flap should be kept closed at all times. The symbol identification and location of all replaceable parts are illustrated in Fig. 4-1.

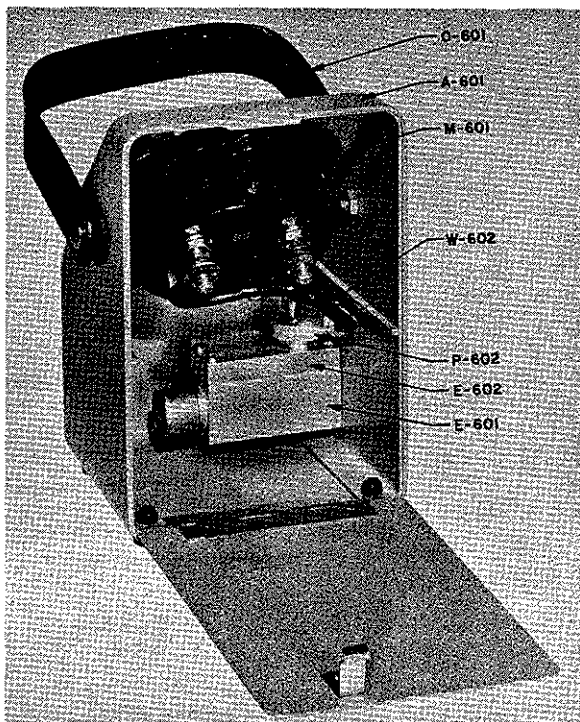

Fig. 4-1
Parts Identification Photograph

¹INHIBISOL is a registered trade name of a carbon tet replacement manufactured by the Penetone Co., Tenafly, N.J.

2. CRYSTAL DIODE AND LOAD RESISTOR

If the meter readings become irregular or questionable, the crystal may be faulty. Due to the sensitivity of this wattmeter and its critical calibration techniques, the units are now shipped with the resistor voltmeter units (Load Resistor, E-601) gilyptal sealed. Operators should not attempt to change crystals or recalibrate. If a crystal or load resistor is suspected of being defective the entire load resistor E-601 will have to be replaced. If doubt exists as to a unit being defective, contact the Bird Electronic Product Support Group for instructions.

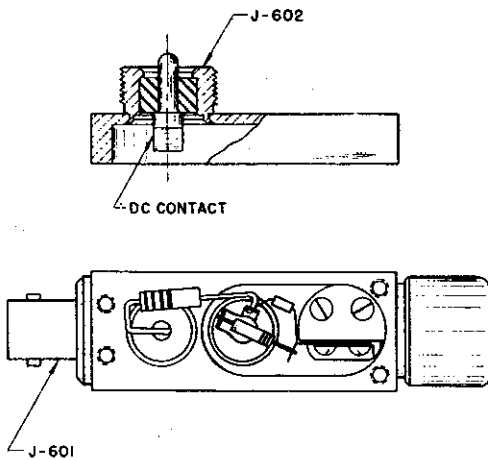

Fig. 4-2
Voltmeter Block E-601 And Cover E-602

3. DC CIRCUIT CABLE

If erratic or no readings are obtained, the dc cables and connectors should be removed and checked. Use a megger and ohmmeter to test dc cable W-602 for shorts or discontinuity. If the cable needs replacement, or connectors have to be refitted, proceed as follows:

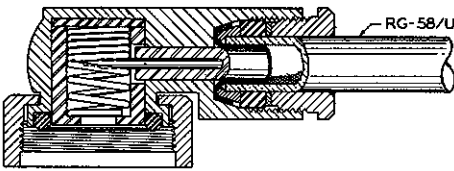

Fig. 4-3
Connector Plug P-602

Fig. 4-3 shows construction of the dc plugs P-602. Fig. 4-4 shows proper service of RG-58/U cable for these plugs. To remove cable from this plug unscrew the bushing and pull cable out. The center conductor of the cable makes tight contact between turns of the coil spring when assembled.

Assembly of the RG-58/U cable to dc plug P-602 is as follows:

- (1) Slip the bushing, washer, and grommet over end of cable
- (2) Remove outer insulation $\frac{9}{16}$ inch from end.
- (3) Slip collar over shielding (unbraided).
- (4) Fold back braids and trim as illustrated, Fig. 4-4.
- (5) Remove inside insulation to dimension shown.
- (6) Flatten end of center conductor to sharp chisel edge, push into dc plug P-602, aligning edge with turns of coil spring.
- (7) Push in grommet and washer and screw bushing down snugly.

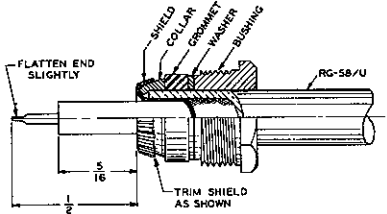

Fig. 4-4
Service for Connector Plug

If cables check good and an open circuit is still suspected, the spring contact on the base of dc connector or resistor housing cover E-602 should be checked for contact or pickup button, see Fig. 4-2.

4. CABLE AND WATTMETER CHECK

Assuming a good load resistor, and dc connections all checked OK, then the RF power cable should also be checked for continuity; and perhaps verified by test against a substitute cable having UG-88/U plugs. The simplest test in the event of uncertainty of the condition of a wattmeter is to compare the equipment against the results obtained on another Model 6254 RF Wattmeter.

5. MICROAMMETER MAINTENANCE

If no readings are obtained, it is likely that the meter M-601 is burned out, and consequently must be replaced. It may be tested by the following procedure:



CAUTION

DC Meter Tests — Testing of the meter should be attempted only by one familiar with circuitry and instruments for testing sensitive dc microammeters because of the danger of damaging it in unsuitable circuits. Test the meter as a microammeter in series with a low voltage battery, variable resistor and an external dc microammeter with an accuracy of $\pm 1\%$. Full scale current should be 30 microamperes $\pm 2\%$.

M-601 is a sensitive microammeter. Do not attempt to check it with an ohmmeter. Do not tamper with fastening nuts on back of case or attempt to repair its internal mechanism.

If the meter pointer becomes unseated, it may be possible to restore it by carefully tapping or jiggling to get the pointer pivot back in its socket. If this is impossible, the meter will have to be replaced. Please note that M-601 meters are so scaled that they may be used in the Model 6254 with any good load resistor E-601, but that a crystal may be used only with assigned load unit. Meters are easy to change by removing dc plug connection and unscrewing the three #6-32 flat head screw and nut assemblies from the front face of the meter housing.

6. Table 4-1. TROUBLE SHOOTING CHART

Defect	Possible Causes	Remedy
<p>A. No indication</p>	<ol style="list-style-type: none"> 1. No radio frequency power 2. Burned out crystal diode rectifier 3. Faulty dc cable 4. Meter M-601 damaged or burned out 5. No contact, or fault in dc jack J-602 on cover E-602 6. Load resistor E-601 burned out or faulty 	<ol style="list-style-type: none"> 1. Check transmitter, switch on, refer to operating instructions for equipment used 2. Factory Replacement 3a. Check contacts of dc connectors P-602. Sec. 4, Par. 3 b. Check dc cable W-602 and connectors for continuity or short circuit. Sec. 4, Par. 3 4. Replace meter. Sec. 4, Par. 5 5. Check and repair or replace 6. Factory Replacement
<p>B. Intermittent or inconsistent meter readings</p>	<ol style="list-style-type: none"> 1. Faulty RF cable 2. Sticky or defective Meter M-601 3. Faulty crystal diode 4. Faulty load resistor unit E-601 5. High VSWR on load 	<ol style="list-style-type: none"> 1. Check RF cable with or by comparison with another cable into Model 6254 Wattmeter. Sec. 4, Par. 4 2. Test meter and replace if defective. Sec. 4, Par. 5 3. Factory Replacement 4. Factory Replacement 5. Test load resistor E-601 with slotted line or with THRULINE® Wattmeter

SECTION 5 — PARTS LIST

Symbol	Part Name and Description	Function	Drawing Number
A-601	Housing Assembly: Aluminum die casting 5-7/8 x 4 x 3-5/8 rectangular case w/hinged covers, slanted meter face. Light Navy grey baked enamel. (MIL-E-15090)	Case for equipment	6254-011
E-601	Load Resistor (RF Section): Brass block 1-9/16 x 3/4 x 3-3/32 w/BNC connector & dc jack Bright Silver plated.	RF coaxial load resistor and rectifier circuit	6254-002-7
E-602	Cover, Resistor Housing: Brass block 11/16 x 3/4 x 2 w/dc jack. Bright Silver plated.	p/o E-601	6250-019
M-601	Meter, Microammeter: Bakelite case 2-3/4 Dia. and 3-1/2 Dia. x 1-5/8, 30 microamps. ±2% f.s., zero adjust.	Meter reads in RF power, up to two watts full scale, or as ordered	208004
O-601	Strap, Carry: Leather 11 x 7/8 x 5/32 Smooth black finish.	Carries wattmeter	8240-104
P-602	Connector, Plug dc: Brass 1-1/4 x 5/8 x 3/4 captive nut, Navy Type DS-491859. Bright Nickel Plated.	p/o W-602 Plugs for dc Cable	7500-076
W-602	Cable Assembly, dc: Vinyl cord, RG-58/U 5' lg w/one dc connector.	DC meter cord	4220-097-3