

INSTRUCTION BOOK
FOR
GATES' MODEL BC-250GY-1 TRANSMITTER

I.B. #888 0836 001

Gates Radio Company
Quincy, Illinois

MODULATION TRANSFORMER INSTRUCTIONS

Please read these instructions before attempting to test the modulation transformer in this transmitter.

The modulation transformer employed in this transmitter may be of a type which will indicate unequal resistance in the primary windings. An ohmmeter check of the windings may indicate that the transformer is defective; whereas in reality, this is a normal reading and the modulation transformer is performing normally.

In order to properly check this transformer outside of the transmitter circuit, merely apply 117 volts, 60 cycle a.c. to the secondary winding. Check the voltage on each half of the primary winding. If the transformer is operating normally, then these voltages should be approximately equal.

Gates Radio Company
Quincy, Illinois

INDEX

	Page
SECTION I - INTRODUCTION	1
SECTION II - BC-250GY-1 TRANSMITTER DETAILS	2
Oscillator Unit	2
Intermediate Amplifier	3
Power Amplifier	3
Audio Chassis	4
Relays	4
8008 Rectifier Tubes	5
Transformers	6
Wiring Detail	6
Connecting the Load	7
SECTION III - INITIAL TUNE-UP	8
General Operational Procedure	8
Tuning Procedure	10
Making Performance Measurements	13
SECTION IV - TYPICAL VOLTAGE AND CURRENT CONDITIONS OF BC-250GY-1 ...	16
Conclusion	16
Warranty	17
PARTS LIST	1-3
ADDITIONAL INSTRUCTION BOOK	
M-5422 Oscillator Unit	
Helpful General Information	A - E
PHOTOGRAPHS	
DRAWINGS:	
810 4339 001 - Detail Control Circuit	
813 9110 001 - Frequency/Load Determined Components	
813 9191 001 - Transformer Connections	
842 3887 001 - Overall Schematic	

SPECIFICATIONS

Rated Power Output	250 Watts
Capable Power Output	280 Watts
Frequency Range	540-1600 KC (as ordered)
R.F. Output Impedance	30-300 ohms (as ordered)
Frequency Stability	± 5 cycles
Carrier Shift	3% or less at 95% modulation
Audio Distortion	3% or less 50 - 7500 cycles, 90% modulation
Audio Response	± 1-1/2 DB 30 - 10,000 cycles ± 2 DB 30 - 12,000 cycles
Residual Noise	At least 55 DB below 100% modulation
Audio Input Impedance	500/600 ohms
Audio Input Level	+ 8 DB ± 2 DB for 100% modulation
Primary Supply	230 Volts, 2 wire, 50/60 cycles
Power Consumption	1.6 KW at 95% modulation
Size	78" high, 34" wide, 33" deep
Weight and Cubage	900 pounds packed; 112 cubic feet
Tubes:	Oscillator - 12BY7A 1st IPA - 12BY7A 2nd IPA - 813 Power Amplifier - 810 (2) Audio Driver - 6L6G (2) Modulator - 810 (2) Main Rectifier - 8008 (2) L.V. Rectifier - 5V4GA

SECTION I

INTRODUCTION

The Gates BC-250GY Transmitter is a modern high fidelity transmitter having every modern feature demanded by the modern radio broadcasting station. When properly installed and maintained it will give years of trouble-free service.

The F.C.C. rated power of the BC-250GY transmitter is 250 watts and is officially approved on the records of F.C.C. as a Gates Radio Company Model BC-250GY Transmitter for amplitude modulation.

The radio frequency range of the BC-250GY transmitter is from 540 to 1600 KC. In each case specific frequency determining components are supplied for operation of the transmitter on the frequency specified when ordering. In certain rare situations of critical antenna loading, the calculated frequency determining components could be in error, making resonance and/or loading of one or more circuits not complete. In such cases advise the factory immediately.

The radio frequency output can be arranged to match a resistive load from 30 to 300 ohms, but can not do so with a single set of components. It is also essential that in placing the order, the load impedance be specified. If this load impedance also is reactive, such as with a direct fed tower, compensating components will be required.

The radio transmitter unit is only one part of the station installation. Each station has its own individual requirements dependent on the plan of operation, location, etc. The Consulting Engineer usually plans the transmitter and antenna system. At times, additional special equipment will be desired. For this, consult with the Gates Sales Engineering Staff, either the field representative or at the factory office.

SECTION II

BC-250GY-1 TRANSMITTER DETAILS

The following information on the BC-250GY transmitter pertains to the general construction and operational detail surrounding the transmitter itself. As in all modern transmitting equipment it is best to look at the transmitter in its various sections as pertaining to overall performance detail.

Oscillator Unit

The oscillator unit is located on the inside left of the cabinet, facing the back, directly below the 813 intermediate amplifier stage. This is the standard Gates M-5422 Oscillator Unit, using vacuum crystals. It can be readily removed by loosening the four mounting screws, and unplugging the connecting cable.

The operation of the M-5422 oscillator unit is explained in detail in a separate section of this instruction book. The filament and plate supply are obtained from a power supply on the audio driver chassis; a part of this supply also is used for the modulator bias voltage. A voltage divider delivers approximately 150 volts to the M-5422 oscillator unit, and with this voltage the unit delivers ample power to drive the following 813 stage.

The 813 stage is equipped with a grid current meter M8, mounted on the 813 chassis. The M-5422 oscillator unit, which is operating when the filaments are on, can be tuned according to instructions for the maximum grid current reading on the meter M8. This will be approximately 8 - 10 milliamperes without voltage on the plate of the 813. The vacuum crystals have zero temperature characteristics, and are operable on frequency as soon as the tubes heat to normal emission. Any delay in setting the frequency will be due to the requirements of the frequency monitor having to reach a stable heat level. There are no gaps to set. The crystals are normally received from the supplier after having been calibrated in a M-5422 oscillator unit, and before shipment are retested in the M-5422 oscillator unit supplied with the transmitter. It can be anticipated that the frequency will be within a very few cycles of the specified frequency, within the range of adjustment of the frequency trimmer condensers.

Intermediate Amplifier

The 813 intermediate amplifier is located directly above the oscillator unit (tube V6) and has its associated coil and tuning condenser directly adjacent. The intermediate amplifier tank coil is center tapped to ground with neutralization of the final power amplifier to the opposite end from that of the grid drive end. The screen voltage is obtained through two voltage dividing resistors which are normally set at the factory to obtain approximately 350 volts on the screen, allowing a margin for high line voltage and furnishing ample drive for the power amplifier. The plate current of the intermediate amplifier is indicated on meter M6. The intermediate amplifier tunes to resonance by capacitor C24, in the 813 tank circuit and is tuned to minimum plate current.

On the plate coil L7, the taps (when used) should always be on the same relative tap from the center tap. As much coil and as low value of capacity to tune should be used, except to a point of extremely low capacity which will tend to result in arcing in the condenser.

In case of changing frequency to a new frequency from that previously supplied when manufactured, the following information will be valuable. The tuning ranges will be as follows:
For 1200 KC to 1600 KC use 15 turns on each side of center tap (first tap from center tap). The second tap from center (21 turns) will provide a tuning range from 1500 KC to 950 KC. The full coil provides tuning from 720 KC to 1100 KC. Tuning from 650 KC to 720 KC requires the addition of a 200 mmfd. padding condenser (C41), and from 550 KC to 650 KC, a 400 mmfd. padder.

Power Amplifier

The power amplifier consists of two 810 tubes operating in parallel. The load is connected through a low pass filter to the inductive branch of the tank circuit, a system which minimizes harmonic radiation. The final amplifier is resonated by means of capacitor C33, and brought to exact frequency by the variable capacitor C32. The value of C33 is determined by the carrier frequency and is usually properly provided at time of shipment.

In some instances of unusual loading conditions, particularly very low impedance antennas, the value of tank padding condenser C33, may be affected as applied to normal charts and if the amplifier will not resonate with the load applied, it would be the antenna and would only be in case of direct coupling, information as to the antenna or loading characteristics should be immediately supplied to the factory.

Audio Chassis

The audio chassis is the hinged chassis on the right hand of the cabinet facing the rear and accommodates the push-pull 6L6G (1622) Class A audio driver, the push-pull Class B 810 modulator tubes on the top of the chassis and also accommodates the combination oscillator-bias supply and its associates 5U4G tube and the vacuum type time delay relay E6. The output of the 810 modulator tubes terminates to modulation transformer T3, located in the bottom of the cabinet. The plate voltage to the 6L6G tubes is approximately 375 volts. The modulator tubes operate at the full plate voltage of the main power supply.

For under-chassis servicing of the audio deck, it is only necessary to remove the knurled thumb screws and this chassis hinges back revealing all under-chassis wiring and components for fast servicing where required. It should be noted that the oscillator bias power supply is so constructed that 60 volts is taken from the negative side of this supply to provide bias voltage for the modulators, which is individually adjustable by bias resistors R4 and R5.

Relays

The thermal operating filament time delay relay is mounted on the audio chassis; the control element being connected across the filaments of the 6L6G tubes. In case of breakage of the time delay relay by accident or failure, to resume operation a temporary expedient can be had by removing the time delay tube from the audio chassis and placing a jumper between terminals 67 and 68. In this way there is no time delay action and the overloads may trip from a cold start. This is usually due to the bias voltage not having obtained full value. By waiting a few seconds after the initial start no trouble will be encountered. Using the transmitter without the time delay tube, of course, is not recommended and the above is mentioned only for servicing and emergency procedure.

The modulator and power amplifier stages have overload relays in the filament return circuits. These are normally open. When the current becomes sufficient, the contacts close, completing the circuit through an auxiliary relay with normally closed contacts in series with the high voltage contactor coil. Under normal operation, modulation may provide sufficient current to cause the overload armature to pull open. If normally closed contacts were used to operate directly in series with the plate contactor coil, these modulation cycles would cause the contactor to chatter, or possibly drop out, although no overload actually occurs. Both overload relay coils are shunted by adjustable resistors for setting the overload current point. The normal unshunted operating current is 300 MA and shunting with resistors gives a higher current rating. Increasing the amount that is shorted out on the resistors R27 and R28, raises the current required to trip the respective relay. The relays should trip at about 400 milliamperes, heavy enough that the power amplifier overload does not trip with normal tuning and the modulator overload does not trip with normal program. In the case of the modulators, the resistors also load the inductance of the coil, preventing distortion through this element.

8008 Rectifier Tubes

The 8008 mercury vapor rectifier tubes are sensitive to temperature. If the temperature is too high or too low, this type of tube has a tendency to "arc-back" or conduct current in the reverse direction, resulting in a high voltage short circuit. When the transmitter is operated where temperature is a problem, such as unattended and in a unheated building, or where the temperature may become excessive, the mercury vapor rectifier tubes may be directly replaced by a type using xenon or some other inert gas and which is not nearly so sensitive to temperature, or with minor modifications by semi-conductor rectifiers.

Another solution is to install a heating element inside the transmitter cabinet with a thermostat control such as used for furnaces, adjusted so that when the temperature drops below a certain value such as 75 degrees, the heating element will be energized. Similarly, if high temperature is a problem, an exhaust fan could be installed in the top of the transmitter, with the thermostat operating when the temperature reached a value of around 95 degrees. Operation of this equipment with mercury rectifiers is NOT recommended above 120°F or below 45°F ambient.

Transformers

Several of the transformers are provided with voltage change terminals. With these transformers, one side of the incoming a.c. line always connects to terminal #1. The other side connects to terminal #3 for normal voltage output on the secondary at the specified load. The secondary voltage may be raised by connecting to terminal #2 instead of terminal #3, or lowered by connecting the line to terminal #4 instead of connecting to terminal #3. Transformer diagrams are included elsewhere in this operating manual.

Wiring Detail

The power line connections are made directly to the fuse block A7. Most wiring regulations require a service switch with fuses. The local regulations should be checked so that the initial installation will meet all requirements. The maximum normal transmitter load current is 8.5 amperes. The wire size should be #8 or #10. This transmitter requires 230 volts a.c. single phase power source. It will not operate on a 208 volt power source without modification, but is designed to operate either on 50 cycles or 60 cycles.

The audio input line connects to the terminal board at the bottom rear of the modulator panel (right side, facing from rear). This should be a shielded pair. The transmitter input is 500/600 ohms, working equally well with either ohmage. Other input impedances may be had by changing primary taps on the input transformer T8. If the output amplifier to the transmitter does not have an output pad, it is advisable to insert a fixed "H" pad, 500/500 ohms having a loss of 5 or 6 DB to assure no reaction between transmitter and amplifier and to introduce no errors in frequency response.

The frequency monitor jack is fitted for a single pin connector located on the radio frequency side panel at the bottom rear. The modulation monitor connection is for a two pin connector. Both pins are connected together. This insures that the two lines will not be connected wrong. Small size co-axial cable should be used. Sometimes audio cable is tried, the losses and capacities are so high that seldom are the results satisfactory.

The transmitter cabinet should be well grounded. The cabinet itself should be grounded by cable to meet underwriters' regulations. The radio frequency output, which is the cabinet stud on the top of the cabinet adjacent to the feedthru bowl, should go to the radio system ground. At least a 2" copper strap is recommended. In some installations, this lead might be dressed down inside the transmitter, behind the side panel to the base, and connecting to a strap from there to the system ground.

Connecting the Load

The coaxial or open wire transmission line or the direct coupled antenna connects to the feedthru insulators on the top of the transmitter. In the case of coaxial transmission line or open wire transmission line, the ground portion of the transmission line should be firmly secured to the top of the cabinet also, so that the ground path will not have to travel through the transmitter cabinet. Where desired, the coaxial transmission line may be brought up through the bottom of the cabinet at any number of the convenient locations as will be quickly obvious to the installing engineer's eye.

SECTION III

INITIAL TUNE-UP

General Operational Procedure

Before proceeding with the initial tune-up let us recheck the necessary things to be done before any voltage is applied to any portion of the transmitter. Briefly, check the following list:

- 1 - Proper line voltage to fuse block A7.
- 2 - Proper location of all tubes in the sockets.
- 3 - Proper termination of the antenna or dummy antenna equipment.
- 4 - Removal of all tie-down straps and other materials used for shipping purposes.
- 5 - A recheck to be sure components removed for shipment have been installed properly.
- 6 - Complete check of the transmitter with a screwdriver and wrench to be sure all bolts, screws and other connections that could possibly work loose in shipment have been brought down securely.
- 7 - Looking over all wiring for broken solder connections, making sure that everything is secure.
- 8 - Making certain the transmitter is well grounded and that the ground to the transmitter is tied to the main ground of the antenna system. THIS IS VERY IMPORTANT. AT LEAST 2" COPPER STRAP RECOMMENDED.
- 9 - Making certain that transformers with voltage correction taps have one side of the supply line connecting to terminal #1.
- 10 - Making sure audio wiring has been properly shielded and that the shields have been properly grounded, and that no input wire runs in the same cable as an output wire or a power cable.

In case the transmitter is located on the upper floor of a building, particular attention must be paid to grounding of the equipment. Additional ground busses and elimination of varied ground potentials is highly important for good performance and low noise.

With the transmitter ready to operate, the service switch is closed and power supplied to the transmitter. Pressing the "Filament ON" switch S1, lights the tube filaments and the power supply for the M-5422 oscillator unit. The oscillator unit is tuned according to the directions given in the instructions for this unit. When the transmitter has been factory

tested on frequency, this should amount to no more than a check on the tuning. The 813 stage is provided with a convenient grid current meter, and the oscillator tuned for maximum grid current, which should be 8 - 10 milliamperes with no voltage on the plate of the tube.

Before applying the high voltage, set the modulation monitor pick-up coil L12, for minimum coupling, at right angles and as far removed from the tank coil as possible so as not to overload the modulation monitor input. Set the two modulator bias rheostats R4 and R5 to maximum bias voltage, that is, fully counterclockwise. Set the neutralizing condenser C28 at half capacity. Remove the plate connector from one of the 8008 rectifier tubes, making sure the connector is not grounded.

Disconnect the primary of the plate transformer T1, terminals 1 and 2 or 3 whichever is used. When the filaments have been on 30 seconds, the time delay relay E6 closes and the "FILAMENT" light will light. With the back door closed, pressing the high voltage "ON" switch S2 should cause the plate contactor E4 to close. Pressing the high voltage "OFF" switch should cause this contactor to open. With the contactor closed in the high voltage ON condition, opening the back door should cause the contactor to open.

Opening the door and blocking or holding the door interlock switch S4, the high voltage control can then be closed. With a wooden dowel or insulating stick, push the armatures of the overload relays E1 and then E2. In each case the auxiliary relay E3 should operate and cause the plate contactor to open. CAUTION: The armatures of these relays are in the 220 volt circuit and should NEVER be touched with the body.

If the control circuit does not operate as described, some fault exists and should be remedied before continuing. With the high voltage transformer disconnected, no damage to equipment should be incurred while testing the control circuits.

With the control circuits functioning properly, the high voltage transformer may be reconnected, and the radio frequency circuits adjusted.

9/11/63

Tuning Procedure

Close the filament start switch which turns on filament and oscillator. Set the filament voltage to 10 volts with the filament rheostat. When the 30 second time delay relay E6 closes, and if the rear door is closed, high voltage may be applied by pressing the "High Voltage ON" switch. With one rectifier tube disconnected, slightly under half plate voltage will be obtained. Tune the R.F. driver control C24 for minimum current on the R.F. driver current meter M6. With the reduced voltage, this should be 40 - 60 milliamperes. At the same time, the power amplifier grid current meter M3 should show a reading of 30 - 60 milliamperes.

The power amplifier tuning C32 can then be adjusted for a minimum current reading on the plate current meter M4. This value should be 100 - 120 milliamperes. The amount of current can be controlled somewhat with the "Loading" control C34. Output current should be indicated on the R.F. Line Current meter M1, and should be approximately half the value for the particular transmitter load given in the tabulation of "TYPICAL VOLTAGE CONDITIONS" included in this instruction book.

The power amplifier shows no tendencies for parasitic or self-oscillations, so no concern need be felt on applying plate voltage without the stage being completely neutralized. Neutralizing may be quickly and effectively done by tuning the plate condenser C32 through the minimum current dip to 10 or 20 milliamperes on each side, and watching the grid current as registered on the meter M3. When first tried, the grid current may show a slight increase on one side or the other of the minimum plate current dip. Slowly moving the neutralizing condenser C28, tune back and forth across the resonance dip with the plate tuning until a setting for the neutralizing condenser is found where the current does not increase when the plate is tuned off resonance. The opposite side will show a pronounced decrease of grid current. The main criteria is that the grid current shows no increase from the minimum plate current point on either side of resonance, and decreases if sufficient detuning is possible.

Shutting down the transmitter, the plate connection is again made to the 8008 rectifier tube. High voltage may then be re-applied, and the transmitter adjusted to the final loading condition. Typical readings are given in Section IV of this instruction book.

If a severe overload occurs with the application of high voltage, note if the modulator current reads excessive. With a voltmeter, measure the voltage on the modulator grids. This should be negative 50 to 60 volts to ground if the bias potentiometers are turned to the maximum bias voltage position. If the bias is higher than 30 volts, the overload may be caused by a reversed audio feedback loop causing high frequency oscillations. Removal of the connections to the plates of the modulator tubes will stop the overload. The remedy is the reversal of the connections to terminals 81 and 83, or a temporary correction can be made by reversing the grid or plate connections of the 810 modulator tubes.

It is difficult in these instructions to give loading information as various types of loads are applied in almost each broadcasting installation. Where a 70 ohm transmission line is provided, the line current meter M1 is usually 0-3 amperes, while for a 250 ohm transmission line meter M1 is usually 0-2 amperes. The formula of I^2R is usually employed in computing the proper line current where the line impedance is known, and of course, is likewise employed where the antenna resistance is known in the case of direct coupling. A dummy antenna of known value is usually preferable in the initial tune-up so that it can be determined whether the transmitter is functioning properly and thus, full attention can be given to the antenna loading problems for final successful operation. The Ohmite D250 dummy antenna for 73 ohms operates excellently where the transmission line is 73 ohms. Or, in the case of 250 ohm transmission lines, four of these dummy antennas may be wired in series which will give slightly higher resistance than the open wire transmission line, but usually will be satisfactory as the resistance is known.

As a less satisfactory dummy antenna, 150 watt lamp bulbs may be employed which have a resistance of about 100 ohms, but are not dependable as their resistance will vary with intensity. Two may be paralleled to give a 50 ohm dummy antenna or three may be in series to give a 300 ohm dummy antenna. One in series with two in parallel will give approximately 75 ohms. Two series

connected in series with two parallel connected will give approximately 250 ohms. As light bulbs are highly reactive, the actual load will be considerably removed from the proper condition but will serve to allow a good preliminary checkup. As the power amplifier tank circuit is directly affected by the load, it is well to discount this in the subject of loading conditions. The power amplifier tank is usually provided with a padding capacity C33 in addition to the variable tuning capacity C32. The tank capacity and the coupling capacities C34 and C35 determine the harmonic suppression, a chart of recommended values for various frequencies and common loadings is given elsewhere in this instruction book. Special loading conditions may require modification, and frequently the addition of a series condenser. In this latter case, the condenser is between the line coil L11 and meter M1. The proper loading of the transmitter to the particular condition must be admitted as more or less on a cut-and-try basis, adjusting C34 and the taps on coil L11; maintaining the final power amplifier in complete resonance will eventually produce the desired results where the load is not below 30 ohms or exceeds 300 ohms. Final current into the line load on the formula I^2R is, of course, the answer to the correctness of the load. The efficiency of the BC-250GY transmitter is 70% and seldom over 75%. It should be remembered that efficiency is measured into a known load, and preferably a resistive load designed for radio frequency operation. It should also be remembered that a radio transmitter of standard construction is not normally inefficient when, of course, properly adjusted and tuned. Thus, lack of efficiency in operation can usually always be attributed to lack of proper loading conditions to the transmitter itself, which is usually indicated by unbalanced line currents in the case of a transmission line, and of course, can be checked by making sure ground connections to the transmitter are well made directly to the radiating system of the antenna. Abnormally high efficiency is quite frequently found to be in the antenna system. This may be checked if a dummy antenna of equivalent resistance is substituted for the line or antenna. It may be found that the line current meter is measuring reactive currents, which would give a false impression of efficiency.

When the power amplifier and R.F. Driver have been tuned, the modulator currents may be set. With the two bias potentiometers R4 and R5 turned fully counter-clockwise, there should be little if any current indicated on the modulator current meter M2. Turn one potentiometer until this meter shows 30 milliamperes current, then bring the other potentiometer to a reading of 60 milliamperes. The modulation monitor pick-up loop may now be adjusted. This should be only enough to give just over the requirements of the modulation monitor so that the modulation monitor "Carrier Set" control is almost at maximum.

Making Performance Measurements

To make satisfactory noise, distortion and response measurements, it is necessary to have the proper measuring equipment. The Gates SA-131 Proof of Performance kit contains the required instruments for making these measurements. Checking noise or signal quality by means of a radio receiver in the same room as the transmitter is generally not satisfactory, as quite often overloading of sensitive circuits, or stray pickup, introduces effects in the receiver which do not indicate the exact performance obtained. The use of the SA-131 kit is fully explained in the instruction book for the set.

The Gates M-5693 Modulation Monitor has provisions for making performance measurements, other monitors may or may not have this provision. Before accepting adverse readings when using a modulation monitor as the diode source, determine the monitor is suitable for this use. For normal program monitoring, the pick-up from the power amplifier tank coil is satisfactory, but it may be found that better results are obtained from a pick-up loop coupled to a temporary turn or two in the radio frequency output line. The amount of coupling to the diode may have considerable effect. Generally, the coupling should be such that with 100% modulation the distortion meter calibrate dial will be at about one-half to two-thirds of the scale.

Preliminary performance measurements need be made on only three frequencies, 50, 1000 and 5000 cycles. 50 cycles represents the low frequency end, 1000 cycles the mid-frequency and best performance, 5000 cycles the high frequency end, this frequency is frequently higher in distortion than 7500 cycles.

Distortion readings on these three frequencies can be taken. Then with the 50 cycle frequency, hold the back door interlock, apply the high voltage, and set for the distortion reading. Then adjust the bias potentiometers for distortion below 3%, but not necessarily the minimum possible distortion, as this adjustment may increase the noise and distortion on other frequencies. After this adjustment is made, recheck the other two frequencies and the noise level. When setting the bias potentiometers, extreme caution should be used, with preferably a second person helping. If the performance is within specifications, a complete frequency run may be made.

In case the distortion or noise is out of specifications, several remedies may be tried. Different tubes may be tried, particularly the 6L6G audio driver and 810 modulator tubes. Because a tube is new out of a carton is no guarantee that it has not received some damage in shipping.

The polarity of the modulation transformer may be reversed by inter-changing the two modulator tube leads on the primary of the transformer and connecting whichever way gives the best results for all frequencies. The modulator grid connections could be interchanged, and doing this requires that the feedback also be reversed. Both reversals, that is, the driver and modulator could be tried simultaneously. In each case, the modulator bias should be adjusted for 50 cycle distortion below 3% if obtainable.

Some noise improvement can be obtained by proper phasing of the audio system by the means just outlined so some cancellation is obtained between the audio and radio frequency sections, but this can easily upset the distortion performance. Considerable noise variations can be encountered in the tuning of the radio frequency part of the transmitter. Normally, the best noise reading will be obtained when the 813 driver stage is tuned to the minimum plate current. The power amplifier neutralizing has some effect. If the radio frequency drive is low in any of the radio frequency stages, some grid modulation is fed through to cause the noise. The phasing mentioned is that the noise generated in the audio section is opposed to that generated in the radio section resulting in cancellation with the residual being the difference of the two magnitudes.

The transmitter is thoroughly factory tested, and the phasing and polarity selected for best performance. When components are removed for shipping, the connections are tagged so that the same connections may be made again. Should any deviation occur radically outside specifications, this may be due to damage to components or tubes during shipping, or to a mis-interpretation of connection instructions. If after a period of operation, the performance is outside specifications, this may be due to tubes or to some component aging, such as a resistor changing value.

9/11/63

-15-

BC-250GY-1

SECTION IV

TYPICAL VOLTAGE AND CURRENT CONDITIONS OF BC-250GY-1 TRANSMITTER

These readings are average and subject to variation:

(a) - 6L6G Audio Driver

Plate Voltage	330 V.
Screen Voltage	230 V.
Total Cathode Current	110 MA.
Cathode Voltage	14 V.
Filament	6.3 V. A.C.

(b) - Modulators

Plate Voltage	1400 V.
Total Static Plate Current (M2)	50 - 60 MA
Bias (approx.)	-32 - -36
Filament M7	10 V. A.C.

(c) - M5422 Oscillator

Plate Voltage	145 - 160 V.
Filament	6.3 V. A.C.

(d) - 813 RF Driver

Plate Voltage	1400 V.
Screen Voltage	350 - 400 V.
Cathode Current (M6)	120 - 160 MA.

(e) - Power Amplifier

Plate Voltage (M5)	1250 - 1350 V.
Plate Current (M4)	246 MA. (typical only, will vary)
Filament	10 V. A.C.
Grid Current (M3)	70 - 120 MA.

(f) - Line Current (M1) (250 watts output)

250 ohm load	1 amp.
72 ohm load	1.84 amp.
50 ohm load	2.24 amp.

Conclusion

A radio broadcast transmitter, regardless of its size, cannot be fully described in an instruction book such as this as to every possible condition that may arise in the process of installing and placing into operation. There have been provided on the following pages, numerous drawings showing the entire transmitter construction and also pictures showing the parts as to their location in the transmitter. In preparing the instruction book it has been recognized that the installing engineer undoubtedly

is very familiar with general broadcast equipment procedures and that many of the things referred to are well known by him. It is suggested, therefore, that the installing engineer, and likewise, the personnel who will use the transmitter, not only familiarize themselves with the instruction book as provided, but more important with the transmitting equipment itself. The Gates Radio Company in designing the BC-250GY transmitter has done everything to provide the finest equipment available today. It is not possible for us to provide the location, the antenna, and the ground system. Many other accessories to be used with the equipment can be found in the latest Gates catalog. The use of good engineering practice and sound fundamental reasoning will develop the desired high quality results possible from this equipment.

It is repeated again, make a good installation, eliminate haste and in so doing keep the record of failures a blank on a log book. Also remember that cleanliness in the maintenance of the broadcasting equipment will pay big dividends. Take a period each week for cleaning the inside and outside of the transmitter and accessory equipment, for testing tubes, making sure all connections remain solid, and the many other things that are entitled good maintenance. In so doing, happy and satisfactory performance from Gates broadcasting equipment will result. In case of any problem that is perplexing to you, feel free to contact the Engineering Department of the Gates Radio Company who will gladly cooperate with you in every way to obtain the most satisfaction from your Gates equipment.

WARRANTY

The Gates warranty, gladly supplied in detail on request, generously covers all materials when returned to the Gates factory for inspection, transportation paid. Certain moving parts and tubes are guaranteed usually on an hourly basis and that of the manufacturer's guarantee. This warranty does not extend to free service in the field, but this service is available at a modest cost, where required.

9/11/63

-17-

BC-250GY-1

PARTS LIST

<u>Symbol No.</u>	<u>Gates Part No.</u>	<u>Description</u>
A3	406 0038 000	Pilot Light Assembly, Green
A4, A6	396 0015 000	Lamp, S6, 10 W. 230 V.
A5	406 0037 000	Pilot Light Assembly, Red
A7	402 0037 000	Fuseblock, 2 pole
A13	402 0021 000	Fuseholder
C1	510 0507 000	Cap., 10 mfd., 2000 W.V. 126,
C3	510 0503 000	Cap., 1 mfd., 1500 W.V.
C4, C5	524 0041 000	Cap., 40 mfd., 150 V.
C6	506 0024 000	Cap., .5 mfd., 600 W.V.
C7	524 0048 000	Cap., 20 mfd., 450 V.
C8, C9	506 0009 000	Cap., 2 uf., 200 V.
C10, C46	510 0345 000	Cap., 4 mfd., 600 W.V. (Term. insulated)
C21	500 0670 000	Cap., .005 mfd., 1200 W.V.
C22, C23	500 0646 000	Cap., .002 mfd., 600 W.V.
C24	520 0041 000	Cap., 500 mmfd., Var.
C26	500 0681 000	Cap., .0015 mfd., 2500 W.V.
C27		Cap., 2500 W.V. (Det. by Freq.)
C28	520 0277 000	Neutralizing Condenser, 6-12 pf.
C29, C30	500 0655 000	Cap., .02 mfd., 600 W.V.
C31	504 0037 000	Cap., .001 mfd., 5000 W.V.
C32	520 0045 000	Cap., 250 mmfd., Var.
C33		Cap., G1 (Value det. by Freq.)
C34	520 0041 000	Variable Condenser, 500 mmfd.
C35, C36		Cap., G1 (Value det. by Line Impedance)
C41		Cap., (Value det by Freq.)
C42, C44	516 0024 000	Cap., 75 uuf., 1 KV
E1, E2	574 0045 000	F.A. & Mod. Overload, SPDT, 2.2 ohms, 300 MA closing
E3	574 0012 000	Overload Aux. 220 V., 60 cy. Coil, normally closed
E4	570 0080 000	Plate Relay, 2 pole Coil, 220 V., 60 cycle
E6	576 0001 000	Time Delay Relay
F1, F2	398 0231 000	Fuse Plug, 10 amp., 125 V.
F5	398 0019 000	Fuse, 2 amp., 3AG
J1	612 0230 000	Connector, Single (Female)
J2	612 0231 000	Connector, Double (Female)

PARTS LIST

<u>Symbol No.</u>	<u>Gates Part No.</u>	<u>Description</u>
L1	476 0174 000	Swinging Choke
L2	482 0001 000	Modulation Reactor
L3	494 0101 000	R.F. Choke
L4,L5	476 0083 000	Choke, 8 hy., 80 MA
L6	931 6138 049	Plate Tank Coil, 87FA4634
L7	938 0722 001	813 Tank Coil Assembly
L9	494 0020 000	R.F. Choke, 2.5 Mh.
L10	494 0070 000	R.F. Choke
L11	938 0748 001	Antenna Coil Assembly
L12	910 4155 001	R.F. Mon. Coup. Coil Assy.
L13	910 7033 001	Parasitic Suppressor
L14		Part of L13
M1		R.F. Line Current Meter, Int. Thermo (Det. by Line Impedance)
M2,M4	632 0124 000	Mod. & P.A. Plate Current Meter, 0-500 MADC
M3,M6	632 0300 000	P.A. Grid & R.F. Driver Plate Current Meter, 0-200 MADC
M5	632 0136 000	P.A. Plate Voltage Meter, 0-1 MADC movement w/0-2500 V. DC Scale
M7	630 0115 000	Fil. Voltage Meter, 0-15 V. AC
M8	632 0525 000	813 Grid Current Meter, 0-25 MADC
P2	612 0099 000	Plug
P3	610 0231 000	Connector (Male) for J1
P4	610 0233 000	Connector (Male) for J2
R1	552 0391 000	Potentiometer, 1000 ohms, 100W.
R2	542 0209 000	Res., 200 ohms, 50W. W.W.
R3	914 3421 001	Meter Multiplier, 2.5 megohm
R4,R5	552 0321 000	Potentiometer, 1500 ohms
R6	542 0754 000	Res., 15K ohms, 2 W. 10%
R7	542 0458 000	Res., 125 ohms, 10 W.
R8,R9	540 0642 000	Res., 20K ohms, 1 W. 5%
R10,R11	540 0202 000	Res., 100K ohms, 1/2 W., 10%
R12	542 0368 000	Res., 7500 ohms, 200 W.
R13	542 0303 000	Res., 10K ohm, 100 W.,
R14,R15	542 0084 000	Res., 3000 ohms, 10 W. W.W.
R16	542 0184 000	Res., 2500 ohms, 25 W.
R17	542 0182 000	Res., 1500 ohms, 25 W.
R20	542 0088 000	Res., 5000 ohms, 10 W. W.W.
R21	542 0228 000	Res., 20K ohms, 50 W.
R22	542 0309 000	Res., 50K ohms, 100 W.

PARTS LIST

<u>Symbol No.</u>	<u>Gates Part No.</u>	<u>Description</u>
R23	542 0300 000	Res., 3000 ohms, 100 W. Lug Type, W.W.
R24	552 0381 000	Potentiometer, 16 ohms, 100W.
R25, R26	542 0089 000	Res., 6000 ohms, 10 W.
R27, R28	552 0006 000	Res., 10 ohm, 10 W. Adj.
R29	542 0209 000	Res., 200 ohms, 50 W. Lug Type, W.W.
R30	542 0154 000	Res., 50K ohms, 20 W. W.W.
R33, R34	540 0642 000	Res., 20K ohms, 2 W., 5%
R40, R41, R42, R43, R44, R45	540 0670 000	Res., 300K ohms, 2 W., 5%
S1	604 0116 000	Switch, Double P.B. DPST
S2	604 0136 000	Switch, Double P.B.
S4	604 0073 000	Door Interlock Switch
T1	472 0234 000	Plate Transformer
T2	472 0211 000	Filament Transformer
T3	478 0062 000	Mod. Transformer
T4	472 0182 000	Filament Transformer
T5	472 0199 000	Filament Transformer
T6	472 0171 000	Filament & Plate Transformer
T8	472 0142 000	Input Transformer
T9	478 0038 000	Driver Transformer
TB1	614 0241 000	Terminal Board, 20 term.
TB3, TB8	614 0111 000	Terminal Board, 3 term.
TB4, TB11	614 0092 000	Terminal Board, 2 term.
TB5	614 0241 000	Terminal Board, 20 term.
TB6	614 0100 000	Terminal Board, 10 term.
TB6A	614 0118 000	Terminal Board, 10 term.
TB7	614 0096 000	Terminal Board, 6 term.
TB8A	614 0093 000	Terminal Board, 3 term.
TB9	614 0047 000	Terminal Board, 3 term.
TB10	614 0052 000	Terminal Board, 8 term.
V1, V2	370 0086 000	Tube, 6L6G
V3, V4, V7, V8	374 0031 000	Tube, 810
V6	374 0034 000	Tube, 813
V9	370 0230 000	Tube, 5V4GA
V11, V12	374 0058 000	Tube 8008
X1, X2, X9, X10	404 0016 000	Socket
X3, X4, X7, X8	404 0056 000	Socket
X6	404 0053 000	Socket
X11, X12	404 0121 000	Socket

SPECIFICATIONS

Frequency Range: 1600 Kc to 540 Kc.
Crystals: 2 Vacuum Crystals.

Frequency Tolerance: ± 5 cycles, typical ± 2 cycles.
Supply Voltages: 18-210 Volts D.C. @ 10 MA.
6.3 Volts A.C. @ 1.2 Amps.

Output Impedance: High Z (capacity coupled).
Tubes: 2 Type 12BY7A.

TUNING PROCEDURE FOR THE M5422 OSCILLATOR

The following tuning instructions should be followed when placing the M5422 oscillator in operation. If this procedure is not followed, it is possible to tune the oscillator to the 2nd harmonic of the crystal rather than the fundamental.

Information that follows was obtained with the M5422 oscillator connected to its proper R.F. load and 30 feet of RG-62/U cable connected to the monitor terminal #6 with shield to ground or terminal #7.

RG-62/U cable runs 13.5 uufd. per foot, or a total of approximately 400 uufd. effective capacity on the 30 foot length. Shorter lengths of cable on frequencies above 600 Kc will effect the tuning of the unit. More tuning capacity (C9) or more turns of the slug in L3 may be required for resonance.

Shorter lengths of monitor cable on frequencies from 600 Kc to 540 Kc may prevent the unit from tuning to resonance. If this is the case, capacity should be added across the cable to make up the difference in effective capacity. Longer lengths of cable would mean less capacity or less inductance needed for resonance in this frequency range.

It is recommended that the proper length of RG-62/U be used whenever possible.

FREQUENCIES FROM 1600 KC TO 800 KC.

1. NO PADDING needed in this range.
2. Make sure that slug of L3 is screwed all the way out.

From 1600 Kc to approximately 1100 Kc, tune C9 for dip in plate current or peak in grid current of following stage. If C9 does not tune through resonance, screw in slug on L3 a turn at a time until resonance is obtained with C9. 800 Kc is tuned with C9 near maximum capacity and slug on L3 screwed in 7 turns. If above procedure is not followed it will be possible for crystals from approximately 900 Kc to 800 Kc to tune to their 2nd harmonic if slug in L3 has not been screwed down to approximately 7 turns for 800 Kc.

FREQUENCIES FROM 540 KC TO 800 KC

1. The padder (C11) 100 uufd. located on bottom of L3 must be connected in the circuit.
2. Slug on L3 should be screwed down 14 turns.

Frequencies from 540 Kc to approximately 600 Kc can be resonated with C9. If complete resonance can not be obtained on C9, screw slug on L3 back out a turn at a time until resonance is obtained by tuning C9. At 800 Kc resonance will be with C9 near minimum capacity and slug of L3 screwed out approximately 7 turns from starting point (14 turns down).

CAUTION - If above procedure is not followed and padder not connected, it will be possible to tune crystals from 540 Kc to 800 Kc to their 2nd harmonic.

After resonance has been obtained, the crystal may be set to exact frequency by using the frequency monitor. Set the slots of the trimmer condensers, located on the front of the unit, at right angles to the plane of the trimmer mounting screws. With the crystal selector switch turned to #1 crystal, the frequency should be very close to zero. If not, adjust the trimmer FREQ. #1 until frequency is zero or to point desired for operation. Turn crystal selector switch to #2 position and repeat above operation with trimmer FREQ. #2.

The tuning of these condensers will not effect the resonate tuning of the unit and C9 need not be bothered again. The tuning of C9 will have very little if any effect on the trimmer adjustments.

PARTS LIST

<u>Symbol No.</u>	<u>Gates Part No.</u>	<u>Description</u>
C1,C2	520 0116 000	Cap., Variable, 3.9-50 mmfd.
C3	502 0147 000	Cap., 24 mmfd., 500 (W) V.
C4	502 0094 000	Cap., 800 mmfd., 500 (W) V.
C5,C7,C8	516 0082 000	Cap., .01 mfd., 1000 V.
C6,C11	502 0163 000	Cap., 100 mmfd., 500 (W) V.
C9	520 0119 000	Cap., Variable, 6.7-140 mmfd.
C10	502 0163 000	Cap., 100 mmfd., 500 (W) V.
C12	500 0815 000	Cap., 39 mmfd., 500 (W) V.
J1	610 0047 000	Receptacle
L1,L2	494 0033 000	R.F. Choke, 2.5 mh
L3	492 0019 000	Variable Coil, 105-200 uh
R1,R6	540 0764 000	Res., 100K ohm, 2 W., 10%
R2	540 0740 000	Res., 1000 ohm, 2 W., 10%
R3,R9,		
R10,R11	540 0757 000	Res., 27K ohm, 2 W., 10%
R4	540 0754 000	Res., 15K ohm, 2 W., 10%
R5,R8	540 0752 000	Res., 10K ohm, 2 W., 10%
R7	540 0730 000	Res., 150 ohm, 2 W., 10%
R14	540 0284 000	Res., 10 ohm, 1 W., 5%
S1	913 0316 001	Rotary Switch
V1,V2	370 0123 000	Tube, 12BY7A
XV1,XV2	404 0059 000	Socket, Noval
XY1,XY2	404 0016 000	Socket, Crystal
Y1,Y2		Vacuum Crystal (Det by Freq.)

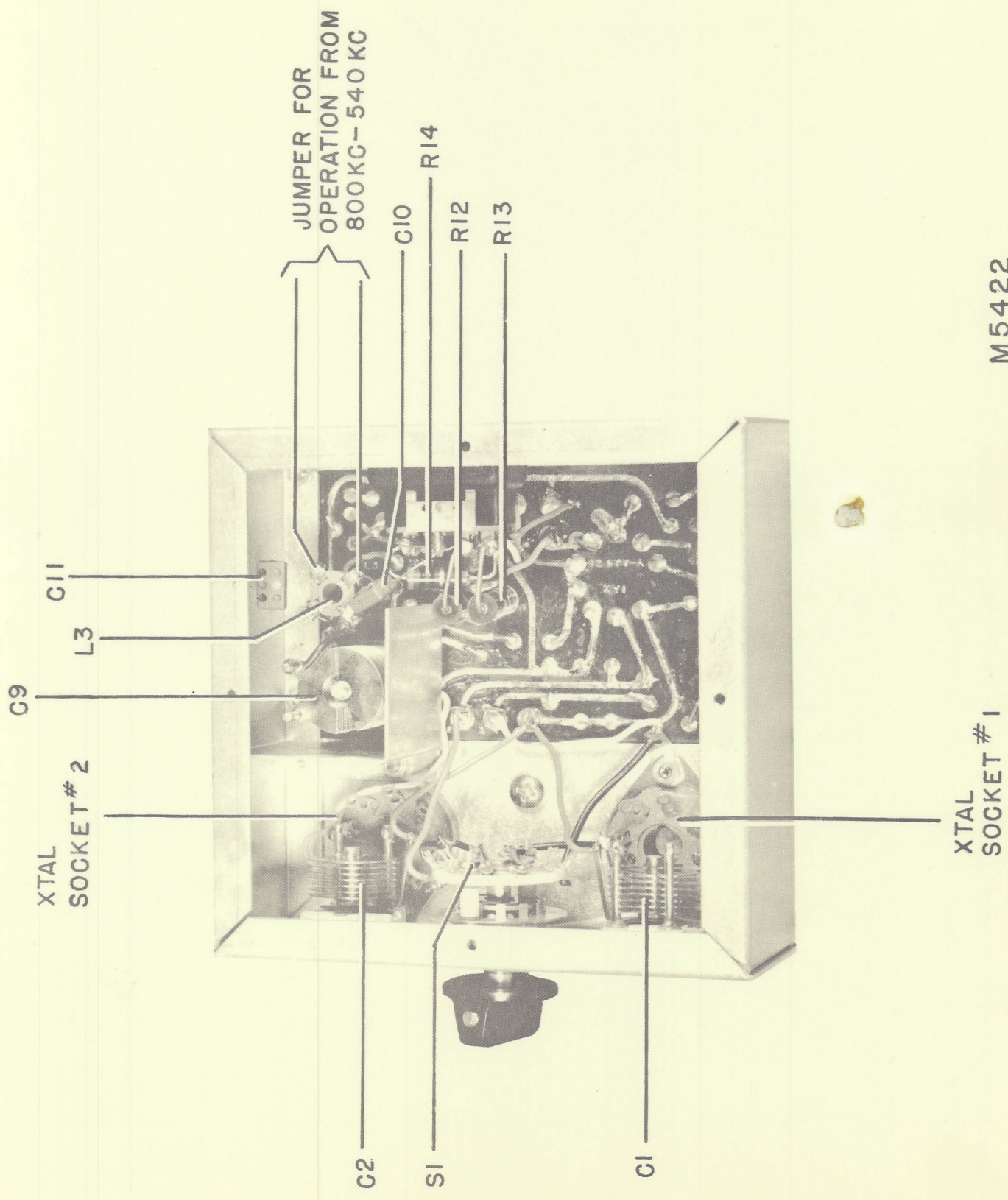

M5422
OSCILLATOR UNIT

DRAWING NUMBER

B-13816

CONNECTION DETERMINED BY FREQUENCY

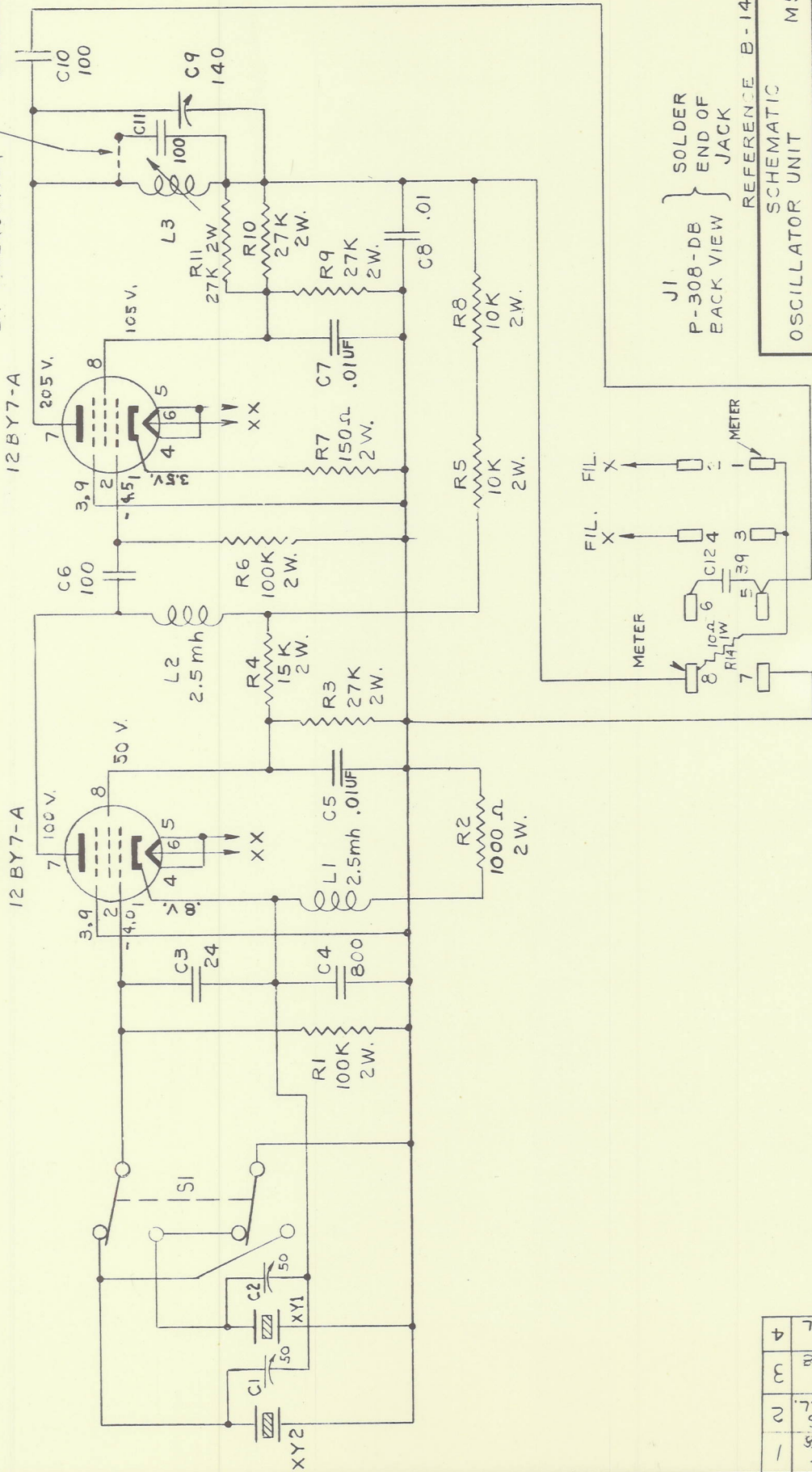

J1 } SOLDER
 P-308-DB } END OF
 BACK VIEW } JACK

REFERENCE B-14041

OSCILLATOR UNIT

M5422

UNLESS OTHERWISE SPECIFIED,
ALL TOLERANCES PER GATES
SPEC GUIDE.

MTL FIN.
 DR. BY D.L. CH. BY DATE ENG. APR. DATE
 DATE 5-3-57

DRAWING NUMBER

B-13816

GATES RADIO COMPANY
QUINCY, ILLINOIS

4	3-13-63 DL
3	ECN 7679
2	SDR 11-17-52
1	ECN 7496
	7-2-58 DL
	ECN 7482
	CTM 6-11-58

HELPFUL GENERAL INFORMATION

This information, of a general nature, will be recognized by many as standard fundamental electronic information. Frequently, when problems exist, one or more of the well known fundamentals may have been overlooked. The following information, therefore, is a check list and/or a suggestion list. You will quickly note it applies to many types of installations, the fundamentals for which are all basically the same.

1. **COMPUTING EFFICIENCY.** The transmitter efficiency determines its satisfactory operation. If it is under-efficient, it will consume excess primary power, will work all components harder and tube life will be shorter. If it is over-efficient, it probably indicates either an error in a computation such as tower resistance measurements or an error in a meter. To measure efficiency in an AM transmitter, multiply the plate voltage by the plate current of the final radio frequency power amplifier. For example, if plate voltage was 2500 volts and plate current was 550 MA, we have:

$$\begin{array}{r} 2500 \\ \times .550 \\ \hline 1375.000 \end{array}$$

The above means that 1375 watts are being placed into the radio frequency power amplifier. If this power amplifier is producing 1000 watts into the antenna, it would then indicate an efficiency of 73% , or

$$\frac{1000}{1375} = 73\%$$

2. **TRANSMITTER EFFICIENCIES.** There are two types of radio frequency power amplifiers. (1) High level and (2) linear amplifiers. Normal efficiency of a high level transmitter ranges from 65 to 77% for transmitters of powers up to and including 1000 watts and 72 to 82% for transmitters having powers of 5000 watts to 10,000 watts. ---- For linear amplifiers with no modulation, the normal efficiency at any power is approximately 30% . It is important to note that in a linear amplifier the efficiency increases under modulation, therefore when defining normal efficiency it must be defined without modulation.

NOTE: Variations in efficiency such as a range of 65 to 77% are expressed for reasons of: (a) transmitter used with directional antenna, which would reduce efficiency, (b) slight but not out of tolerance meter error, and (c) possible mismatch to transmission line having slightly higher than normal standing wave ratio.

If the efficiencies are within the ranges expressed, however, the installation could be considered satisfactory and of course the higher the efficiency, the better.

3. **COMPUTING POWER OUTPUT.** Power output is computed either into the radiating antenna or a known dummy antenna. In either case, the resistance measurements are known. Your consulting engineer will measure your antenna tower and give you the resistance measurement. In most Gates built AM transmitters an inbuilt dummy antenna is provided, having a resistance measurement of 50 ohms. The formula I^2R is employed. I = The current reading of your antenna meter at the tower or the meter to the dummy antenna. R = The resistance measurement of the tower or the dummy antenna. If the resistance measurement is 50 ohms and your antenna current was 4.5 amperes, then I^2R develops this result: $4.5 \times 4.5 = 20.25$. 20.25×50 (the antenna resistance) = 1012.5 watts. In the foregoing you have determined that you have a direct power output reading of 1012.5 watts if your antenna current is 4.5 amperes into a 50 ohm antenna.
4. **CORRECTING LOW EFFICIENCY.** Basically a broadcast transmitter by inherent design can not produce low efficiency unless, of course, it is incorrectly tuned, or the matching load to the transmitter, which is the transmission line and antenna, is incorrect. Here the use of the dummy antenna of known resistance is of great value. Light bulbs or improvised dummy antennas are of little value in computing efficiency. By using the formula in Paragraph 3 above, it is easy to determine how efficient the transmitter is operating when it is not connected to the antenna or transmission line. If the efficiency proves satisfactory into the dummy antenna, then any inefficiency is probably in the match of the transmitter to the radiating antenna and its associated tuning unit and transmission line.

If the efficiency of the transmitter is low into the dummy antenna, check the plate volt meter and power amplifier current meter to be sure they are accurate. In rare cases they are damaged in transit. This checking can be done with another known meter such as a good quality voltohmmeter, being very careful as the voltages are lethal.

Another cause of low efficiency is a defective RF ammeter. If you suspect this, the best way is to borrow one from a nearby station. It does not have to be the exact same range as you are only interested in a comparative reading. Here an error of only .2 of an ampere can make a large difference in the efficiency. Using Paragraph 3 above, again you will note a meter reading example of 4.5 amperes was used to give us

If by the time you have found the trouble you have blown a number of fuses, now investigate your fuse box to be sure the clips are clean and not charred. If they are charred, fuse blowing will continue anyway and it will be necessary to replace the clips that hold the fuses.

11. UNEXPLAINED OUTAGES. This one puzzles the best of them. A transmitter that goes off the air for no reason and can be turned back on by pushing the start button brings the query, "What caused that?" If this happens very infrequently, it is probably caused by a power line dip, a jump across the arc gap at the tower base, or other normal things that activate the protective relays in the transmitter as they should.

Your transmitter always looks like the offender. It is the device with meters and it is the device that complains or quits if there is a failure anywhere in the entire system. An open or short circuit in a transmission line only reacts at the transmitter. A faulty insulator in an antenna guy wire or a bad connection in the tuning unit or ground system reacts only at the transmitter. Here again the dummy antenna is of great value. If these unexplained outages do not appear in operating into a dummy antenna, then you must look elsewhere for the problem. It is always well to remember that the transmission line tuning units and associated connections, including the tower chokes, are somewhat like the drive shaft between the automobile motor and the rear wheels. If the drive shaft fails, it does not mean that the motor is defective.

12. STEP BY STEP TROUBLE-SHOOTING. Never trouble-shoot on the basis of "it might be this or that". Instead, start from the beginning. If the transmitter was satisfactory on the dummy antenna, then the question becomes "Where is the trouble?" If a transmission line connects the transmitter to the antenna coupler, then disconnect the antenna coupler and provide a dummy antenna at the far end of the transmission line and repeat the test. If you noticed the outage at this point, then the trouble is in the transmission line. If not, reconnect it to the antenna coupler unit and put the dummy antenna at the output of the coupling unit. This is known as step by step checking to locate problems.

The same process is used in trouble-shooting the transmitter. In checking voltages, you start with the oscillator and go through to the power amplifier and with the first audio stage to the final audio stage. Other outage conditions not affecting the transmitter are listed below for your checking:

Under certain conditions, especially at higher altitudes, the guy insulators will arc, usually caused by static conditions. This will nearly always cause an outage as it changes the antenna characteristics. This is hard to find as it is hard to see. Use of field glasses at night is the best way. If it happens, the insulator should be shunted with a resistor. Write our Engineering Department for advice, giving full antenna detail when writing.

At times the arc gap at the base of the tower is set too close or has accumulated dirt. This causes an arc to ground under high modulation.

A crack in the tower base insulator is very unlikely but it should be inspected and keeping the base insulator clean is necessary. A low resistance path at this point is highly undesirable.

Look at the tower chokes. Though they are husky, they are in a vulnerable position for lightning. You might find a charred point that is causing the trouble.

- > Shunt fed towers or those with no base insulator are usually more sensitive to static bursts than series fed towers. The best method is to try and make the feed line to the tower equal the impedance of the transmission line. Talk to your consultant about this.

One side of the tower lighting circuit shorted to the tower itself, either permanently or intermittently, can cause trouble even though the lights may function perfectly.

13. OTHER OUTAGES. If the transmitter is the offender, such as acting improperly on a dummy antenna, the process of elimination by starting at the first and following through is preferred, unless of course the cause is actually known. The following may be helpful:

(FALL OUT) The transmitter turns off at high modulation. Possibly the overload relay is set too sensitive. The transmitter may not be properly neutralized where neutralization is required.

(HARD TO MODULATE) Cause can be either improper impedance match between transmitter and the transmission line or low grid drive to the final power amplifier. Consult the instruction book for correct grid drive. The correct match of the transmitter to load is covered in the instruction book. Usually an antenna current meter that does not move up freely with modulation indicates a mismatch between the transmitter and its loading equipment.

(BAD REGULATION) The size of the primary lines between the meter box and the transmitter is extremely important. If they are too small, bad regulation will exist. In some instances the power line has bad regulation too. This

Tube checking. Check tubes at least monthly and it is just as easy to do it each week during the periodic maintenance program. Certain tubes will become gaseous if left on the spare tube shelf too long. This type of tube should be rotated into the transmitter to prevent an emergency change to the spare tube, only to find it blowing out because of a gaseous condition.

Oiling. If the transmitter has blowers, oil them as required, but do not over-oil. Some types of turntables require oiling the motors.

Relay contacts. Burnish the contacts with an approved burnishing tool. This should be done about every six to eight weeks.

Other preventive ideas. Clean mixing attenuators if they are not the sealed type, with carbon tetrachloride, about once monthly. Every station should have a small suction type cleaner. Even your wife's Hoover with the suction attachments will do an excellent job of pulling dust from the inside of the hard to get corners of a transmitter. Take a leaf from the Navy book which says everything must at all times be sparkling clean or what is know as ship-shape.

17. ADEQUATE TEST EQUIPMENT. To have a maintenance program, certain capital equipment is necessary. Do not be ashamed to tell your Manager about this because he will recognize that proper maintenance is saving money and not spending money. As a minimum, you should have this equipment:

Dummy antenna (frequently supplied in Gates transmitters).

Proof of performance equipment, which includes an audio oscillator, distortion meter, gain set, and RF pickup coil or rectifier, known as the Gates SA131 proof of performance package.

A good grade of voltohmmeter.

A spare antenna current meter.

An inexpensive oscilloscope.

All of the above will cost less than \$1000.00 and will pay for itself many times through the years.

18. THE CHIEF ENGINEER. He has the job of keeping everybody happy - listeners, Manager, and stockholders. When trouble comes, he is under pressure. He will do his best to correct the problem as fast as he can. It is well to remember that electronic equipment has many circuits and many avenues of travel. Where problems are known, the solution is usually quick. Where the problem must be found, the solution will take time. It is well to remember that if equipment did not need maintenance, it would not need a Chief Engineer. The greatest service he renders is the insistence on a regular preventive maintenance program, which he knows will prevent most problems. If the unusual problem does arrive, causing an outage, everyone in the broadcasting should be understanding and tolerant as the problem can be solved quickest by not breathing over the Chief Engineer's shoulder.

19. GATES ASSISTANCE TO HELP. Gates sincerely believes that the best type of assistance it can render to the technical personnel in the radio broadcasting industry is in providing full cooperation, day or night, in solving any problem no matter how small. Gates technical people recognize that sometimes the biggest problem is solved in the most simple manner. This is part of electronics and never is fun poked at a simple solution because this is the happiest kind. It is only by asking questions of any calibre, simple or complex, of Gates people and mutually working together that the finest degree of broadcast programming is possible in your broadcasting station and the industry.

Service avenues. Unless the problem is of an emergency nature, Gates suggests that you write to the Gates Service Department about problems that you are experiencing. If you have a problem that can not wait, call the Gates Service Department during daylight hours at Area Code 217, 222-8202. Gates daylight hours are from 8 A.M. to 5 P.M., Monday thru Friday, Central Standard Time or Central Daylight Time, depending upon the period of the year. Gates nighttime service can be obtained by calling Area Code 217, 222-8202.

GATES RADIO COMPANY
Subsidiary of Harris-Intertype Corporation
Quincy, Illinois, U.S.A.

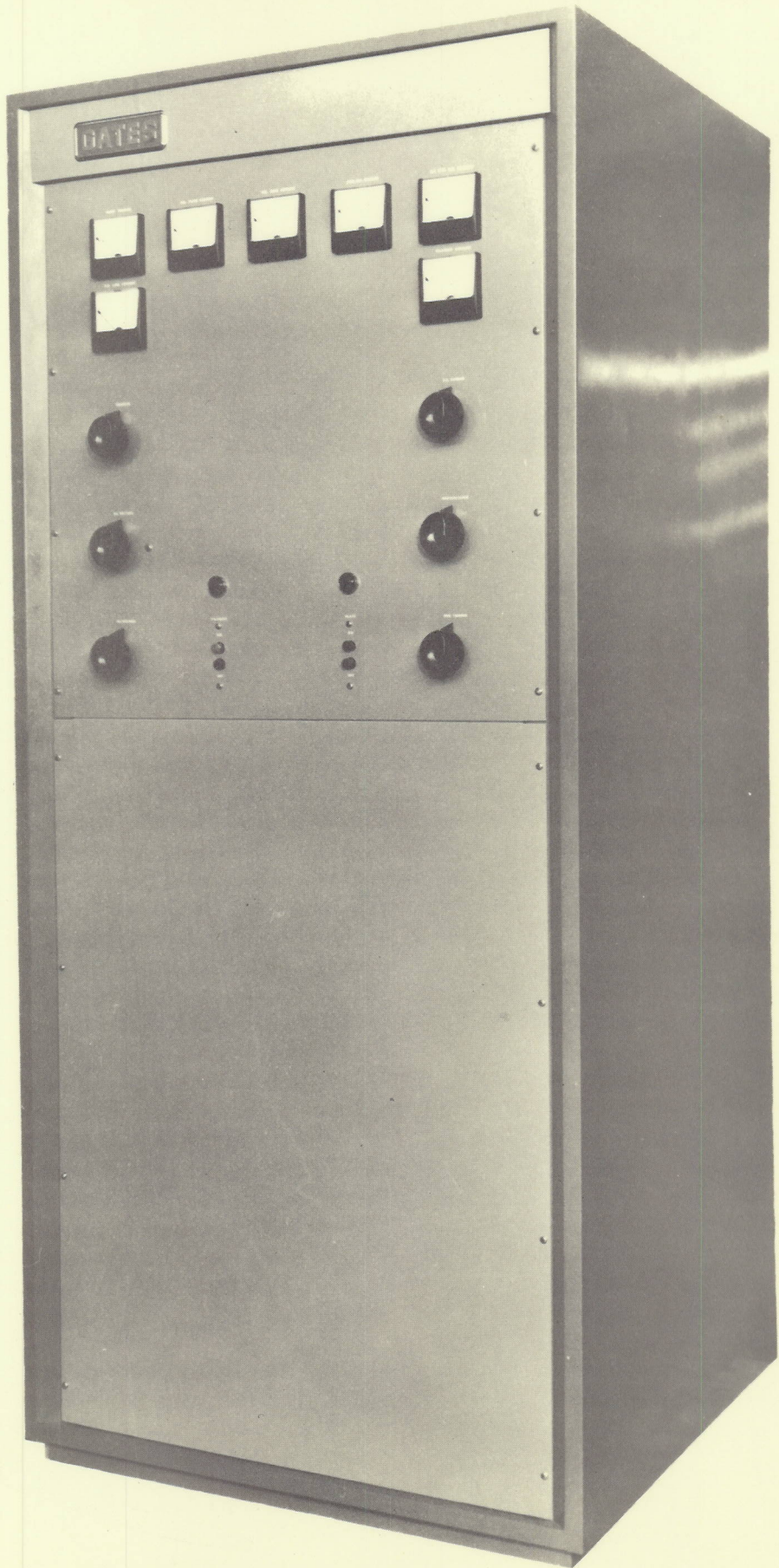

800 0553 001

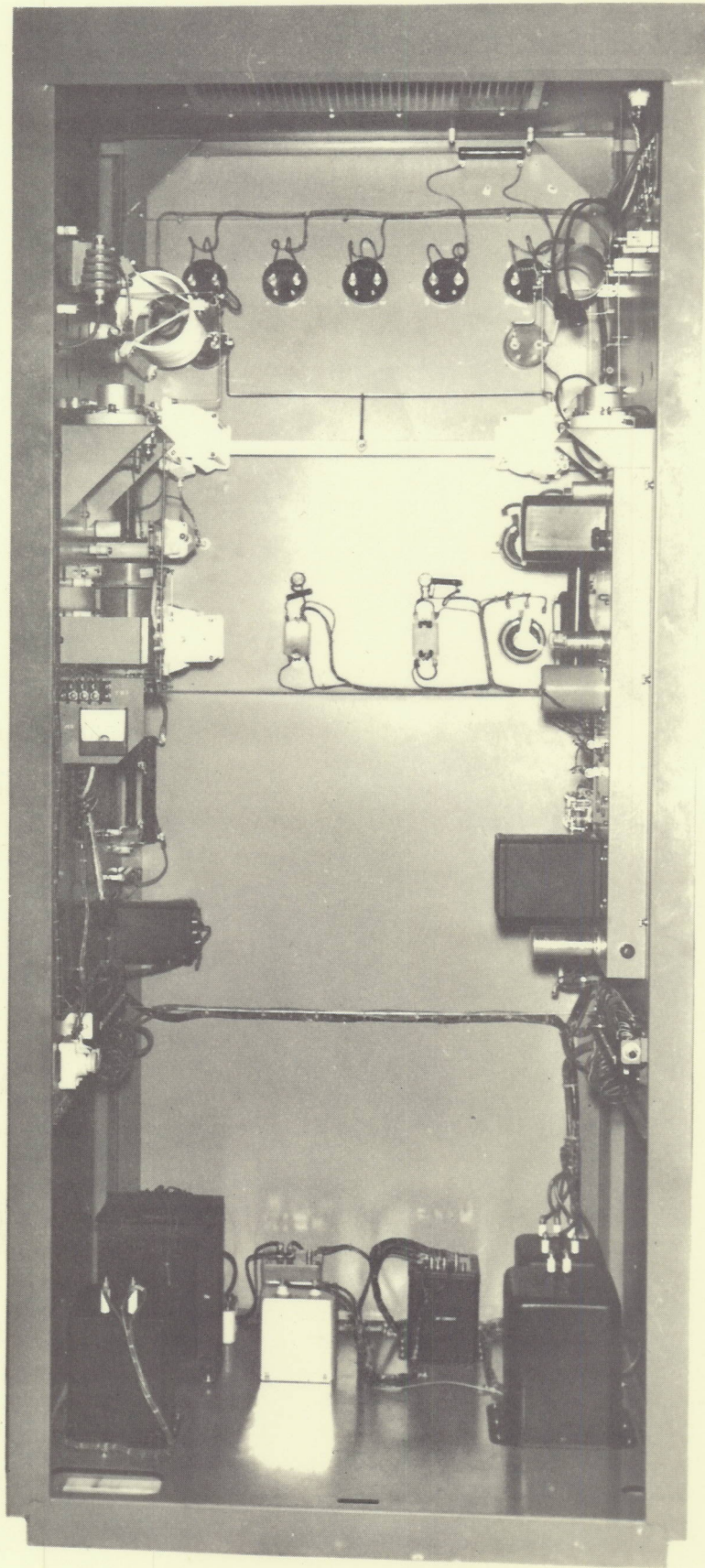

800 0627 001

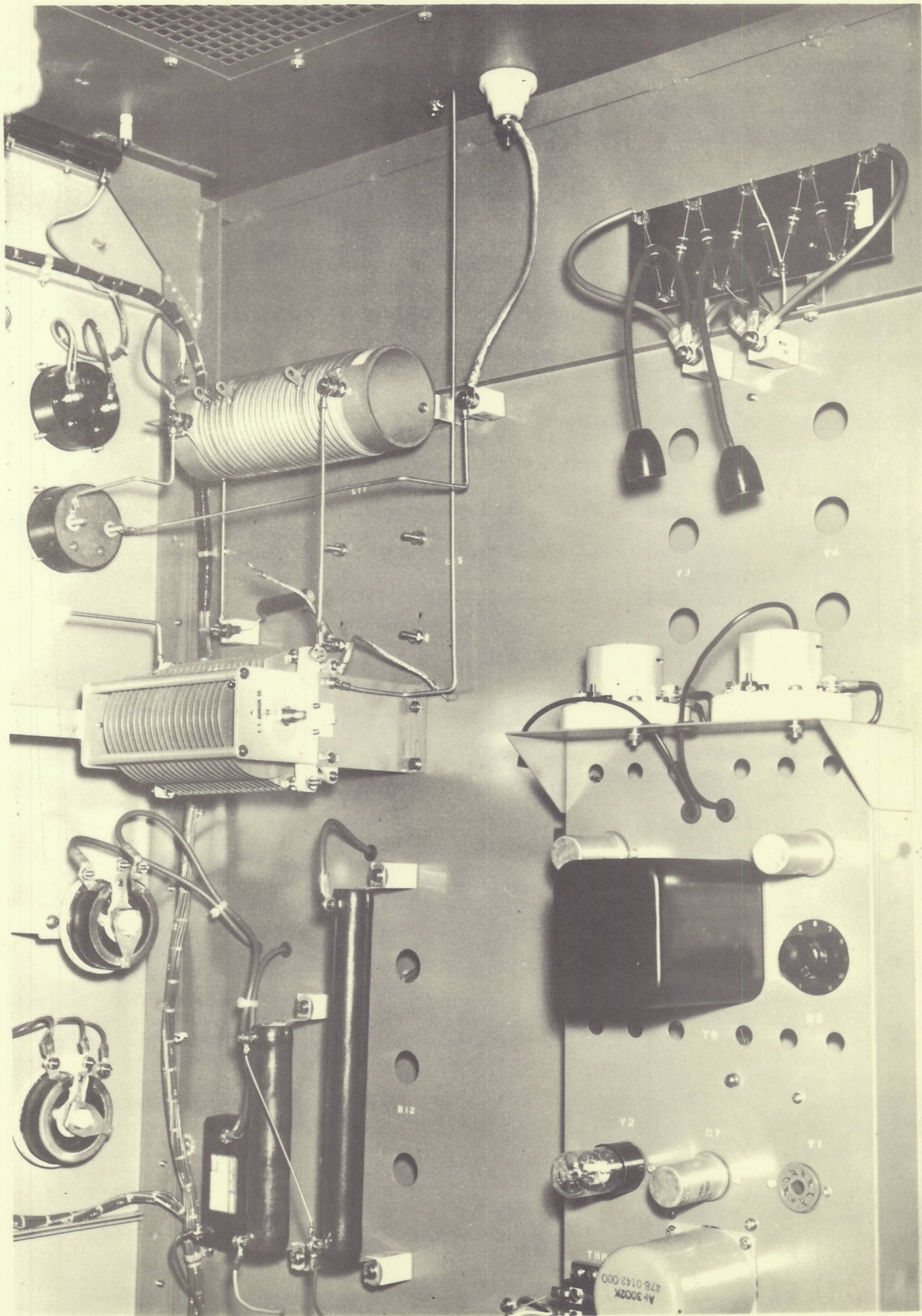

800 0627 003

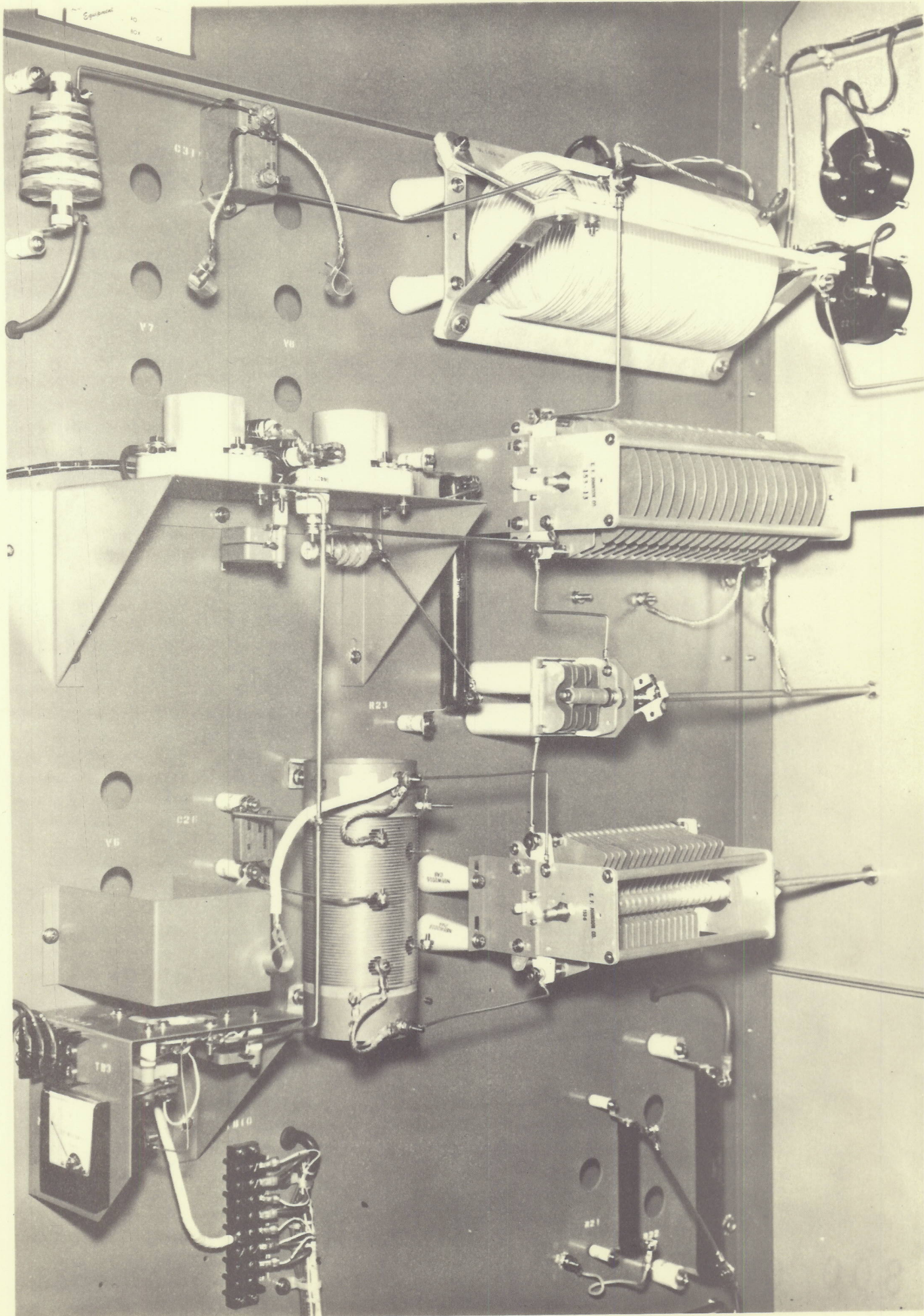

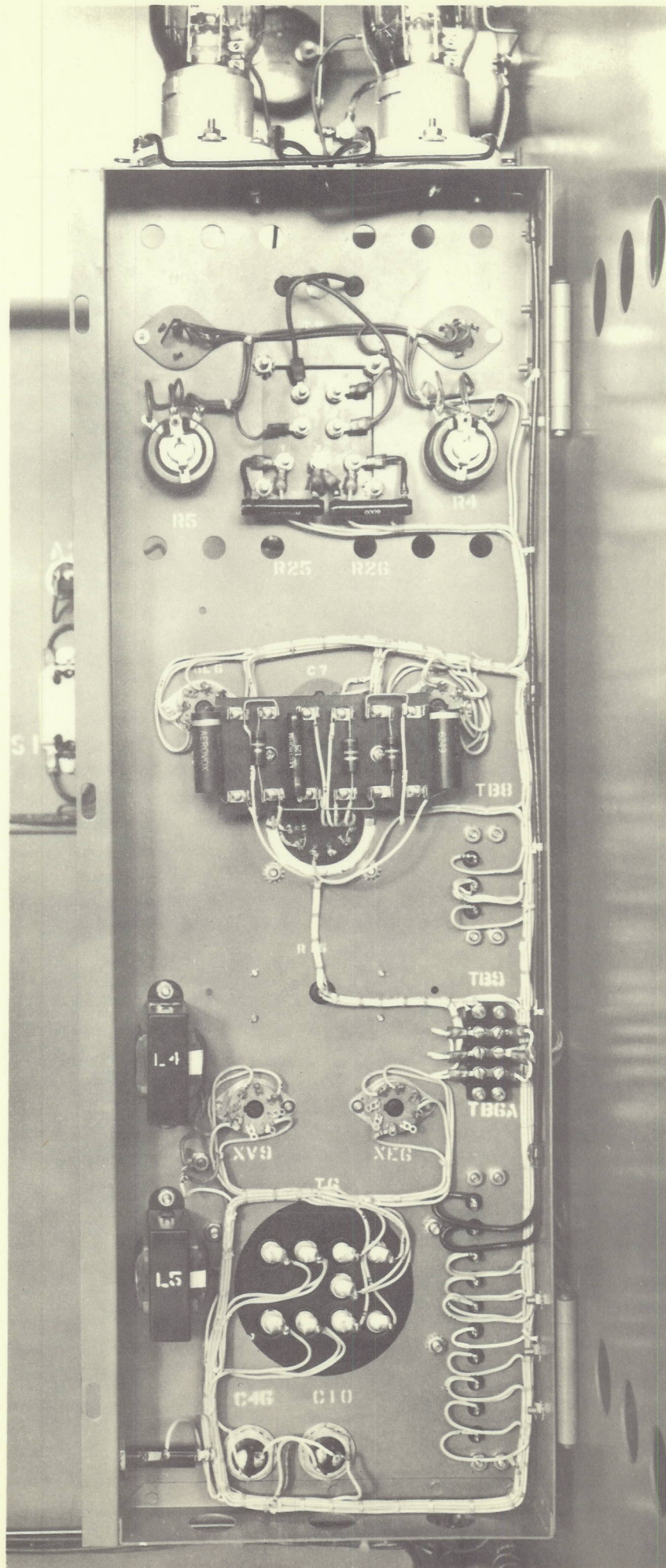

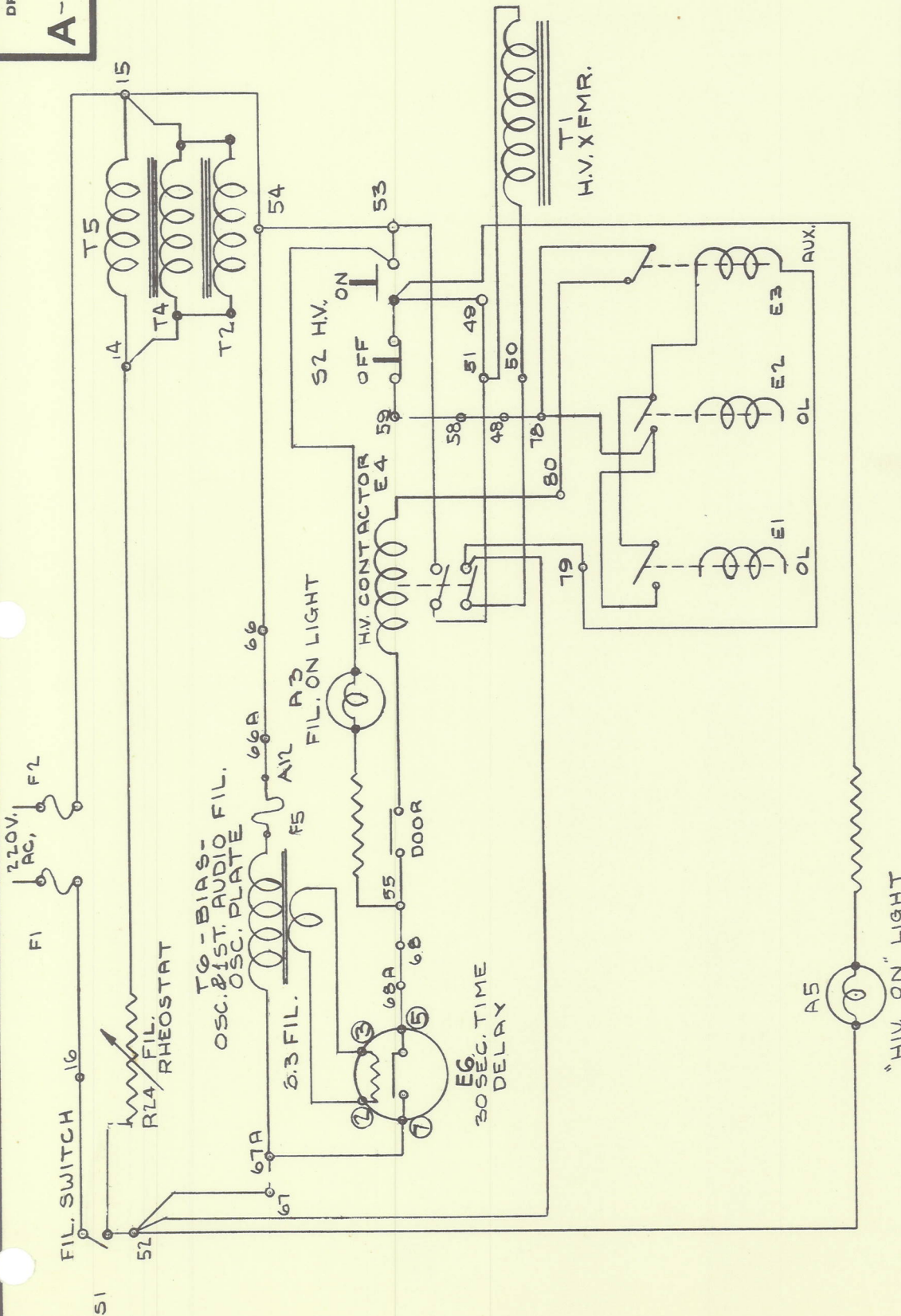

GATES RADIO COMPANY

QUINCY, ILLINOIS

DETAIL CONTROL CIRCUIT

750 GY

1	ECN # 1508 ADDED FUSE F 5-A 12 R 10-49
2	ECN # 5170 RGR 9-25-53
3	ECN-5567 3-4-54

MATERIAL SCALE

DR. BY HGH DATE 4-13-48

CH. BY AP ENG. L.B.P.

BC-250GY FREQ/LOAD DETERMINED COMPONENTS					
FREQ.	813 C41 TYPE F2L	C33 TYPE G1	810 C35 TYPE G1		
			250	70	50
			1600	NONE	0002
↓	↓	↓	↓	↓	↓
1300				003	003
↓				↓	↓
1250		0003	002		
↓		↓	↓		
1150		0004	003		004
↓		↓	↓		↓
860		0005		004	005
↓	↓	↓		↓	↓
780	0002				
↓	↓				
700					
↓					
690		0006	004	005	006
↓		↓	↓	↓	↓
650	↓				
↓	↓				
620	0004				
↓	↓				
600		0007	005	006	007
↓		↓	↓	↓	↓
550		0009	006	007	.01
LINE CURRENT METER M1			0-1.5A	0-3A	0-3A
813-810 COUPLING CONDENSER (C27)					
1600 - 750 KC			0001 Type H 2500 WV		
750 - 550 KC			0005 Type H 2500 WV*		
NOTE: Higher capacities may be obtained by parallel connection of two condensers.					
*Alternate Adjustment: .0001 mfd. at C27 and increase 813 grid tap on L7. Use whichever gives satisfactory P.A. drive with lowest 813 plate current.					

BC-250GY FREQ/LOAD CHART
FOR USE w/M5422 OSC.

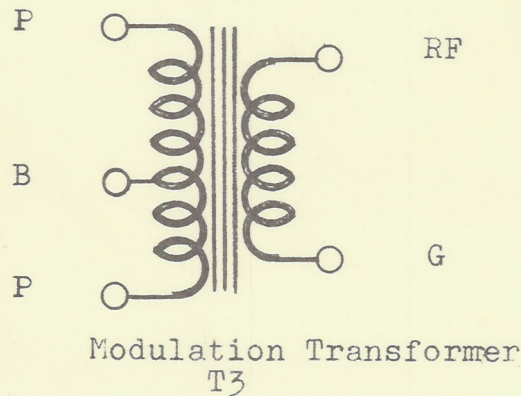
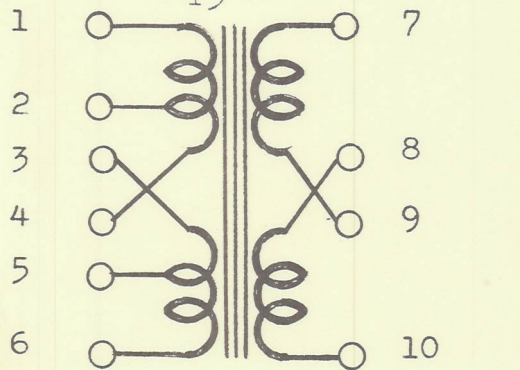
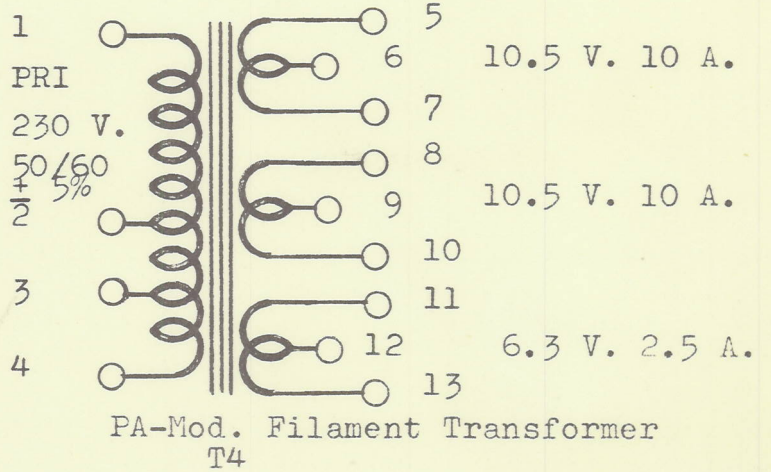
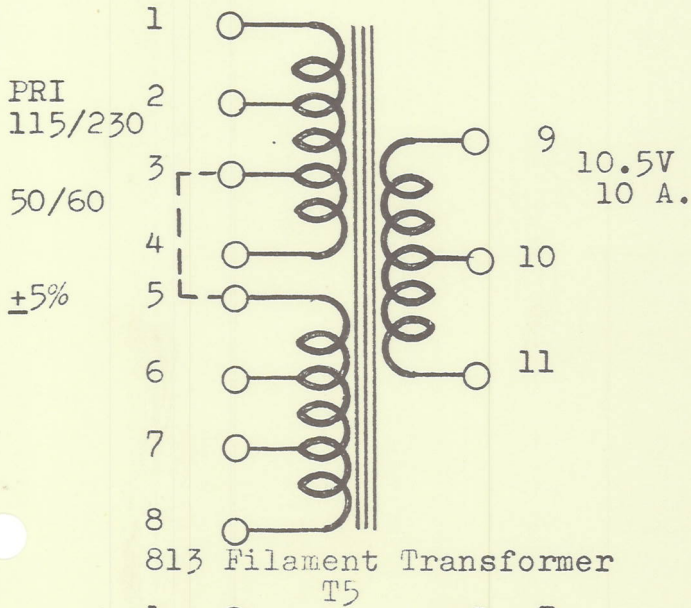
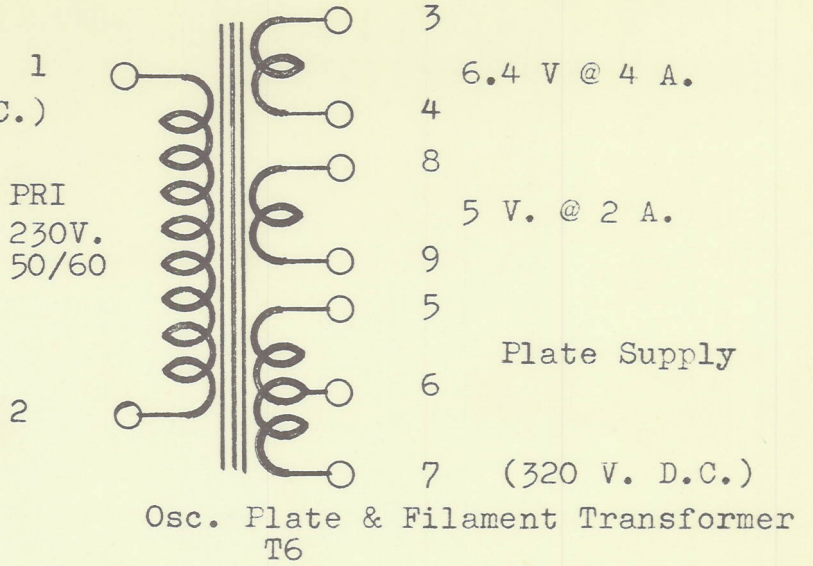
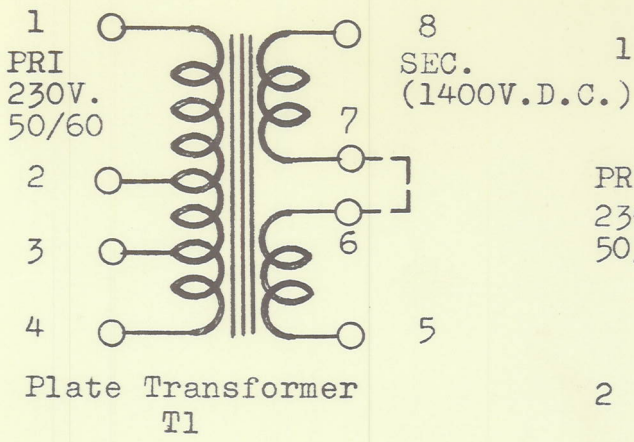

500 ohm 1 & 6
200 ohm 2 & 5
50 ohm 2 & 4

Join
3 to 4
3 to 4
2 to 3 &
4 to 5

Audio Input Transformer T8

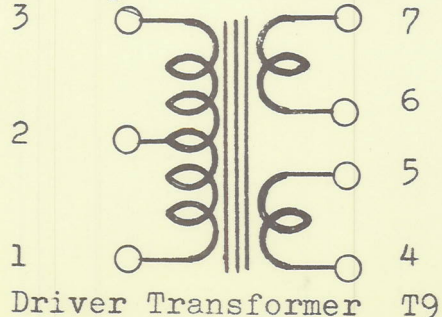
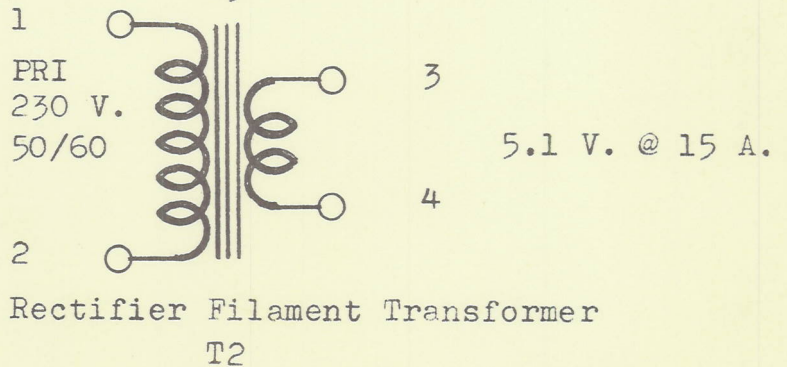

TRANSFORMER CONNECTIONS
BC-250GY TRANSMITTER-M3760C

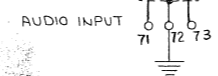
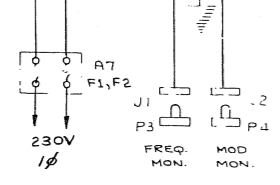
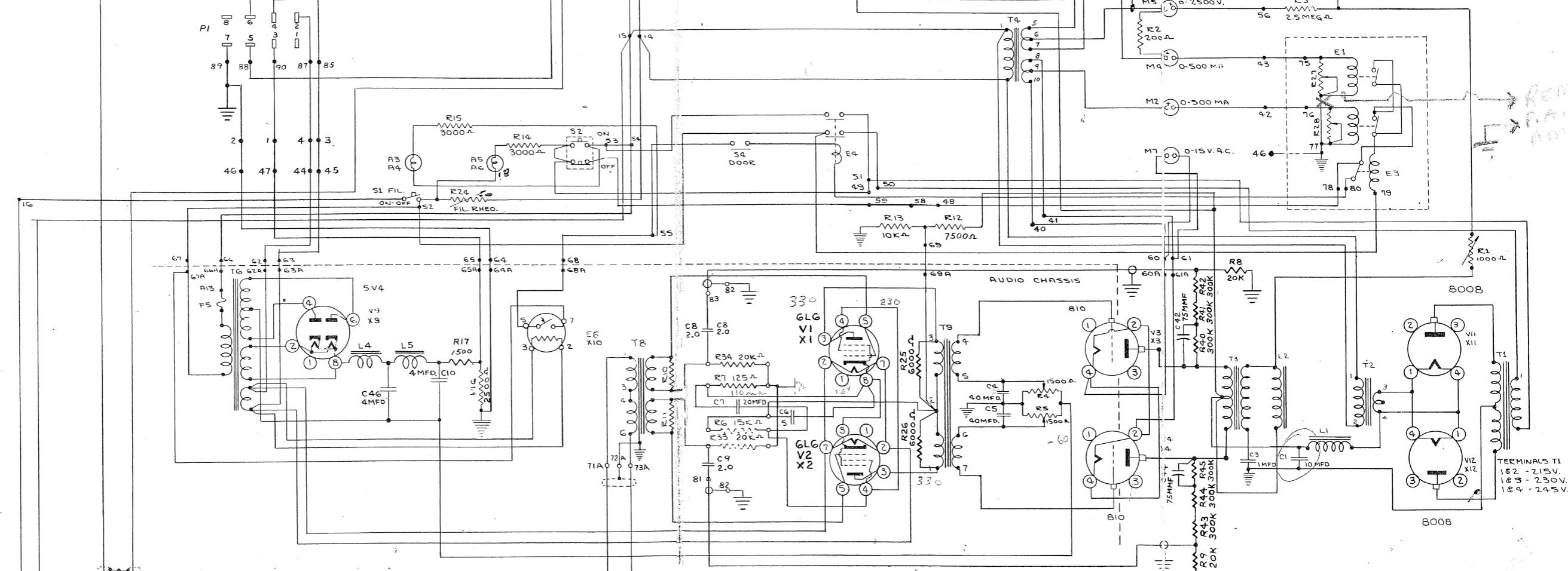
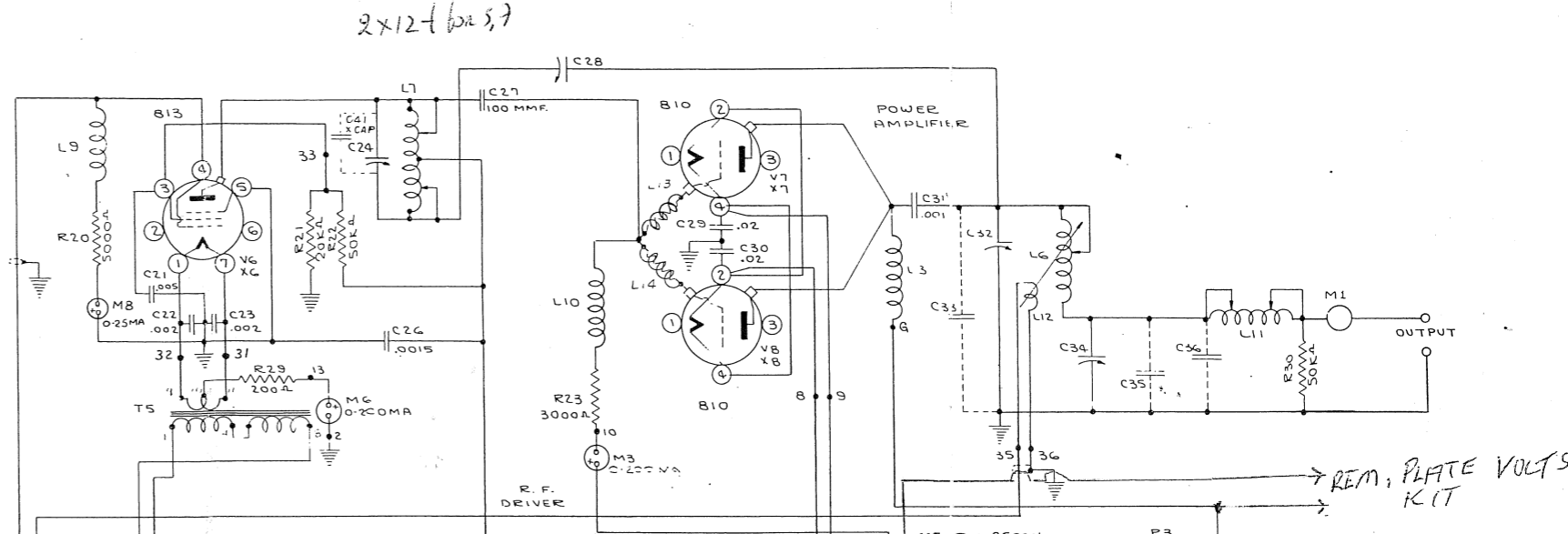
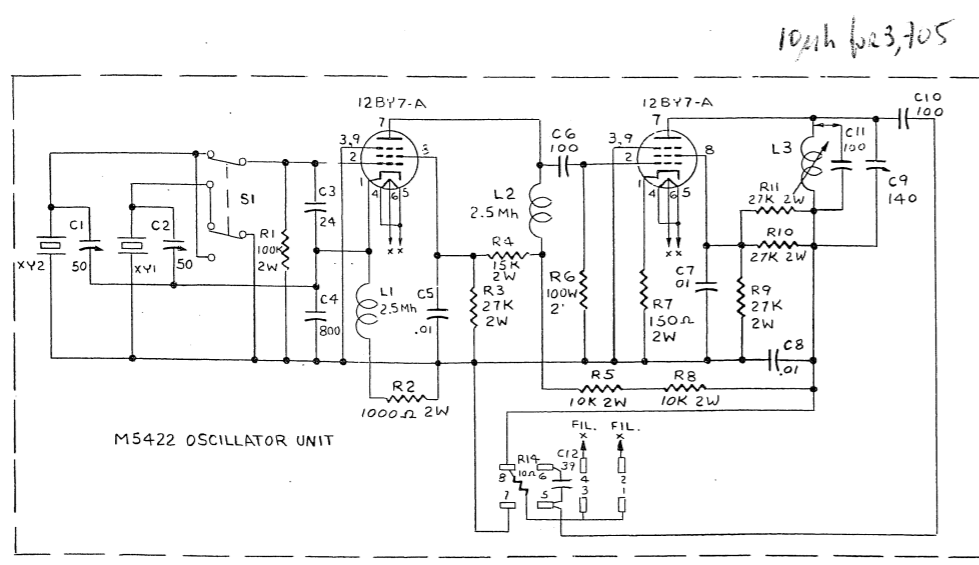

TERMINAL NUMBERS

TB1	1-20 INC.	R.F. PANEL
TB3	31-33 INC.	6B13 RF DRIVER
TB4	35 & 36	MOD. MON. PICKUP
TB5	40-59 INC.	AUDIO PANEL
TB6	60-69 INC.	AUDIO PANEL
TB6A	60A-69A INC.	AUDIO CHASSIS OVERLOAD RELAYS
TB7	75-80 INC.	AUDIO CHASSIS OVERLOAD RELAYS
TB8	11-13 INC.	AUDIO PANEL
TB8A	71A-73A INC.	AUDIO CHASSIS
TB9	81-83 INC.	FEEDBACK
TB10	84-91 INC.	OSCILLATOR

GATES RADIO COMPANY
 QUINCY, ILLINOIS

POINT TO POINT WIRING BC-250-GY
 MO-3760C

DR. BY: *J.A.* DATE: 9-5-63 DR. NO.
 CH. BY: *V.B.K.* ENG. *P.A., A.S.* 842-327-001