

Broadcast Equipment

Instructions

BTE-15A FM Exciter

ES-560631, ES-560632, ES-560633,

ES-560634, ES-560635, ES-560636

BTE-10AT FM Broadcast Transmitter

ES-560698 and ES-560698A

BTS-1B Stereo Generator,

Complete with Rack Mount and Power Supply

ES-560639

BTX-1B SCA Generator,

Complete with Rack Mount and Power Supply

ES-560640 and ES-560641

Communications Systems Division/Front and Cooper Streets/Camden, New Jersey, U.S.A. 08102

SAFETY PRECAUTIONS

This equipment is designed to fully safeguard all personnel from operating hazards. Labels on the equipment and caution notices in the instruction book clearly point out these potential hazards.

Any module or Printed Wiring Board may have hazardous voltages exposed, so caution must be exercised.

Follow the recommended procedures provided in the Instruction Book for care and maintenance of the equipment.

Always replace the protective covers after servicing the equipment.

WARRANTY ITEMS

Particular parts and/or equipment covered by warranty are specifically stated as such in the warranty or contract given to the customer at the time of sale. The warranty or contract also stipulates the conditions under which the warranty may be exercised.

To obtain a new replacement for such warranty items, contact your local RCA sales office and please supply Product Identification (including the Original Invoice Number, MI Number, Type Number, Model Number, and Serial Number) and Replacement Part Identification (including Stock Number and Description). Requests for warranty replacements may be unduly delayed if all this information is not supplied.

EQUIPMENT LOST OR DAMAGED IN TRANSIT

When delivering the equipment to you, the truck driver or carrier's agent will present a receipt for your signature. Do not sign it until you have (a) inspected the containers for visible signs of damage and (b) counted the containers and compared with the amount shown on the shipping papers. If a shortage or if evidence of damage is noted, insist that notation to that effect be made on the shipping papers before you sign them.

Further, after receiving the equipment, unpack it and inspect thoroughly for concealed damage. If concealed damage is discovered, immediately notify the carrier, confirming the notification in writing, and secure an inspection report. This item should be unpacked and inspected for damage **WITHIN 15 DAYS** after receipt. Report all shortages and damages to RCA, Communication Systems Division - Camden, New Jersey 08102.

RCA will file all claims for loss and damage on this equipment so long as the inspection report is obtained. Disposition of the damaged item will be furnished by RCA.

FIELD ENGINEERING SERVICE

RCA Field Engineering Service is available at current rates. Requests for field engineering service may be addressed to your RCA Broadcast Field Representative or the RCA Service Company, Incorporated - Broadcast Service Division - Camden, New Jersey 08102. Telephone 609-963-8000.

TECH ALERT

Emergency 24 hour telephone consultation service for technical problems is available. Call **TECH ALERT** at 609-963-8000 extension PC3434.

WARNING

VOLTAGES THAT ARE DANGEROUS TO LIFE ARE INVOLVED IN THE OPERATION OF THIS ELECTRONIC EQUIPMENT. OPERATING PERSONNEL MUST AT ALL TIMES OBSERVE ALL SAFETY REGULATIONS. DO NOT CHANGE TUBES OR MAKE ADJUSTMENTS INSIDE THE EQUIPMENT WITH VOLTAGES APPLIED. DANGEROUS CONDITIONS MAY EXIST IN CIRCUITS WITH POWER CONTROLS IN THE OFF POSITION DUE TO CHARGES RETAINED BY CAPACITORS, ETC. ALWAYS DISCHARGE AND GROUND CIRCUITS PRIOR TO TOUCHING THEM TO AVOID PERSONAL INJURY OR LOSS OF LIFE.

EMERGENCY FIRST AID INSTRUCTIONS

Personnel engaged in the installation, operation, or maintenance of this equipment or similar equipment are urged to become familiar with the following rules both in theory and practice. It is the duty of all operating personnel to be prepared to give adequate Emergency First Aid and thereby prevent avoidable loss of life.

RESCUE BREATHING



1. Find out if the person is breathing.

You must find out if the person has stopped breathing. If you think he is not breathing, place him flat on his back. Put your ear close to his mouth and look at his chest. If he is breathing, you can feel the air on your cheek. You can see his chest move up and down. If you do not feel the air or see the chest move, he is not breathing.

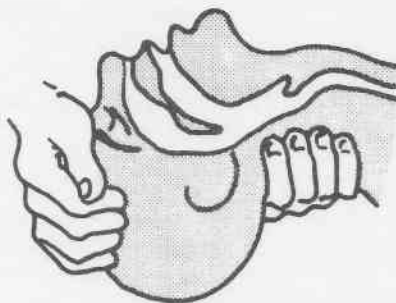

2. If he is not, open the airway by tilting his head backward.

Lift up his neck with one hand and push down on his forehead with the other. This opens the airway. Sometimes doing this will let the person breathe again by himself. If it does not, begin rescue breathing.



3. If he is still not breathing, begin rescue breathing:

Keep his head tilted backward. Pinch his nose shut. Put your mouth tightly over his mouth. Blow into his mouth once every five seconds. Do Not Stop Rescue Breathing Until Help Comes.

LOOSEN CLOTHING — KEEP WARM

Do this when the victim is breathing by himself or help is available. Keep him quiet as possible and from becoming chilled. Otherwise, treat him for shock.

BURNS

SKIN REDDENED: Apply ice cold water to burned area to prevent burn from going deeper into skin tissue. Cover area with clean sheet or cloth to keep away air. Consult a physician.

SKIN BLISTERED OR FLESH CHARRED: Apply ice cold water to burned area to prevent burn from going

deeper into skin tissue. Cover area with clean sheet or cloth to keep away air. Treat victim for shock and take to hospital.

EXTENSIVE BURN-SKIN BROKEN: Cover area with clean sheet or cloth to keep away air. Treat victim for shock and take to hospital.

LIST OF REVISED, ADDED OR DELETED PAGES

The following is a list of the pages in this Instruction Book that have been Revised, Added, or Deleted with their effective date of change:

- Front Cover - New
- Title Page - New
- I through III - New
- A - Added
- V through 154 - New

FIRST AID INSTRUCTIONS

RESCUE BREATHING



1. If the victim is not breathing, open the airway by tilting the head back and lifting the chin. If you cannot see the mouth, lift the jaw. If you still cannot see the mouth, use the head-tilt-chin-lift technique.

2. If the victim is not breathing, give rescue breathing. Breathe into the victim's mouth for 1 to 2 seconds. Watch for chest rise. Repeat every 5 to 6 seconds.

3. If the victim is not breathing and has no pulse, give rescue breathing and chest compressions. Give 15 compressions followed by 2 breaths. Repeat every 2 minutes.

1. If the victim is not breathing, open the airway by tilting the head back and lifting the chin. If you cannot see the mouth, lift the jaw. If you still cannot see the mouth, use the head-tilt-chin-lift technique.

2. If the victim is not breathing, give rescue breathing. Breathe into the victim's mouth for 1 to 2 seconds. Watch for chest rise. Repeat every 5 to 6 seconds.

3. If the victim is not breathing and has no pulse, give rescue breathing and chest compressions. Give 15 compressions followed by 2 breaths. Repeat every 2 minutes.

1. If the victim is not breathing, open the airway by tilting the head back and lifting the chin. If you cannot see the mouth, lift the jaw. If you still cannot see the mouth, use the head-tilt-chin-lift technique.

2. If the victim is not breathing, give rescue breathing. Breathe into the victim's mouth for 1 to 2 seconds. Watch for chest rise. Repeat every 5 to 6 seconds.

3. If the victim is not breathing and has no pulse, give rescue breathing and chest compressions. Give 15 compressions followed by 2 breaths. Repeat every 2 minutes.

INDEX

1. If the victim is not breathing, open the airway by tilting the head back and lifting the chin. If you cannot see the mouth, lift the jaw. If you still cannot see the mouth, use the head-tilt-chin-lift technique.

2. If the victim is not breathing, give rescue breathing. Breathe into the victim's mouth for 1 to 2 seconds. Watch for chest rise. Repeat every 5 to 6 seconds.

3. If the victim is not breathing and has no pulse, give rescue breathing and chest compressions. Give 15 compressions followed by 2 breaths. Repeat every 2 minutes.

TABLE OF CONTENTS

BTE-15A EXCITER

- TECHNICAL SUMMARY..... 1
 - Electrical Specifications..... 1
 - Mechanical Specifications..... 1
- BTE-15A FM EXCITER SYSTEM OPTIONS..... 2
- CRYSTAL UNITS..... 3
- TRANSISTOR AND IC COMPLEMENT..... 4
- RECOMMENDED TEST EQUIPMENT..... 4
- DESCRIPTION..... 5
 - BTE-15A Exciter System..... 5
 - FM Exciter..... 6
 - Modulated Oscillator..... 8
 - Radio Frequency Power Amplifier (RFA)..... 8
 - AFC Circuit..... 9
 - BTS-1B Stereo Generator..... 9
 - Stereo Carrier and Pilot..... 10
 - Audio Channels..... 10
 - Switching Modulator..... 10
 - Monaural Operation..... 12
 - Monaural Audio Module..... 12
 - BTX-1B SCA Subcarrier Generator..... 12
 - Modulated Oscillator..... 13
 - Muting Circuits..... 13
 - BTE-15A Main Frame..... 15
 - Off-Frequency Shutdown Circuit..... 15
 - Meter Amplifier..... 16
- INSTALLATION..... 16
 - Main Frame..... 16
 - Connections..... 16
 - FM Exciter..... 17
 - Stereo Generator..... 17
 - SCA Generator..... 17
- TUNING..... 17
 - BTE-15A RF Amplifier (RFA)..... 17
 - BTS-1B Stereo Generator..... 18
 - BTX-1B SCA Generator..... 19
 - Typical Panel Meter Readings (Table)..... 20
- PARTS ORDERING INFORMATION..... 24
 - Replacement Parts..... 24
 - Emergency Parts Service..... 24
- REPLACEMENT PARTS..... 25
- SUGGESTED EQUIPMENT SPARES..... 40

SUPPLEMENT I

BTE-10AT FM BROADCAST TRANSMITTER

- EQUIPMENT LIST..... 131
 - BTE-10AT FM Broadcast Transmitter, Cabinet Mounted Version, ES-560698..... 131
 - BTE-10AT FM Broadcast Transmitter, Rack Mounted Version, ES-560698A..... 131
- TECHNICAL SUMMARY..... 131
 - Electrical Specifications..... 131
 - Mechanical Specifications..... 131

SUPPLEMENT I (Continued)**BTE-10AT FM BROADCAST TRANSMITTER**

DESCRIPTION.....	132
General.....	132
INSTALLATION.....	133
OPERATION.....	134
REPLACEMENT PARTS.....	134

SUPPLEMENT II**BTS-1B STEREO GENERATOR**

EQUIPMENT LIST.....	137
BTS-1B (Rack Mounted) ES-560639.....	137
TECHNICAL SUMMARY.....	137
Electrical.....	137
Mechanical.....	137
DESCRIPTION.....	138
REPLACEMENT PARTS.....	140
SUGGESTED EQUIPMENT SPARES.....	140

SUPPLEMENT III**BTX-1B SCA GENERATOR****COMPLETE with RACK MOUNT and POWER SUPPLY**

EQUIPMENT LIST.....	
BTX-1B (Rack Mounted) ES-560640.....	147
BTX-1B (Rack Mounted) ES-560641.....	147
TECHNICAL SUMMARY.....	
Electrical.....	147
Mechanical.....	147
DESCRIPTION.....	148
REPLACEMENT PARTS.....	150
SUGGESTED EQUIPMENT SPARES.....	150

LIST OF ILLUSTRATIONS

Figure		Page
1	BTE-15A Exciter System	5
2	BTE-15A System, Block Diagram	6
3	FM Exciter, Simplified Block Diagram	7
4	BTS-1B Stereo Generator, Simplified Block Diagram	11
5	BTX-1B SCA Generator, Simplified Block Diagram	14
5a	Typical Waveforms, BTS-1B Stereo Generator	21
6	BTE-15A Exciter System, Front View	42
7	BTE-15A System, Module Extender	43
8	BTE-15A System, Module Extender Installed	43
9	BTE-15A System, Modules Removed	44
10	Main Frame, Rear View	45
11	Main Frame, Parts Location	46
12	Main Frame, Rectifier and Filter	47
13	Main Frame, Fuse Panel	47
14	Main Frame Metering Amplifier Board, Parts Location	48
15	Main Frame Metering Amplifier Board, Parts Location	49
16	Main Frame Metering Amplifier Board, Parts Overlay, Top	50
17	Main Frame Metering Amplifier Board, Parts Overlay, Bottom	51
18	Exciter, Top View	52
19	Exciter, Modulated Oscillator Board, Parts Location	53
20	Exciter, Modulated Oscillator Board, Parts Location	54
21	Exciter, AFC Board, Parts Location	55
22	Exciter, RF Amplifier, Parts Location, Top	56
23	Exciter, RF Amplifier, Parts Location, Bottom	57
24	Exciter, Modulated Oscillator Board, Parts Overlay, Top	58
25	Exciter, Modulated Oscillator Board, Parts Overlay, Bottom	59
26	Exciter, AFC Board, Parts Overlay, Top	60
27	Exciter, AFC Board, Parts Overlay, Bottom	61
28	Stereo Generator, Overall View	62
29	Stereo Generator Board, Parts Location	63
30	Stereo Generator Board, Parts Location	64
31	Stereo Generator Board, Parts Location	65
32	Stereo Generator Board, Parts Location	66
33	Stereo Generator Sub-Board, Parts Location	67
34	Stereo Generator Board, Parts Overlay, Top	68
35	Stereo Generator Board, Parts Overlay, Bottom	69
36	Stereo Generator Sub-Board, Parts Overlay, Top	70
37	Stereo Generator Sub-Board, Parts Overlay, Bottom	71
38	Monaural Audio Board, Parts Overlay, Top	72
39	Monaural Audio Board, Parts Overlay, Bottom	73
40	SCA Generator Overall View	74
41	SCA Generator Board, Parts Location, Ser. No. 1 through 999	75
42	SCA Generator Board, Parts Location, Ser. No. 1 through 999	76
42a	SCA Generator Board, Parts Location, Ser. No. 1000 and up	77
42b	SCA Generator Board, Parts Location, Ser. No. 1000 and up	78
43	SCA Generator Board, Parts Location, Ser. No. 1 through 999	79
43a	SCA Generator Board, Parts Location, Ser. No. 1000 and up	80
44	SCA Generator Board, Parts Location, Ser. No. 1 through 999	82
44a	SCA Generator Board, Parts Location, Ser. No. 1000 and up	83
45	SCA Generator Board, Parts Overlay, Bottom, Ser. No. 1 through 999	84
45a	SCA Generator Board, Parts Overlay, Ser. No. 1000 and up	85
46	SCA Option Select Board, Parts Overlay, Top	86
47	SCA Option Select Board, Parts Overlay, Bottom	86
48	BTS-1B Power Supply Board, Parts Overlay	87
49	BTX-1B Power Supply Board, Parts Overlay	87
-	Semiconductor Base Data	88
-	Integrated Circuit Schematics	90
50	BTE-15A Main Frame, Schematic Diagram	95
51	BTE-15A FM Exciter, Schematic Diagram	97
52	BTS-1B Stereo Generator, Schematic Diagram	99
53	Monaural Audio Module, Schematic Diagram	101
54	BTX-1B SCA Generator, Schematic Diagram, Ser. No. 1 through 999	103
54a	BTX-1B SCA Generator, Schematic Diagram, Ser. No. 1000 and up	105
55	T101 Connection	107
56	Test Fixture	108
57	BTX-1B Low-Pass Filter Installation	109
58	Main Frame, Wiring Diagram	111
59	Main Frame Door Assembly, Wiring Diagram	113
60	Exciter Assembly, Wiring Diagram	115
61	Exciter, Modulated Oscillator and AFC Assembly, Wiring Diagram	117
62	Exciter, RF Amplifier Assembly, Wiring Diagram	119
63	Stereo Generator, Wiring Diagram	121
64	Stereo Generator Filter and Transformer Assembly, Wiring Diagram	123

LIST OF ILLUSTRATIONS (Continued)

Figure		Page
65	Monaural Audio Module, Wiring Diagram.....	125
66	SCA Generator, Wiring Diagram	127
67	BTE-10AT FM Transmitter ES-560698.....	132
68	Connector Cap Assembly Details.....	133
69	BTE-10AT FM Transmitter, Rear View.....	134
70	BTS-1B Stereo Generator ES-560639.....	138
71	BTS-1B Stereo Generator, Rear View.....	139
72	BTS-1B Stereo Generator Main Frame, Schematic Diagram.....	141
73	BTS-1B Stereo Generator Main Frame, Wiring Diagram.....	143
74	BTX-1B SCA Generator ES-560641.....	148
75	BTX-1B SCA Generator, Rear View.....	149
76	SCA Generator Main Frame, Schematic Diagram	151
77	SCA Generator Main Frame, Wiring Diagram.....	153

TECHNICAL SUMMARY

ELECTRICAL SPECIFICATIONS

Type of Emission	F3 and F9
Frequency Range	88 to 108 MHz
Power Output	15 watts nominal, adjustable
Output Impedance	50 ohms
Modulation Capability	±125 KHz min.
Carrier Frequency Stability	±1000 Hz max.
Audio Input Impedance	600 / 150 ohms, resistive ¹
Audio Frequency Response (30-15,000 Hz)	±1 dB max ³
Audio Input Level (100% Modulation)	+ 10 ±2 dBm ²
Harmonic Distortion (50-15,000 Hz)	0.5% or less ⁴
FM Noise Level (referred to 100% FM Modulation)	-68 dB max.
AM Noise Level (referred to carrier voltage)	-60 dB max.
SCA Subcarrier Input Level (100% modulation)	-15 to +10 dBm, adjustable
SCA Subcarrier Input Impedance	600 / 150 ohms, bal.
Main Channel to Sub-Channel Crosstalk	-50 dB ⁵
Sub-Channel to Main Channel Crosstalk	-60 dB ⁶
Power Line Requirements	117V / 208 / 240V ±5%, 50 / 60 Hz
Slow Voltage Variations	±5%
Power Consumption BTE-15A Exciter, including BTS-1B Stereo Generator and BTX-1B SCA Generator	80 watts

MECHANICAL SPECIFICATIONS

	Net	Shipping
Height	10-1/2"(26.7 cm)	19"(483 cm)
Width	19"(48.3 cm)	24-1/4"(56.5 cm)
Depth	12-5/8"(32.1 cm)	17-1/2"(44.5 cm)
Weight	40lb.(18.1 kg)	59lb.(26.8 kg)
Altitude (Max.)		7500 ft.
Temperature Range		-20 to +50°C

¹ Audio pre-emphasis 75 microseconds (50 microseconds if desired).

² Level measured at input jack with 400 Hz tone applied.

³ Audio frequency response referred to 75 (or 50) microsecond pre-emphasis curve.

⁴ Distortion includes all harmonics up to 30 KHz and is measured following a standard 75 (or 50) microsecond de-emphasis network.

⁵ Relative to ±7.5 KHz deviation of the subcarrier by a 400 Hz tone, main channel modulated 70% by 30 to 15000 Hz tones and 30% by subcarrier, using narrowband detector.

⁶ Relative to ±75 KHz deviation of the main carrier by a 400 Hz tone, subcarrier modulated ±7.5 KHz by 30 to 6000 Hz tones, main carrier modulated 30% by subcarrier, using narrowband detector.

BTE-15A FM EXCITER SYSTEM OPTIONS

The BTE-15A FM Exciter System is available in several forms.

- | | |
|---|-------------|
| 1. Mono System, ES-560631, includes | |
| (A) 1 Main frame | MI-560710 |
| (B) 1 BTE-15A r-f exciter module | MI-560712 |
| (C) 1 Monaural audio module (replaces BTS-1B Stereo generator) | MI-560716 |
| (D) 2 Blank panels (used in place of SCA generators) | MI-560715 |
| (E) 1 Crystal, with oven (operate crystal for BTE-15A exciter module) | MI-560717-* |
| (F) 1 Module extender | MI-560719 |
| 2. Mono and 1 SCA System, ES-560632, includes | |
| (A) 1 Main frame | MI-560710 |
| (B) 1 BTE-15A r-f exciter module | MI-560712 |
| (C) 1 Monaural audio module (replaces BTS-1B Stereo generator) | MI-560716 |
| (D) 1 BTX-1B SCA generator | MI-560714-* |
| (E) 1 Blank panel (used in place of second SCA generator) | MI-560715 |
| (F) 1 Crystal, with oven (operate crystal for BTE-15A exciter module) | MI-560717-* |
| (G) 1 Module extender | MI-560719 |
| (H) 1 5 kHz low pass filter (installed) | MI-560221 |
| 3. Mono and 2 SCA System, ES-560633, includes | |
| (A) 1 Main frame | MI-560710 |
| (B) 1 BTE-15A r-f exciter module | MI-560712 |
| (C) 1 Monaural audio module (replaces BTS-1B Stereo generator) | MI-560716 |
| (D) 2 BTX-1B SCA generator | MI-560714-* |
| (E) 1 Crystal, with oven (operate crystal for BTE-15A exciter module) | MI-560717-* |
| (F) 1 Module extender | MI-560719 |
| (G) 2 5 kHz low pass filter (installed) | MI-560221 |
| 4. Stereo System, ES-560634, includes | |
| (A) 1 Main frame | MI-560710 |
| (B) 1 BTE-15A r-f exciter module | MI-560712 |
| (C) 1 BTS-1B Stereo generator | MI-560713 |
| (D) 2 Blank panels (used in place of SCA generators) | MI-560715 |
| (E) 1 Crystal, with oven (operate crystal for BTE-15A exciter module) | MI-560717-* |
| (F) 1 Module extender | MI-560719 |
| 5. Stereo and 1 SCA System, ES-560635, includes | |
| (A) 1 Main frame | MI-560710 |
| (B) 1 BTE-15A r-f exciter module | MI-560712 |
| (C) 1 BTS-1B Stereo generator | MI-560713 |
| (D) 1 BTX-1B SCA generator | MI-560714-* |
| (E) 1 Blank panel (used in place of second SCA generator) | MI-560715 |
| (F) 1 Crystal, with oven (operate crystal for BTE-15A exciter module) | MI-560717-* |
| (G) 1 Module extender | MI-560719 |
| (H) 1 5 kHz low pass filter (installed) | MI-560221 |
| 6. Stereo and 2 SCA System, ES-560636, includes | |
| (A) 1 Main frame | MI-560710 |
| (B) 1 BTE-15A r-f exciter module | MI-560712 |
| (C) 1 BTS-1B Stereo generator | MI-560713 |
| (D) 2 BTX-1B SCA generator | MI-560714-* |
| (E) 1 Crystal, with oven (operate crystal for BTE-15A exciter module) | MI-560717-* |
| (F) 1 Module extender | MI-560719 |
| (G) 2 5 kHz low pass filter (installed) | MI-560221 |

A 41 kHz SCA can not be used simultaneously with stereo.

In addition, the following subsystems are available for use with existing FM exciters:

- | | |
|---|-------------|
| 1. BTS-1B Stereo Generator, ES-560639, includes | |
| (A) 1 Main frame (mounts stereo generator only) | MI-560711 |
| (B) 1 BTS-1B Stereo generator | MI-560713 |
| (C) 1 Module extender | MI-560719 |
| 2. BTX-1B SCA Generator (One) ES-560640, includes | |
| (A) 1 Main frame (mounts 1 or 2 SCA generators only) | MI-560720 |
| (B) 1 BTX-1B SCA generator | MI-560714-* |
| (C) 1 Blank panel (used in place of second SCA generator) | MI-560715 |
| (D) 1 Module extender | MI-560719 |
| (E) 1 5 kHz low pass filter (installed) | MI-560221 |
| 3. BTX-1B SCA Generator (Two) ES-560641, includes | |
| (A) 1 Main frame (mounts 1 or 2 SCA generators only) | MI-560720 |
| (B) 2 BTX-1B SCA generators | MI-560714-* |
| (C) 1 Module extender | MI-560719 |
| (D) 2 5 kHz low pass filter (installed) | MI-560221 |

The following optional items are available for use with BTE-15A Exciter Systems:

- | | |
|---|-----------|
| 1. Recommended Spare RF Transistors | MI-560718 |
| 2. A set of Connector Plugs for the BTE-15A Exciter | MI-560734 |

*MI item number, depending on Frequency, must be added.

1 = 609 - ~~338~~ 4506 = for MI # NUMBERS
 338 - 3576 - RAY POTTS

CRYSTAL UNITS

MI Number*	Carrier Freq. MHz	Crystal Freq. KHz	MI Number*	Carrier Freq. MHz	Crystal Freq. KHz
560717-1	88.1	86.0351	560717-51	98.1	95.8008
560717-2	88.3	86.2305	560717-52	98.3	95.9961
560717-3	88.5	86.4258	560717-53	98.5	96.1914
560717-4	88.7	86.6211	560717-54	98.7	96.3867
560717-5	88.9	86.8164	560717-55	98.9	96.5820
560717-6	89.1	87.0117	560717-56	99.1	96.7773
560717-7	89.3	87.2070	560717-57	99.3	96.9727
560717-8	89.5	87.4023	560717-58	99.5	97.1680
560717-9	89.7	87.5977	560717-59	99.7	97.3633
560717-10	89.9	87.7930	560717-60	99.9	97.5586
560717-11	90.1	87.9883	560717-61	100.1	97.7539
560717-12	90.3	88.1836	560717-62	100.3	97.9492
560717-13	90.5	88.3789	560717-63	100.5	98.1445
560717-14	90.7	88.5742	560717-64	100.7	98.3398
560717-15	90.9	88.7695	560717-65	100.9	98.5352
560717-16	91.1	88.9648	560717-66	101.1	98.7305
560717-17	91.3	89.1602	560717-67	101.3	98.9258
560717-18	91.5	89.3555	560717-68	101.5	99.1211
560717-19	91.7	89.5508	560717-69	101.7	99.3164
560717-20	91.9	89.7461	560717-70	101.9	99.5117
560717-21	92.1	89.9414	560717-71	102.1	99.7070
560717-22	92.3	90.1367	560717-72	102.3	99.9023
560717-23	92.5	90.3320	560717-73	102.5	100.0977
560717-24	92.7	90.5273	560717-74	102.7	100.2930
560717-25	92.9	90.7227	560717-75	102.9	100.4883
560717-26	93.1	90.9180	560717-76	103.1	100.6836
560717-27	93.3	91.1133	560717-77	103.3	100.8789
560717-28	93.5	91.3086	560717-78	103.5	101.0742
560717-29	93.7	91.5039	560717-79	103.7	101.2695
560717-30	93.9	91.6992	560717-80	103.9	101.4648
560717-31	94.1	91.8945	560717-81	104.1	101.6602
560717-32	94.3	92.0898	560717-82	104.3	101.8555
560717-33	94.5	92.2852	560717-83	104.5	102.0508
560717-34	94.7	92.4805	560717-84	104.7	102.2461
560717-35	94.9	92.6758	560717-85	104.9	102.4414
560717-36	95.1	92.8711	560717-86	105.1	102.6367
560717-37	95.3	93.0664	560717-87	105.3	102.8320
560717-38	95.5	93.2617	560717-88	105.5	103.0273
560717-39	95.7	93.4570	560717-89	105.7	103.2227
560717-40	95.9	93.6523	560717-90	105.9	103.4180
560717-41	96.1	93.8477	560717-91	106.1	103.6133
560717-42	96.3	94.0430	560717-92	106.3	103.8086
560717-43	96.5	94.2383	560717-93	106.5	104.0039
560717-44	96.7	94.4336	560717-94	106.7	104.1992
560717-45	96.9	94.6289	560717-95	106.9	104.3945
560717-46	97.1	94.8242	560717-96	107.1	104.5898
560717-47	97.3	95.0195	560717-97	107.3	104.7852
560717-48	97.5	95.2148	560717-98	107.5	104.9805
560717-49	97.7	95.4102	560717-99	107.7	105.1758
560717-50	97.9	95.6055	560717-100	107.9	105.3711

16500

*Each MI consists of one crystal oven and one crystal.

THE CRYSTAL FREQUENCY IS COMPUTED AS FOLLOWS:

$$F_{\text{crystal}} = \frac{F_{\text{carrier}}}{1024}$$

 560717-A
 A for oven only
 X for crystal
 5-60717-X

TRANSISTOR AND IC COMPLEMENT

BTE-15A FM EXCITER		
Q1	Modulated Oscillator	2N4427
Q2	Buffer	2N4427
Q3	RF Amplifier	2N3866
Q4	RF Amplifier	2N4440
Q5	RF Amplifier	2N5102
Q6	Logic Changer	2N3640
Q7	Logic Changer	2N4037
Q8	Crystal Oven Control	2N3054
IC1	Divider	MC1027P
IC2	Divider	MC1013P
IC3	Divider	MC1013P
IC4	Divider	MC9802P
IC5	Divider	MC890P
IC6	Divider	MC890P
IC7	Divider	MC890P
IC8	Divider	MC890P
IC9	Divider	MC890P
IC10	AFC Reference Oscillator	CA3028
IC11	Divider	MC890P
IC12	Divider	MC890P
IC13	Phase Comparator	MC825P
IC14	Inverter-Amplifier	CA-3018
BTE-15A MAIN FRAME		
Q101	1/2 Darlington Regulator	2N3055
Q102	1/2 Darlington Regulator	2N5293
Q103	Emitter-Follower Regulator	2N5293
Q104	Emitter-Follower Regulator	2N3740
Q105	Emitter-Follower Regulator	2N5293
Q106	1/2 Darlington Relay Driver	2N3053
Q107	1/2 Darlington Relay Driver	2N3053
Q108	Regulator Control	2N3565
Q109	Meter Amplifier	2N3053
IC101	Meter Amplifier	CA3018

MONAURAL AUDIO MODULE		
Q201	Amplifier	2N3053
Q202	Buffer-Amplifier	2N3053
IC201	Mono Pre-Emphasis	CA3015
IC202	Amplifier	CA3015
BTS-1B STEREO GENERATOR		
Q301	Buffer-Amplifier	2N4037
Q302	Regulator	2N3053
Q303	Pilot Amplifier	2N3053
Q304	Right Channel Buffer-Amplifier	2N3053
Q305	Buffer-Amplifier	2N3053
Q306	Buffer	2N3053
IC301	76 KHz Oscillator	CA3028
IC302	Divider	MC890P
IC303	Buffer-Amplifier	CA3018
IC304	Right Pre-Emphasis	CA3015
IC306	Buffer	CA3018
Q404	Left Channel Buffer-Amplifier	2N3053
Q405	Buffer-Amplifier	2N3053
Q406	Buffer	2N3053
IC404	Left Pre-Emphasis	CA3015
IC407	Buffer-Amplifier	CA3015
BTX-1B SCA GENERATOR		
Q501	Lamp Driver	2N3053
Q502	Lamp Driver	2N3053
IC501	Amplifier-Modulator	CA3018
IC502	Modulated Oscillator	CA3018
IC503	Buffer	CA3018
IC504	Muting Amplifier	CA3018
IC505	Detector-Buffer-Trigger	CA3018

RECOMMENDED TEST EQUIPMENT

Description	RCA Reference	Other Reference
Exciter Dummy Load and Wattmeter 0-15 / 60 Watts		Bird Electronic Corp. Model 611
Audio Generator		Hewlett-Packard Model 209A
Step Attenuator		Hewlett-Packard Model 350D
Distortion and Noise Meter		Hewlett-Packard Model 331A / 334A
Oscilloscope		Tektronix Model 535A / 535B
Vacuum Tube Voltmeter (VoltOhmyst)	WV-98C	
Grid-Dip Meter		Measurements Corp. Model 59
Stereo Test Fixture	Figure 56	
One 6 foot length of RG-8 / U Cable with type N connectors		
BW-75A Frequency and Modulation Monitor	MI-560735	
BW-85A Stereo FM Monitor	MI-560740	
BW-95A SCA Frequency and Modulation Monitor	MI-560745	

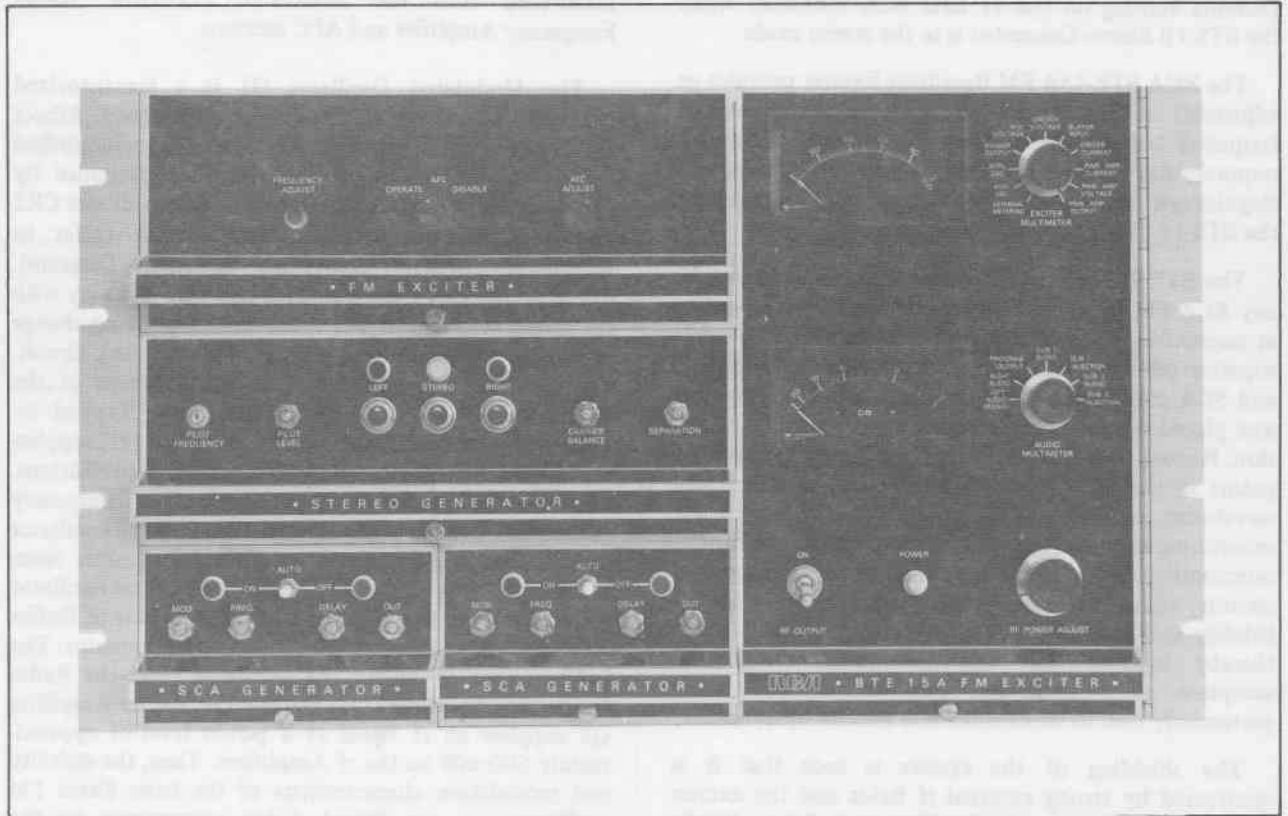

Figure 1. BTE-15A Exciter System

DESCRIPTION

BTE-15A EXCITER SYSTEM

RCA's new FM Multiplex and Stereo System provides on-air FM stations with an inexpensive means of broadcasting two or more services simultaneously over their regularly assigned broadcast channel. Stations can offer background music or other services while retaining presently scheduled FM mono or stereo broadcast programming. The use of the equipment for subsidiary communications and stereo is type accepted by the FCC.

Excellent monaural, stereo and SCA performance that more than meets industry and FCC standards are achieved by the new RCA modular, solid-state, "Direct FM" exciter. This exciter can be substituted directly for the BTE-10C Exciter in present BTF-1E1 or BTF-5/10/20C FM Transmitters and can be operated, for a reasonable period of time, into either a short circuit or open circuit without damage to the output transistor.

New design features include a modular design that plugs into a frame accommodating the Exciter, Power Supply and Switching, BTS-1B Stereo and one or two BTX-1B SCA Generator modules. When operating monaural only, the BTS-1B Stereo Generator is replaced with

another module. The exciter frame is 19 inches wide and designed for standard rack mounting. A module extender is provided to permit easy servicing of modules outside the main frame.

The heart of the system is the new Type BTE-15A Stereo Multiplex Exciter, an all solid-state unit utilizing integrated circuits, and employing RCA's "Direct FM" principle of operation. An important feature of the new exciter system is that it is fully metered using two meters to measure not only operating parameters but also modulating signals.

Stereophonic programming requires the use of an optional plug-in Stereo Generator, Type BTS-1B. One or two Type BTX-1B Subcarrier Generators permit one or two additional program channels to be transmitted along with the regular FM mono program channel. This is accomplished by transferring the subchannel programs into the supersonic frequency range and frequency modulating the subchannel program on 41-67 KHz subcarriers. The FM supersonic carriers are then used to modulate the rf carrier. When a BTS-1B Stereo Generator is switched into the system only one BTX-1B SCA Generator on 67 KHz can be used. A safety feature

prevents turning on the 41 KHz SCA subcarrier when the BTS-1B Stereo Generator is in the stereo mode.

The RCA BTE-15A FM Broadcast Exciter provides an adjustable rf output to 15 watts at any specified frequency between 88 MHz and 108 MHz. All applicable requirements of Section 73.322 of the FCC Rules and Regulations will be met when used in conjunction with the BTS-1B Stereo Subcarrier Generator.

The BTE-15A FM Broadcast Exciter can be used with any RCA FM Broadcast Transmitter which can be driven at carrier frequency. The exciter was designed to provide superior performance under stereophonic, monophonic and SCA conditions. In the design, particular emphasis was placed on ease of maintenance and reliable operation. Printed circuit boards have strategically located test points so that important voltages can be measured and waveforms observed. Two front panel meters allow monitoring of audio levels and exciter functions without interrupting operation. The exciter employs integrated circuits, transistors, and other semi-conductors for reliability and long life. No vacuum tubes are employed, thereby keeping heat dissipation and power consumption to a minimum. The exciter lends itself particularly well to unattended and remote operation.

The shielding of the exciter is such that it is unaffected by strong external rf fields and the exciter cabinet radiation is negligible. The unit is designed to fit into a standard 19 inch rack.

FM EXCITER

Refer to block diagram, Figure 3. The exciter can be

subdivided into the Modulated Oscillator, Radio Frequency Amplifier and AFC sections.

The Modulated Oscillator Q1 is a transistorized oscillator operating at the carrier frequency. Direct frequency modulation of the oscillator is accomplished by varying the oscillator tank circuit capacitance by applying audio modulation to series varicap diodes CR2 and CR3, in the oscillator tank circuit (refer to Modulated Oscillator Simplified Schematic Diagram). The junction capacitance of CR2 and CR3 will vary with the audio modulation and cause a corresponding change in the resonant frequency of the oscillator tank circuit. The carrier frequency deviation is a function of the amplitude of the modulating frequency. Tapped inductor L5, located in the emitter circuit of Q1, supplies the required feedback necessary to sustain oscillations. Capacitor C13 is the oscillator coarse center frequency adjustment and AFC adjust capacitor C14 (an oscillator fine frequency adjustment) is adjusted for proper functioning of the AFC circuit. The output of the oscillator is coupled from the collector of Q1 to the base of Buffer Amplifier Q2, through a 10 dB resistive attenuator. The buffer serves to isolate the oscillator from the Radio Frequency Amplifiers Q3, Q4 and Q5. Buffer Amplifier Q2 supplies an rf signal at a power level of approximately 500 mW to the rf Amplifiers. Thus, the stability and modulation characteristics of the basic direct FM oscillator are not disturbed by adjustments to the following rf power amplifiers. Q3, Q4 and Q5 amplify the 500 mW input to a level of 15 watts nominal output. The basic oscillator, buffer amplifier, and AFC circuits are mounted inside a shielded enclosure. The rf power amplifier is contained in a separate shielded enclosure.

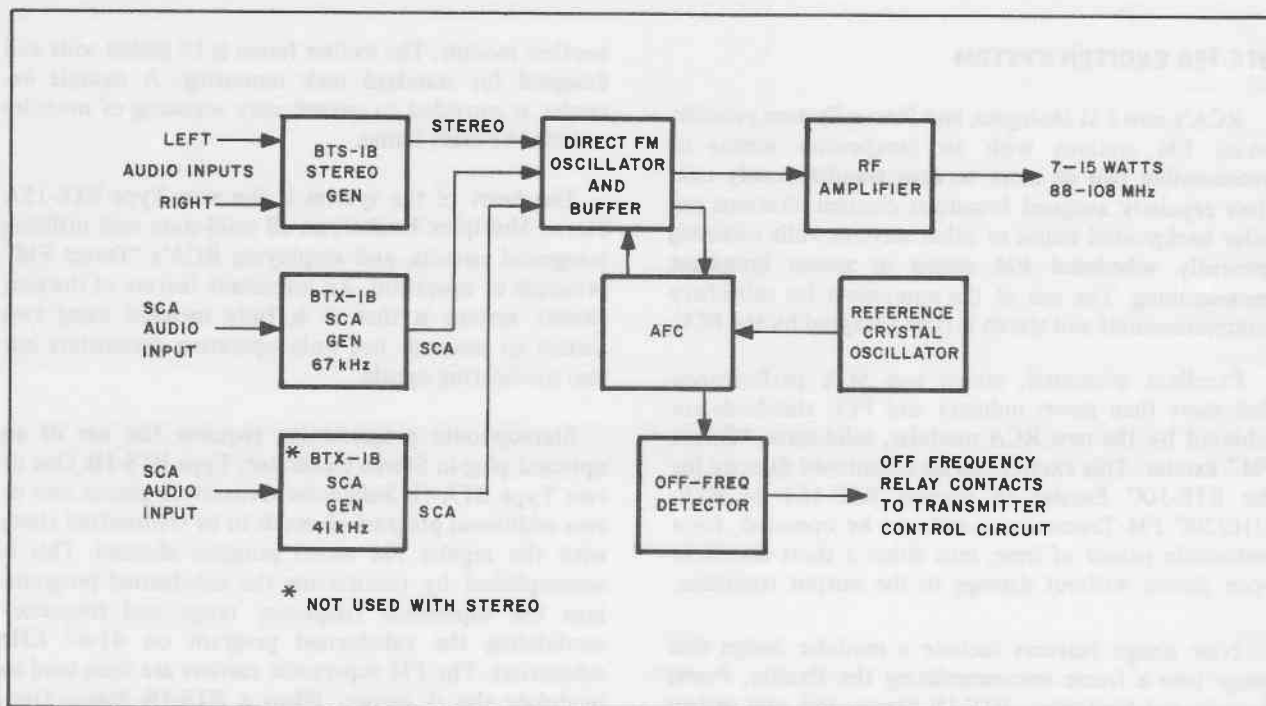

Figure 2. BTE-15A System, Block Diagram

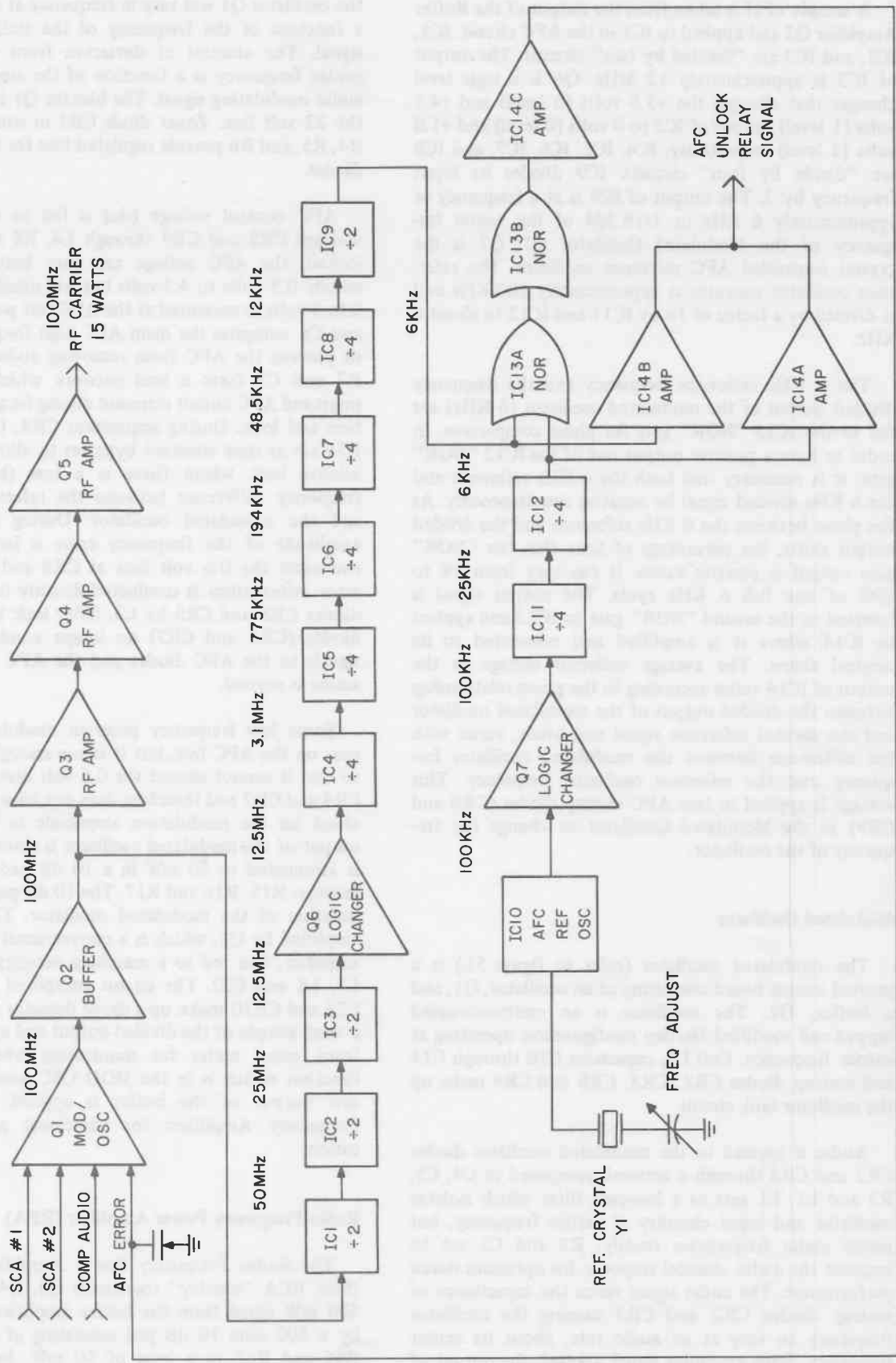

Figure 3. FM Exciter, Simplified Block Diagram

A sample of rf is taken from the output of the Buffer Amplifier Q2 and applied to IC1 in the AFC circuit. IC1, IC2, and IC3 are "divided by two" circuits. The output of IC3 is approximately 12 MHz. Q6 is a logic level changer that changes the +3.5 volts (0 level) and +4.5 volts (1 level) output of IC3 to 0 volts (0 level) and +1.0 volts (1 level) respectively. IC4, IC5, IC6, IC7, and IC8 are "divide by four" circuits. IC9 divides its input frequency by 2. The output of IC9 is at a frequency of approximately 6 KHz or 1/16,384 of the center frequency of the Modulated Oscillator Q1, Q7 is the crystal controlled AFC reference oscillator. The reference oscillator operates at approximately 100 KHz and is divided by a factor of 16 by IC11 and IC12 to about 6 KHz.

The 6 KHz reference frequency and the frequency divided output of the modulated oscillator (6 KHz) are fed to the IC13 "NOR" gate for phase comparison. In order to have a positive output out of the IC13 "NOR" gate, it is necessary that both the 6 KHz reference and the 6 KHz divided signal be negative simultaneously. As the phase between the 6 KHz reference and the divided output shifts, the percentage of time that the "NOR" gate output is positive varies. It can vary from 0% to 50% of one full 6 KHz cycle. The output signal is inverted in the second "NOR" gate in IC13 and applied to IC14 where it is amplified and reinverted to its original shape. The average collector voltage at the output of IC14 varies according to the phase relationship between the divided output of the modulated oscillator and the divided reference signal and hence, varies with the difference between the modulated oscillator frequency and the reference oscillator frequency. This voltage is applied to two AFC varicap diodes (CR8 and CR9) in the Modulated Oscillator to change the frequency of the oscillator.

Modulated Oscillator

The modulated oscillator (refer to figure 51) is a printed circuit board consisting of an oscillator, Q1, and a buffer, Q2. The oscillator is an emitter-coupled tapped-coil modified Hartley configuration operating at carrier frequency. Coil L5, capacitors C10 through C14 and varicap diodes CR2, CR3, CR8 and CR9 make up the oscillator tank circuit.

Audio is applied to the modulated oscillator diodes CR2 and CR3 through a network composed of C4, C5, R3 and L1. L1 acts as a low-pass filter which isolates oscillator and input circuitry at carrier frequency, but passes audio frequencies readily. R3 and C5 act to improve the audio channel response for optimum stereo performance. The audio signal varies the capacitance of varicap diodes CR2 and CR3 causing the oscillator frequency to vary at an audio rate, about its center frequency. With an audio signal applied, the output of

the oscillator Q1 will vary in frequency at a rate which is a function of the frequency of the audio modulating signal. The amount of deviation from the oscillator center frequency is a function of the amplitude of the audio modulating signal. The bias for Q1 is derived from the 22 volt line. Zener diode CR1 in conjunction with R4, R5, and R6 provide regulated bias for the modulator diodes.

AFC control voltage (dc) is fed to the two AFC varicaps CR8 and CR9 through L4, R8 and R9. When locked, the AFC voltage can vary between approximately 0.5 volts to 4.5 volts but will usually be between 2 to 3 volts as measured at the AFC test point, TP13. R8 and C8 comprise the main AFC high frequency roll-off to prevent the AFC from removing audio modulation. R7 and C7 form a lead network which provides an improved AFC circuit response during frequency acquisition and lock. During acquisition CR4, CR7, R74 and R75 act as time constant bypasses to allow the AFC to achieve lock where there is a low (but not zero) frequency difference between the reference oscillator and the modulated oscillator. During this time the amplitude of the frequency error is large enough to overcome the 0.6 volt bias at CR4 and CR7 and the error information is conducted directly to AFC varicap diodes CR8 and CR9 by L3. After lock is achieved the diodes (CR4 and CR7) no longer conduct any error signals to the AFC diodes and the AFC time constant action is normal.

Some low frequency program modulation does appear on the AFC line, but it is low enough in amplitude so that it cannot exceed the 0.6 volt bias present across CR4 and CR7 and therefore does not have any degrading effect on the modulation amplitude or linearity. The output of the modulated oscillator is about 500 mW and is attenuated to 50 mW in a 10 dB pad composed of resistors R15, R16 and R17. The 10 dB pad gives further isolation of the modulated oscillator. The rf signal is amplified by Q2, which is a conventional Class A buffer amplifier, and fed to a matching network consisting of L7, L8 and C22. The circuit composed of R22, R23, C23 and CR10 make up a diode detector which rectifies a small sample of the divided output and applies it to the front panel meter for monitoring when the meter function switch is in the MOD OSC position. The 500 mW output of the buffer is applied to the Radio Frequency Amplifiers for additional power amplification.

Radio Frequency Power Amplifier (RFA)

The Radio Frequency Power Amplifier consists of three RCA "overlay" transistors Q3, Q4 and Q5. The 500 mW signal from the buffer amplifier is attenuated by a 500 ohm 10 dB pad consisting of resistors R60, R61 and R62 to a level of 50 mW. In this manner,

isolation between the buffer amplifier Q2 and the rf amplifier is realized. The rf signal, at a level of 50 mW, is matched to the base circuit of the first rf amplifier Q3, by L12, C59, C60 and C61. The 1.5 watt signal at the collector of Q3 is matched to the base of Q4 by L14, C66, L15 and C68. The 6.0 watt output of Q4 is applied through a matching network consisting of L17, L18, C71, C88, C73 and C86 to the base of Q5. The output of Q5 is a nominal 15 watts rf and is applied to a three-section, pi-matching harmonic filter (L21 through L23 and C76 through C81) used to match the rf output of the rf amplifier to the final 50 ohm load.

AFC Circuit

A small sample of the rf output is fed to IC1, which is a high speed JK flip-flop operating in the current saturated mode. The supply voltage for IC1, IC2 and IC3 is 5 volts and is derived from the +15 volts supply thru a 100 ohm 5 watt resistor, (R56). The divided outputs of IC1, IC2 and IC8 have logic levels of +3.5 volts and +4.5 volts. The input frequency is divided by 2 in each integrated circuit. The output of IC3 is therefore about 12 MHz. Logic level changer Q6 changes the +3.5 volt and +4.5 volt logic levels to 0 volts and +1 volt respectively. The signal is divided by a factor of 4 in dual JK flip-flop IC4. This process is repeated until the output of IC9 at pin 5 is the modulated oscillator frequency divided by 16,384 (IC9 divides by a factor of 2) or approximately 6 KHz. Verification of the presence of the 6 KHz can be observed on the front panel meter with the meter switch in the DIVIDER OUTPUT position. When the last flip-flop of IC9 is oscillating, the average output is about 0.5 volts so that the panel meter reads half scale. If no divided output is present the meter will indicate a reading of less than 20 or more than 90.

The reference oscillator includes IC10 and the reference crystal. The crystal frequency will vary depending on the assigned carrier frequency (refer to Exciter Crystal Data Table). The crystal oscillator frequency will be about 100 KHz. The 100 KHz signal is divided by a factor of 16 for a final reference frequency of approximately 6 KHz.

Phase comparison between the frequency-divided output of the modulated oscillator signal and the reference signal is achieved in IC13, which is a "NOR" gate. A property of the "NOR" gate is that both input signals must be negative at the same time for the output to be positive. As the phase between the 6 KHz reference signal and frequency-divided buffer output signal shifts, the percentage of time that the "NOR" gate output is positive varies. It can vary from 0% to 50% of one full 6 KHz cycle. This signal is inverted in the second "NOR" gate in IC13. It is then amplified and reinverted to its original shape by IC14.

The duty cycle of the waveform at pin 12 (collector)

of IC14 is proportional to the phase angle between the reference signal and the modulated oscillator (buffer) divided output. Therefore, the average voltage at this point varies with phase. R52, C50, R53 and C51 act to integrate or "average" the voltage at IC14, pin 12, which is then fed through the AFC DISABLE-OPERATE switch and L4 to the modulated oscillator AFC varicap diodes. In this fashion, the modulated oscillator center frequency is phase locked to a crystal reference.

If the AFC falls out of lock, the waveform at pin 12 of IC14 will have a low frequency ac component. This ac component is coupled by C45 to the AFC error detector consisting of R44, R45, C46, C47 and CR18. The dc level out of the AFC error detector is used to actuate an "off-frequency" relay in the Main Frame assembly. This relay, K102, is also activated by lack of an output from either the reference divider or the modulated oscillator divider.

The remaining two transistors in IC14 are used as divider output amplifiers. These outputs are ac coupled, rectified into a negative voltage and referenced to the +3.6 volt supply. If a 6 KHz signal from IC13 (the divided reference signal) is fed to pin 6 of IC14, the voltage at the junction of CR14 and C42 is approximately -6 volts dc. If, however, the 6 KHz is not present, no negative voltage is developed across C42 and the junction of CR14 and C42 will rise to +3.6 volts. This causes the voltage across C47 to become positive, thereby closing the AFC unlock relay K102 located on the Main Frame Assembly. The divided modulated oscillator output is processed in the same manner as the divided reference signal and applied across C47.

Resistors R50 and R51 make up a voltage divider which provides the panel meter AFC signal. The panel meter range is such that center scale on the meter corresponds to the center of the AFC lock range. Capacitors C49 and C50, resistors R54 and R55 and diode CR19 comprise the AFC unlock detector which operates the front panel meter when the meter function switch is in the UNLOCK VOLTAGE position.

The crystal oven temperature is controlled by the oven thermostat. The oven thermostat switches oven control transistor Q8 from the "off" to the "on" state at intervals which are a function of oven temperature. Thus, a positive control of oven temperature is established with only a small current through the thermostat contacts. This minimizes problems with oven thermostat contact wear, as well as noise problems. Capacitor C31 is used to slow up the oven ON and OFF time to prevent the introduction of transients into the power supply.

BTS-1B STEREO GENERATOR

Refer to block diagram of the RCA Model BTS-1B. Figure 4. The BTS-1B utilizes unique circuitry to

generate the stereophonic composite waveform. A 76 KHz crystal oscillator drives an integrated circuit frequency divider to provide a frequency stable 38 KHz stereo subcarrier. This has been done in order to minimize the possibility of cross talk into an SCA channel operating in the 67 KHz region. Further, the switching time between the left and right channels is extremely fast, generating an inherently pure stereo signal.

Stereo Carrier and Pilot

The 76 KHz signal is generated in the crystal-controlled multivibrator using IC301. Buffered and amplified by Q301, it is then applied to the first section of the dual binary IC302. This first section delivers push-pull 38 KHz square waves which are applied to buffer amplifiers located in IC303. The outputs of these amplifiers are used to provide the carrier excitation to the series diode modulator. Refer to Figure 52.

The first half of IC302 also drives the second half of that binary, providing a square wave at 19 KHz. This is subsequently amplified by a transistor in IC303, by power amplifier Q303, and sinusoidalized by tuned circuit C311, C312 and L301. Adjusting this tuned circuit slightly one side or the other of resonance will adjust the pilot phase.

Notice that the stereo carrier and pilot waveforms have been generated by digital or switching techniques, leading to an inherently stable generator. There are no linear amplifiers in this portion of the circuitry.

Audio Channels

The two audio channels are similar: one will be discussed first and then will be compared with the second channel, which is adjustable to some extent. Both lead to the modulator.

The audio to both channels is terminated in a resistive pad (R373 through R377 in the right channel and R473 through R477 in the left channel) and drives a transformer to convert from balanced or floating input connection to an unbalanced configuration.

In the case of the left channel, the transformer feeds IC404 to provide gain and the capability of active pre-emphasis. The gain is controlled by the ratio of the sum of R433 and R438, divided by R430. Hence, the gain of this circuit is near unity at low frequencies. But at high frequencies, the feedback ratio is altered by the series network of R431 in series with C414. This network is shunted across the feedback network and so reduces the amount of feedback at higher audio frequencies. This is the method of obtaining pre-emphasis in the BTS-1B.

When 75 microsecond pre-emphasis is desired, C413 and C414 are connected in parallel by strapping. Only C414 is connected when 50 microsecond pre-emphasis is desired, and neither capacitor is connected when flat response is wanted.

The left and right preamplifiers are matched for equal low frequency gain by adjusting the value of R329 so that the sum of R329 and R330 is equal to R430. This sets the two channel gains identical at low frequencies.

At 5 KHz the two channels are matched by adjusting the point where the pre-emphasis takes effect. This is accomplished by adjusting the point in the resistor chain where the RC network is connected. R431 and C414 are connected to a 3300 ohm resistor, R438, which is connected to the emitter of Q404 in the left channel. The corresponding resistance is adjustable in the right channel by adjusting R334.

Adjustment of the two channels for the same time delay is accomplished by adjusting the value of the stopping resistor. In the left channel this is fixed at 47 ohms (R431); in the right channel it is the sum of a 33 ohm fixed resistor (R331) and a 50 ohm variable resistor (R332).

This degree of matching enables the two audio channels, including the following low-pass filters, to be matched to the point where stereo cross talk measurements of the order of 45 dB are obtainable. They are unique with this generator design.

The outputs of the two buffer amplifiers, Q304 and Q404, are fed to the two 17 KHz low-pass filters (FL301 and FL401). These filters are less than 0.5 dB down at 15 KHz, and greater than 50 dB down at 19 KHz and above. This insures an absolute minimum of disturbance to the pilot carrier and subcarrier regions by the program material. Exact equalization of time delay in the 15 KHz region is accomplished by adjustment of 15 KHz phase adjustments C330 and C421.

The outputs of the filters are terminated in their characteristic impedance by R342 and R442 and fed to buffer amplifiers Q305 and Q405. These buffers provide outputs for monaural operation (via the individual gain controls R349 and R449). They are again applied to another pair of buffers, Q306 and Q406, to provide low-impedance drive to the switching modulator. At this point audio output samples are taken for metering purposes via R347 and R447.

Switching Modulator

The series diode switching modulator alternately switches between the left and right audio channels at a 38 KHz rate. The switching time is considerably less than 1 microsecond thereby providing a nearly ideal

stereo signal. The switched signal is almost free from second harmonic components and so provides an inherently clean signal, a characteristic especially important in the SCA (67 KHz) region. CR305 and CR401 form a pair of "AND" gates whose inputs are the audio signals and the 38 KHz excitation. The output of the "AND" gates are summed in an "OR" gate consisting of CR306 and CR402. The summed output is then applied to a buffer amplifier (emitter follower), part of IC306.

The output of this buffer is applied to a phase-linear filter to remove the third and all higher order harmonics of the switching signal. A by-product of this filtering operation is an excess of L-R (difference) signal. This is compensated for by taking a selected amount of L+R (sum) signal and routing it around the switching modulator. This is accomplished with the aid of R354, R454, R357, R358 and R359.

At the base of IC306, Section C, Pin 2, a stereo signal is present consisting of the switched signal, switched alternately between left and right, and a corrective signal consisting of a small amount of the sum of the left and right channels. The output of this stage is applied to the 55 KHz low-pass filter, FL302, through source resistance R363. The pilot signal is added to the input of the filter through resistor R325.

The output of the filter is a high-quality stereophonic waveform which is routed, via contacts on relay K301, to the output buffer amplifier, IC407. This direct-coupled amplifier has sufficient bandwidth to maintain full stereo fidelity far in excess of FCC requirements, and provides a low-impedance source to drive the BTE-15A FM modulated oscillator.

Monaural Operation

If monaural operation is desired, diode-relay logic is incorporated to determine which audio channel should be used and whether the signal should be stereo or monaural. This complex function is provided by relay K301 (selecting stereo or mono), relay K302 (selecting right or left) and diodes CR309 through CR320. Holding contacts on the relays parallel the pushbuttons in order that only a temporary contact closure (of the push-buttons) is required for selection of any mode. In addition, all contacts for the signal selection are brought out on the rear of the unit for full remote control.

MONAURAL AUDIO MODULE

When the BTE-15A FM System is not used for stereophonic transmission, the Monaural Audio Module is used to accept and process the audio input signal.

Refer to Monaural Audio Module schematic diagram, Figure 53. Audio is routed to a resistive input pad, assuring that the driving audio processors, such as the RCA Models BA-46 and BA-47, look into a resistive

load. Following the input pad is a transformer T201, which makes possible the transition from balanced (floating) to unbalanced circuit configuration. The transformer secondary is terminated by R206.

The audio is then applied to an operational-amplifier circuit, IC201, to obtain pre-emphasis by means of frequency-selective negative feedback. This pre-emphasis is field-convertible from standard 75 to a 50 micro-second curve, or it may be strapped with optional components for any other curve, including a flat response. Components have been added to the operational amplifier for stabilization against oscillation.

The output of this preamplifier is applied to a 17 KHz low-pass filter, FL201, which assures that no modulating components above 17 KHz are applied to the BTE-15A FM Exciter, thereby keeping the subcarrier region free of unwanted components for superior SCA transmissions.

The output of this filter is terminated by R219 and applied to a buffer amplifier. Following this is a gain-adjustment control, R223, for vernier adjustment of the module gain. This control may be used in conjunction with the common step-type attenuators in setting the correct degree of modulation of the BTE-15A, or it may be used to standardize the gain of the monaural with that of the RCA BTS-1B Stereo Generator.

The gain control adjusts the level of the program material applied to the output buffer amplifier. This amplifier is heavily controlled with negative feedback to reduce its distortion and output impedance to very low figures. Again, appropriate stabilizing components have been added to this operational amplifier.

The actual output of the monaural audio module is either the output of the operational amplifier IC202, or an external signal, selected by switch S201. If an external signal, such as that from test equipment or a composite studio-to-transmitter link, is applied to the WIDEBAND input jack, located at the rear of the main frame of the BTE-15A, and if the S201 is switched to the External position, then the external signal will be applied to the modulator circuitry in the BTE-15A FM exciter. Return to normal monaural programming is accomplished simply by switching S201 to Monaural.

Internal regulation of power supply voltages is accomplished by a pair of Zener diodes CR201 and CR202 on the printed circuit board. Test points are included to facilitate maintenance checks.

BTX-1B SCA SUBCARRIER GENERATOR

Certain unique options are included in the BTX-1B which set it apart from other SCA Subcarrier Generators. One is the ease of adding radio remote control metering signals. The unit is pre-wired to include this

feature and the metering signals need only be applied to the rear of the unit. The signals are normally in the 20 Hz to 40 Hz range with a level about 15 dB below full modulation of the SCA subcarrier and are not audible on the subscriber's receiver.

Another unique feature is the interchangeability of the modules; the 41 KHz and 67 KHz units may be interchanged on the main frame of the BTE-15A Exciter System and no difference will be observed. This is because of the method of wiring the SCA modules. The main frame is wired in such a manner that both audio input signals go to both SCA connectors, but only to the appropriate pins of each connector. The same technique is employed for the pre-emphasized audio sampling, the injection metering sampling and the external muting.

Test points are included on the BTX-1B for maintenance checks: black is ground, red is for the incoming 15 volt line and orange is for the regulated 10 volt line. The remaining test points follow the standard color code as the signal is traced from input to output: yellow for input audio, green for pre-emphasized audio, blue for the modulated oscillator, violet for the filter input and grey for the output. Test points are not required in the muting section because the front panel lamps provide that function.

Early SCA units employ serial numbers 1 through 999, while later units, with an improved oscillator circuit, employ serial numbers 1000 and up. These boards are directly interchangeable. In the illustrations, figures with the basic number refer to the early boards, while the boards from 1000 up have the suffix "a".

Modulated Oscillator

Refer to the BTX-1B SCA Generator Schematic Diagram, Figure 54(54a), and to the BTX-1B Simplified Block Diagram, Figure 5. Audio is applied to pins 2 and 4 of the input circuitry and is fed through the isolation pad, R501 through R505, to assure that preceding audio processing equipment, such as the BA-43/46 Limiter Amplifier and the BA-43/47 Clipper Amplifier, will see a resistive load. Following the isolation pad is an input transformer, T501, which converts a balanced (floating) to an unbalanced configuration.

Between the transformer and following circuitry is an optional 5 KHz low-pass filter, FL501. The filter in conjunction with external audio processing equipment will prevent higher-order lower side band energy in the 67 KHz SCA signal from penetrating the stereophonic subcarrier region. The modulation control R506 terminates the 5 KHz filter. When stereo is transmitted, it is recommended that the 5 KHz filter (available as MI-560721) be installed and the input be preceded by frequency-sensitive processing such as the RCA BA-47 clipper (normally used with a BA-43 amplifier). Deviation of the SCA signal should be limited to ± 4 KHz when stereo and SCA are transmitted simultaneously.

Following the modulation control is a high-gain audio amplifier IC501 which serves to amplify the incoming modulating signal, thereby eliminating the requirement for a line amplifier, and to provide SCA signal pre-emphasis. The pre-emphasis is obtained by virtue of frequency-selective negative feedback and is field convertible for a standard 150 microsecond or a 75 microsecond curve. The unit may also be strapped for a flat response if desired.

The modulating signal appearing at the output of the audio amplifier (IC501, pin 12) is resistively summed with a dc frequency control voltage at the input to a buffer amplifier (part of IC501). The buffer amplifier is coupled to the modulated oscillator, IC502. The frequency of the modulated oscillator (IC502) is a function of the modulating signal and of the dc control voltage. Frequency adjustment is provided by COARSE FREQ potentiometer R517 and FREQ control (vernier) R515, located on the front panel of the SCA module.

The modulated oscillator output is coupled to a series diode gate consisting of diodes CR505 and CR506. This gate is keyed on and off by a signal from the muting amplifier. The filter (between IC503 terminal 11 and IC503 terminal 6) removes subcarrier harmonics, leaving only the fundamental components. The output of the filter is applied to a buffer amplifier, part of IC503, and then to the output by way of output level adjustment R546.

Muting Circuits

The audio preamplifier drives not only the modulated oscillator but also the muting system. The first section of IC504 is used as a buffer to derive a sample of the pre-emphasized audio to be routed to the metering amplifier printed circuit board (located on the BTE-15A Main Frame). Part of the load impedance for the buffer is the muting sensitivity adjustment R558.

Audio from the muting amplifier (second and third transistor portion of IC504) is fed to a voltage doubler, CR507 and CR508, which drives the first transistor portion of IC505, charging storage capacitor C533. The storage capacitor will charge rapidly with program material applied but has a long discharge time, through DELAY potentiometer R587. The voltage across capacitor C533 is applied to a buffer transistor (the second section of IC505) and then to a Schmitt trigger using the third and fourth sections of IC505. When the input audio level exceeds a certain value, the voltage across C533 rises above a reference level, causing the Schmitt trigger circuit to "fire" and key ON the series diode gate CR505 and CR506 and key the lamp drivers to give a visible indication of the subcarrier status. An RC network consisting of R579, R580, C535 and diode CR509 shape the rise and fall time of the Schmitt trigger output.

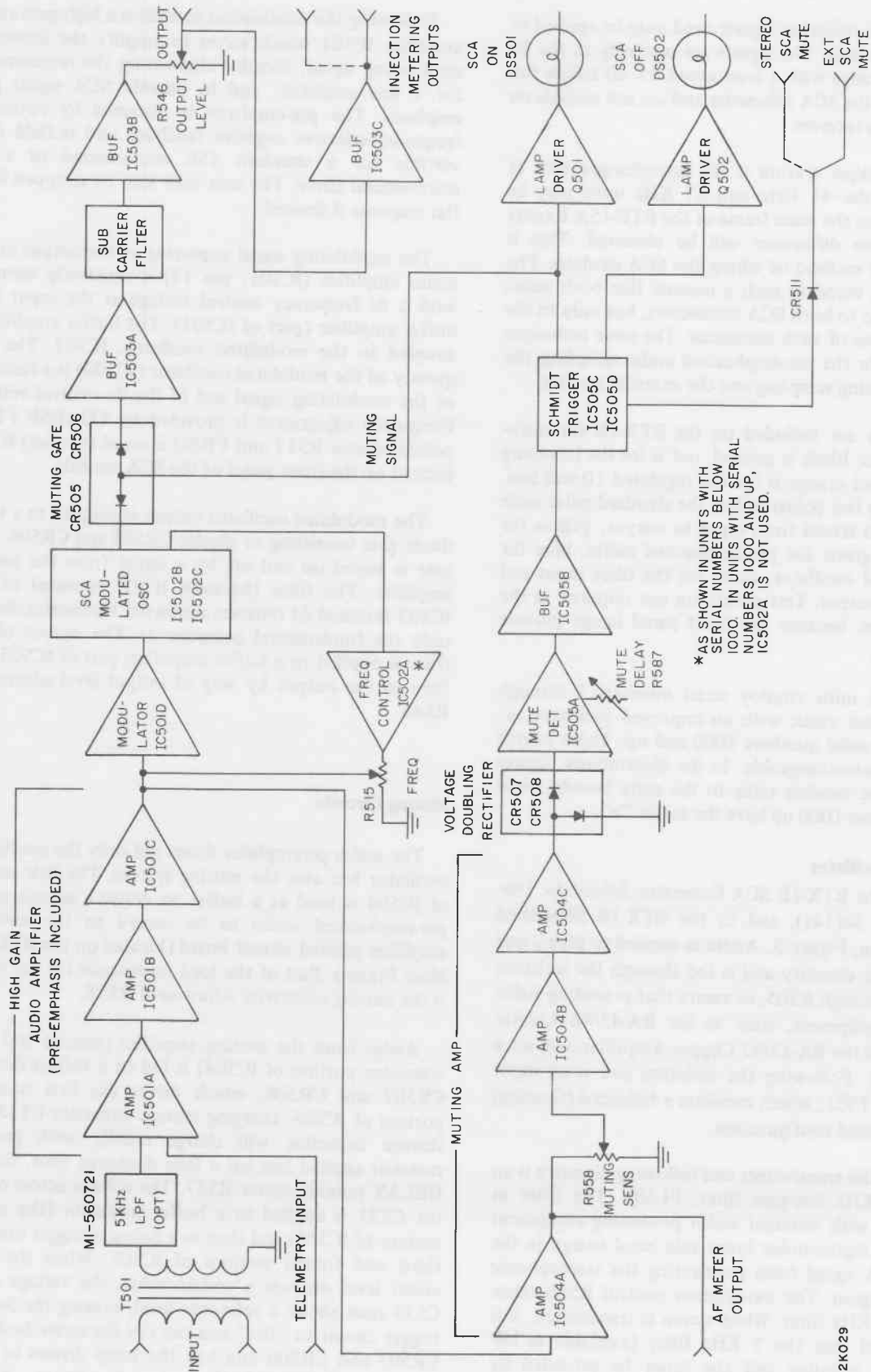

Figure 5. BTX-1B SCA Generator, Simplified Block Diagram

BTE-15A MAIN FRAME

The main frame power supply transformer T101 includes a split and tapped primary for use with 120 or 220 volt primary power. The secondary of the transformer has three windings which deliver after rectification +40V, +20V, -20V, and +5V dc supply voltages. The 40 volt output is regulated to +22 volts by Q101, Q102 and Q108. Q101 and Q102 are used as an emitter-follower, Darlington series pass element, the output of which is controlled by Q108. Zener diode CR106 holds the emitter of Q108 at a fixed reference potential. The output of Q101 is divided down by R106, R107, and R108 and fed to the base of Q108. The difference appears at the collector of Q108 and controls the output of Q101. Adjustment of the output voltage is achieved by R107.

The +20 volt dc output is regulated to +15 volts dc by Q103 acting as an emitter-follower regulator. CR107 is the +15 volt dc reference, and the reference source is the +22 volt supply.

The -15 volt dc supply and +3.6 volt supply operate in the same manner as the +15 volt dc supply. The -15 volt dc supply, however, uses a PNP transistor as a regulator and its own -20 volt input as a reference source.

Off-frequency Shutdown Circuit

An off-frequency detector is incorporated in the design of the BTE-15A FM Exciter. When the basic oscillator frequency is not phase locked to the reference crystal, an ac component appears at the AFC output. This voltage is rectified to operate a relay whose contacts can be used to turn off the FM transmitter.

Q106 and Q107 operate as relay drivers for K102, the AFC Unlock relay. If a phase lock is not realized in the AFC circuitry, a positive voltage is applied to the base of Q107. This turns on Q106 and closes K102. The contacts of K102 can be used to control the output of the FM transmitter.

CB101 is a magnetic breaker intended to be used as both an ON-OFF switch and overload protection for the power line.

K101 is the remotely operated rf power ON-OFF relay which applies +22 volts to the rf amplifier through F101, S103 and R101. F101 protects the power supply from shorts in the rf amplifier circuitry. F101 also protects the rf amplifier from overvoltage. If Q101 should short circuit, applying +40 volts to rf amplifier circuitry, CR101 will conduct heavily and draw enough current through F101 to open it. S103 is a front panel ON-OFF switch for the rf amplifier. R101 is the front panel rf power output control. Only the power to the

last two rf amplifier stages is controlled by R101. This prevents spurious outputs which might be caused by operation of amplifiers at low collector voltages.

Two multimeters are located on the hinged door in front of the regulated power supply section. One of these meters is used to indicate power supply and operating voltages within the exciter and three stage rf Amplifier. The second meter is a peak-reading voltmeter that is used to indicate key modulating signals.

S101 is the monitor meter (M101) selector switch. Position 1 is the EXTERNAL METERING position, and the meter leads are directly available at J101, pins 3 and 4.

The modulated oscillator (MOD. OSC) position indicates the detected output of the oscillator buffer chain (Q1 and Q2).

The XTAL OSC position measures the collector voltage on the last binary (IC9) in the reference frequency (crystal oscillator) divider chain. If the indication is approximately center scale, both the oscillator and the oscillator divider chain are operating. If not, the meter will read either less than 20 or more than 90.

The DIVIDER OUTPUT position samples the collector voltage of the last binary in the modulated oscillator divider chain. Again, if the indication is approximately center scale, operation is normal. If the dividers are not functioning normally, the reading will be less than 20 or more than 90.

The AFC VOLTAGE position measures the output of the AFC circuitry which is used to drive the AFC varicap diode in the modulated oscillator. It should read approximately center scale and be controllable by the AFC ADJUST knob (C14) on the front of the FM exciter module.

The UNLOCK VOLTAGE position indicates the presence of an AFC unlock voltage if present.

The BUFFER INPUT position reads the base bias developed on the first rf amplifier transistor Q3.

The DRIVER CURRENT position measures the collector current of the second rf amplifier transistor. The POWER AMP CURRENT position similarly measures the third and last rf amplifier collector current. The POWER AMP VOLTAGE position indicates the supply voltage to the last two rf amplifier transistor stages.

The POWER AMP OUTPUT position monitors a small sample of the rf voltage at rf output connector J2. The indication is affected by VSWR and can be used as a reliable indication of power output only when the output is terminated by a 50 ohm resistive load. C105,

C106, L101 and L102 comprise a power line input filter which prevents leakage of rf either into or out of the unit via the line cord.

Meter Amplifier

The audio and SCA modules in the BTE-15A FM Exciter System provide outputs for sampling audio and program levels and relative SCA injection. These are routed to the calibration controls near the front of the metering amplifier circuit board, located in the power supply compartment, and then to the selector switch S102. S102 selects which sample is to be applied to the metering amplifier.

The metering amplifier itself consists of a 5-stage circuit. The first stage is of relatively high input impedance and high gain. This is followed by a second stage, designed for somewhat lower gain, good linearity and low output impedance. This second stage is followed by a pair of emitter followers, (Darlington configuration) for current amplification. The second of these emitter followers, the fourth section of IC101, is coupled through blocking capacitor C121 to power amplifier Q109. Q109 is forward biased by means of

temperature-sensing diode CR116. The non-linear transfer characteristic of Q109 results effectively in rectification of the audio signal. Positive peaks therefore charge capacitor C122 to the peak value of the selected waveform. To accomplish rapid charging of C122 large values of current are required, and this is the reason for the large amount of current amplification in the amplifier.

Capacitor C122 can discharge only through resistor R126 via the meter M102. This discharge rate has been chosen to approximately follow the audio envelope; the resulting meter movement is similar to the station's modulation monitor or typical VU meter. However, because of the extremely rapid charging rate possible, the system will respond correctly to very short program signal bursts. Further, because the transient signals are routed around the meter multiplier resistor R126 by capacitors C123 and C124, the actual meter movement is accelerated, especially on the upswing. R127 critically damps the meter and so controls the overshoot.

More sophisticated than an elementary VU meter, this peak-reading multimeter with its complete system monitoring capability enables the broadcaster to accurately measure parameters in the BTE-15A heretofore measured only by oscilloscopes or similar complex equipment.

INSTALLATION

MAIN FRAME

The BTE-15A main frame is 19 inches wide and 10-1/2 inches high and is designed for standard rack mounting. All connections are made to the rear of the unit. It houses the FM Exciter, Stereo Generator (or Monaural Audio Module), and one or two SCA Generators (or SCA Generator Blank Panels). It may be operated with 117V, 208V or 240 volts 50/60 Hz input.

CAUTION

Make certain that T101 is properly connected for the voltage input at J103. Refer to Figure 55.

Connections

1. Terminate the exciter rf output jack J2, using a suitable 50 ohm dummy load (this may be the transmitter rf input circuit).

2. If necessary, change primary connections to exciter power transformer T101, for operation at the available line voltage. See Figure 55. AC line power is applied to exciter main frame power connector J103.

NOTE: In RCA BTF-5E1, BTF-10E1, and BTF-20E1 FM transmitters, exciter AC line voltage should be connected at transmitter terminals 1TB1-13 and 1TB1-14.

3. To secure rf output it is also necessary to energize the coil of remote power "ON-OFF" relay K101. The relay normally supplied incorporates a 240 volt operating coil, which is operated by application of 240 volts (AC) to exciter terminals J101-1 and J101-2. This voltage is supplied in RCA BTF-5E1, BTF-10E1, and BTF-20E1 transmitters when transmitter connector 1P5 is connected to exciter connector J101.

NOTE: If 240 volts AC is not available to operate K101, other voltages may be used, provided that a new relay (K101) is substituted which is compatible with the voltage used (at J101-1 and J101-2).

4. Power output should now be available from the exciter when RF OUTPUT switch S103 is set to the ON position. The rf power output may be set by simply varying the setting of RF POWER ADJUST rheostat R101.

FM EXCITER

The BTE-15A FM exciter is mounted in and receives power from the main frame. All connections are made to the main frame, including input and output connections.

STEREO GENERATOR

The BTS-1B stereo generator is mounted in the main frame of the BTE-15A exciter system or it may be mounted in a special smaller frame by itself, as a retrofit for the BTS-1A stereo generator. In either case, power is derived from the main frame. All connections are made to the main frame, including power, remote control

connections (if used), audio input(s) from the signal source or audio processors and the output connection.

SCA GENERATOR

The BTX-1B SCA generator is normally mounted in the main frame of the BTE-15A exciter system or it may be mounted in a special smaller frame by itself, as a retrofit for the RCA BTX-1A SCA generator. In either case, power is derived from the main frame. All connections are made to the main frame including power, remote control connections (if used), audio input from the signal source or audio processors and the output connection, either the subcarrier itself or the complete output of the BTE-15A exciter.

TUNING

BTE-15A RF AMPLIFIER (RFA)

NOTE: This is not a complete tuning procedure. It is to be used only following a transistor replacement or other malfunction such that the RFA is known to have been operating properly at one time. If it is desired to alter the frequency to which the exciter is tuned, it is recommended that the unit be returned to RCA for this purpose.

1. Disconnect the BTE-15A from the transmitter and connect it through a wattmeter to a 50 ohm dummy load of 25 watts or greater power handling ability.

2. Mount the exciter drawer on the extender and loosen the two nuts on either end of the RFA. Rotate the RFA toward the rear and remove the cover plate to expose the RFA tuning adjustments.

CAUTION

Use only a *completely* insulated tuning tool.

3. Apply power to the exciter and turn the POWER control fully clockwise.

NOTE: The RFA has been previously tuned. Therefore, it should not be necessary to turn any control more than 10° from its original position. It might be well to mark the original positions before beginning to adjust the unit.

4. The interstage matching networks each contain two controls which *must* be adjusted as a pair, for an

optimum condition. This is done as follows:

A. Adjust one of the capacitors in a pair for a maximum of power output as read on the wattmeter.

B. *Slightly* detune the other capacitor of the pair to reduce the power out by 2-3 watts.

C. Adjust the first capacitor again for a peak in power. If this peak is greater than the previous one, again slightly detune the second capacitor in the same direction as before.

D. Repeat the first capacitor and continue this procedure until no further improvement can be noted.

If the first readjustment resulted in a lower power out, the second capacitor should be detuned the opposite way.

When tuning the RFA it is important to start at the beginning and work straight through. **DO NOT GO BACK.** When all adjustments have been made, go back to the beginning and go straight through a second or third time, until no further improvement can be noted. A minimum expected power output after this procedure is 17.5 watts.

The capacitor pairs to be adjusted are, in order, C59 and C61, C66 and C68, C71 and C73.

Do not adjust the six output matching capacitors unless the previous procedure fails to produce a minimum of 17.5 watts output.

These capacitors are also adjusted in pairs, as follows: C76 and C77, C78 and C79, C80 and C81.

The RFA now has optimum power output. All that remains is to broad-band it and verify stability.

Apply 100 Hz sinusoidal modulation of sufficient amplitude to modulate the exciter 133%.

Place the EXCITER MULTIMETER switch in the PWR AMP OUTPUT position.

Connect an oscilloscope so that the Y axis is deflected by voltage between C83 on the RFA and ground, and the X axis is deflected by the 100 Hz modulation input.

The audio oscillator, Exciter, and Oscilloscope now form a sweep generator and detector. The more nearly horizontal and flat the scope trace, the better the RFA tuning.

Go through the RFA as previously described, adjusting the coupling networks *very slightly* for a flat, horizontal scope trace, simultaneously watching the wattmeter to see that power out does not drop below 15 watts.

After a preliminary adjustment has been made, slowly turn the POWER control towards minimum, simultaneously watching the scope trace. The amount of incidental AM (shown by tilt or bumps in the scope trace) will change. It is necessary to adjust the RFA so that a compromise condition is reached, and the incidental AM is not too severe at any power level.

When adjusting power out and observing the scope, if any "stairsteps", or discontinuities are noted at any power level, adjust the RFA so as to eliminate them. They represent instabilities due to improper tuning and must not be present at any power setting when tuning is completed.

As a final adjustment to flatten the passband of the RFA, slightly tune C22 for minimum incidental AM.

When tuning is complete, the BTE-15A should deliver at least 15 watts in a 50 ohm dummy load. The sweep output on the oscilloscope should be reasonably flat at all settings of the POWER control, and there will be no discontinuities in the sweep response at any power level.

BTS-1B STEREO GENERATOR

NOTE: To obtain an L=R stereo signal, feed the LEFT and RIGHT audio channels from a common audio generator and connect in phase. To obtain an L=-R stereo signal reverse one channel so that the RIGHT and LEFT audio are 180° out of phase. The circuit diagram for an easily fabricated test fixture, which may be employed to facilitate stereo tests, is given in Figure 56. An RCA Type BW-85A Stereo Modulation Monitor is recommended for the following tests.

1. Set all controls and adjustments on the BTS-1B Stereo Generator to the maximum counterclockwise position.
2. Set PILOT LEVEL (R322, Front Panel) at minimum.
3. Read the 38 KHz TEST position on the BW-85A monitor and adjust the BTS-1B CARRIER BALANCE control (R356, Front Panel) for a 38 KHz null.
4. Set the BW-85A function switch to the TOTAL MODULATION position and apply a 50 Hz L=R audio input.
5. Adjust the audio level so that the BW-85A monitor reads 90% on the TOTAL MODULATION range and then turn the BW-85A FUNCTION selector to the L-R position and observe the level indicated on the monitor.
6. Adjust the 50 Hz ADJ CONTROL (R329, on printed circuit board) for null as indicated by the monitor while in the L-R MODULATION position.
7. Change the frequency of the audio generator to 5 KHz but leave the audio phase conditions set for L=+R. Set the audio generator level to read 90% modulation as indicated in the TOTAL MODULATION position on the monitor.
8. Adjust 5 KHz ADJ CONTROL (R334, on PC board) for null as read in the L-R MODULATION position on the BW-85A monitor.
9. Set the frequency of the audio oscillator to 15 KHz while still feeding the audio in the L=+R phase. Set the level of the audio oscillator to indicate 90% modulation as read in the TOTAL MODULATION position of the BW-85A monitor.
10. Set the 15 KHz ADJ CONTROL (R332 on PC Board) for null as indicated in the L-R position of the stereo monitor.
11. Both the 5 KHz ADJ and 15 KHz ADJ adjustments should be rechecked for best null as indicated in the L-R MODULATION position of the monitor.
12. Set the frequency of the audio generator to 5 KHz and leave the phase of the audio in the L=+R condition.
13. Adjust 50 Hz ADJ for null as indicated in the L-R MODULATION position of the stereo monitor FUNCTION switch.
14. Set the SEPARATION control (R359, on the Front Panel) to minimum resistance (CCW).

15. Set the audio generator to 10 KHz and switch the phase of the audio to L=R. Set the signal generator level to read 90% modulation on the BW-85A monitor as indicated in the TOTAL MODULATION position.

16. Adjust SUB to MAIN (R357, on PC Board) for null as indicated in the L+R MODULATION position of the stereo monitor.

17. Turn the FUNCTION selector switch on the stereo monitor to the PILOT MODULATION position and set PILOT LEVEL (R322, on the Front Panel) to read approximately 5% modulation.

18. Adjust the PILOT PHASING (L301, on PC Board) for maximum on the meter as indicated in the PILOT MODULATION position on the stereo monitor. Readjust the PILOT LEVEL control for 10% injection.

19. Feed LEFT only at 13 KHz to the stereo generator and adjust the input level of the audio generator to produce 100% modulation as indicated in the TOTAL MODULATION position on the BW-85A monitor.

20. Switch the monitor FUNCTION switch to the L+R MODULATION position. Read and note the level indicated.

21. Switch the FUNCTION selector to the L-R MODULATION position and note this reading. Adjust the SEPARATION control (R359, on Front Panel) until the level indicated agrees with the level indicated in step 20. At this time switching between L+R and L-R on the stereo monitor FUNCTION switch should produce the same indication on the meter.

22. Readjust the audio level for 100% modulation as indicated in the TOTAL MODULATION position on the stereo monitor. Switch to the RIGHT channel only position and read the separation.

NOTE: If a BW-85A stereo monitor is used, verify that the monitor phase adjustment is optimum. See monitor alignment procedure for details.

23. Carefully adjust SEPARATION control (R359) and PILOT PHASE control (L301) for best separation.

24. Adjust FILTER TERMINATION (R366, on PC Board) for best separation. Stereo separation should be 33 dB or better.

25. With no audio input applied and the AUDIO MULTIMETER switch set to PROGRAM OUTPUT, check that there is no deflection on AUDIO MULTIMETER M102. If necessary, adjust METER ZERO control R129.

26. Set the audio generator frequency to 400 Hz. Set the level to 10 dBm. Push the LEFT monaural button on the front panel of the stereo generator.

27. Adjust the LEFT MONO GAIN control (R449, on PC Board) for 100% modulation as read with the BW-85A FUNCTION switch set to the TOTAL MODULATION position.

28. Move the output of the audio oscillator to the RIGHT input connector and press the RIGHT monaural button on the front panel of the stereo generator.

29. Adjust the RIGHT MONO GAIN control (R349, on PC Board) for 100% modulation, read with the BW-85A FUNCTION switch set to the TOTAL MODULATION position.

30. Switch the stereo generator to the STEREO mode and apply a 400 Hz L=R signal. Set audio generator level to produce 100% modulation as read with the BW-85A FUNCTION switch set to the TOTAL MODULATION position.

31. With the AUDIO MULTIMETER switch (on BTE-15A main frame) set to the LEFT AUDIO (MONO) position, set calibration control R136, designated LEFT CAL, for an indication of 0 dB on AUDIO MULTIMETER M102. Calibration control R136 (and other associated calibration controls) are located on the meter amplifier and power supply regulator printed circuit board in the main frame.

32. Set the AUDIO MULTIMETER switch to the RIGHT AUDIO position. Adjust calibration control R135, designated RIGHT CAL, for an indication of 0 dB on AUDIO MULTIMETER M102.

33. Set the AUDIO MULTIMETER switch to the PROGRAM OUTPUT position. Adjust PGM CAL control R134 for an indication of 0 dB on AUDIO MULTIMETER M102.

BTX-1B SCA GENERATOR

1. If both stereophonic and SCA operation are planned, it is recommended that the optional 5 KHz low-pass filter (MI-560721) be included in the BTX-1B SCA Generator. This unit immediately follows input transformer T501, when supplied. Use of this filter prevents higher-order lower sideband energy in a 67 KHz SCA signal from penetrating the stereophonic subcarrier region. This filter is available as optional MI-560721. Installation details for MI-560721 are shown in Figure 57.

NOTE: The following SCA Generator Adjustment procedure requires the use of an FCC approved multiplex monitor, such as the RCA BW-95A.

2. Set the front panel control switch S501 to the ON position. This holds the subcarrier on regardless of whether or not there is audio modulation present.

3. Adjust front panel control R515 (designated FREQ) for the proper SCA subcarrier frequency. If necessary, reset coarse SCA subcarrier frequency control R517 as required. This adjustment should be made without modulation applied to the SCA generator.

4. Adjust the SCA Generator output level control R546 (designated OUT on the front panel) for the desired degree of injection to the BTE-15A (or other) exciter. Injection is usually set at 9 to 10% when stereo is transmitted and 10 to 20% with monaural signals. With monaural programming the arithmetic sum of the modulation of the main carrier by SCA subcarriers should not exceed 30 percent.

5. With the AUDIO MULTIMETER switch (on BTE-15A main frame) set to the SUB 1 INJECTION position, set calibration control R132, designated SCA 1 INJ, for an indication of 0 dB on AUDIO MULTIMETER M102. Calibration control R132 (and other associated calibration controls) are located on the meter amplifier and power supply regulator printed circuit board in the main frame.

6. Now apply audio modulation to the SCA channel. Set the SCA monitor for measurements on the SCA subcarrier frequency in use. Advance the MOD control (R506, at SCA Generator front panel) until the SCA monitor modulation meter indicates the desired degree of deviation of the subcarrier. Where the BTX-1B is used in conjunction with a BTE-15A exciter, the exciter AUDIO MULTIMETER switch should be set to the SUB 1 AUDIO position. The AUDIO MULTIMETER should indicate near the zero dB calibration mark. If not, reset the SUB 1 MOD control R133 as required.

7. Note that the AUDIO MULTIMETER on the BTE-15A is peak-reading, and will respond correctly to the instantaneous value of modulation regardless of modulating waveform, whether it be a sine wave or program material.

8. If two SCA channels are to be used, repeat steps 2, 3, 4, 5 and 6 for the second SCA generator. In this

case the AUDIO MULTIMETER switch is set to the SUB 2 INJECTION and SUB 2 AUDIO positions and control R130, designated SCA 2 INJ, is used to calibrate the AUDIO MULTIMETER (with the AUDIO MULTIMETER switch set to the SUB 2 INJECTION position) and R131 (SUB 2 MOD) is used to normalize the audio multimeter reading (in the SUB 2 AUDIO position of the meter switch).

Couple the BTX-1B output to an SCA receiver, or alternatively, if preferred, the normal BTX-1B / BTE-15A combination may be used, with a suitable main channel demodulator included.

Switch the BTX-1B control switch to the AUTO position. Adjust the DELAY control, R587, until the receiver handles the signal as smoothly as possible. It is suggested that a delay of between 1 and 2 seconds be used. This control adjusts only the time lag between disappearance of audio and the muting of the subcarrier: It does *not* control the subcarrier envelope rise and fall time.

Each BTX-1B SCA generator is supplied with an MI-560721 5 kHz low pass filter, installed. When stereo is transmitted, it is strongly suggested that the SCA generator audio input be preceded by frequency-sensitive processing equipment such as the RCA BA-47 Clipper, to prevent higher-order lower sideband SCA components from penetrating the frequency spectrum occupied by the stereo signal.

Deviation of the SCA signal should be limited to ± 4 KHz when stereo and SCA are transmitted simultaneously.

TYPICAL PANEL METER READINGS		
Meter Position	P _{out}	
	15 W	10 W
MOD OSC	43	43
XTAL OSC	65	65
DIVIDER OUTPUT	55	55
AFC VOLTAGE	60	60
UNLOCK VOLTAGE	4	4
BUFFER INPUT	24	20
DRIVER CURRENT	35	30
PWR AMP CURRENT	48	37
PWR AMP VOLTAGE	40	32
PWR AMP OUTPUT	48	36

Note: Readings taken with exciter terminated in a 50 ohm dummy load.

TYPICAL WAVEFORMS, BTS-1B STEREO GENERATOR

1. Waveforms taken with a Tektronix Type 531A oscilloscope with type H plug-in and 10X probe. The Tektronix Type 535A, 535B or equivalent may be used.
2. Squares on graticule equal 1 centimeter (horizontally and vertically); $\mu\text{sec}/\text{cm}$ refers to sweep time base, and V/cm refers to vertical calibration.

GROUP 1

400 Hz audio fed to left stereo generator input (J109).

No signal input to right stereo generator input (J110).

Audio level set for ± 75 kHz deviation of carrier, including 9% pilot.

Stereo mode.

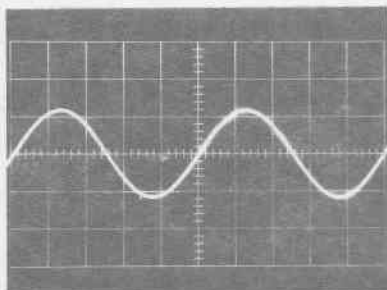

*TP408 (yellow); Left Input
1 V/cm, .5 ms/cm
Sync: Ext. audio generator

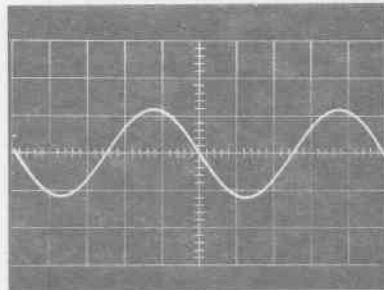

*TP409 (yellow); 17 kHz Filter Input
1 V/cm, .5 ms/cm
Sync: Ext. audio generator

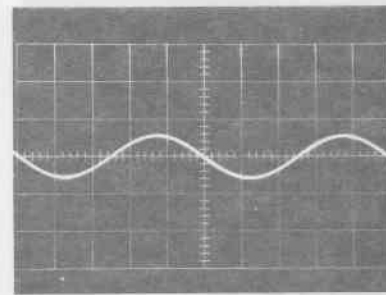

*TP410 (yellow); 17 kHz Filter Output
1 V/cm, .5 ms/cm
Sync: Ext. audio generator

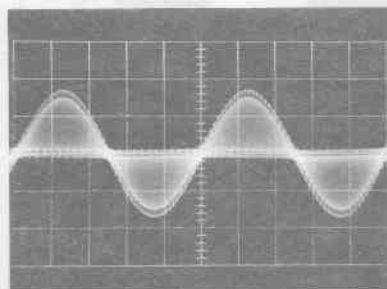

TP411 (white); Composite Output
1 V/cm, .5 ms/cm
Sync: Ext. audio generator

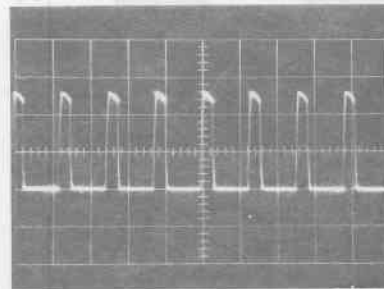

TP301 (yellow); 76 kHz
2 V/cm, 10 $\mu\text{sec}/\text{cm}$
Sync: Ext. from TP304

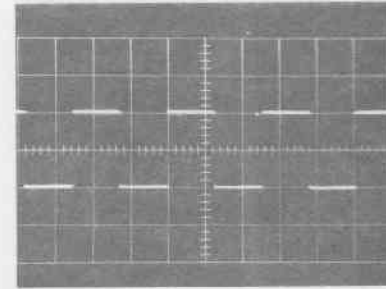

TP302 (green); 38 kHz #1
2 V/cm, 10 $\mu\text{sec}/\text{cm}$
Sync: Ext. from TP304

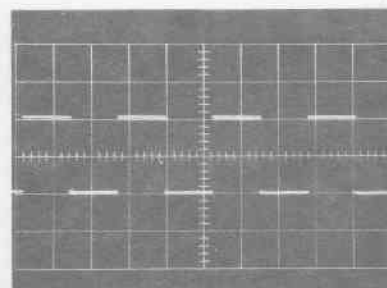

TP303 (green); 38 kHz #2
2 V/cm, 10 $\mu\text{sec}/\text{cm}$
Sync: Ext. from TP304

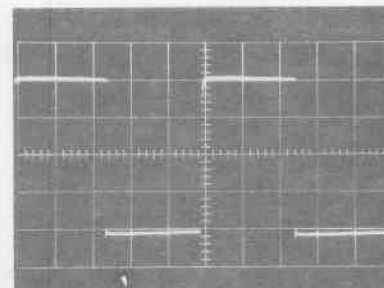

TP304 (blue); 19 kHz
2 V/cm, 10 $\mu\text{sec}/\text{cm}$
Sync: Ext. from TP304

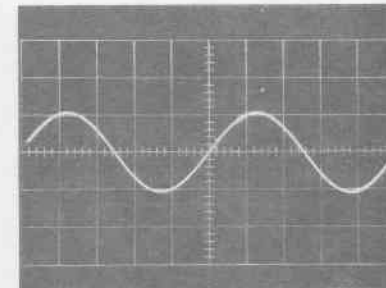

Junction of L301 and R325; Pilot Signal
1 V/cm, 10 $\mu\text{sec}/\text{cm}$
Sync: Ext. from TP304

*With a signal input to the right stereo generator input (J110), these waveforms will appear at TP308, TP309 and TP310.

Figure 5a. Typical Waveforms, BTS-1B Stereo Generator

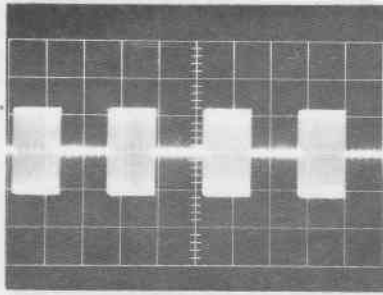

TP311 (green); Switch
.5 V/cm, 10 μ sec/cm
Sync: Ext. from TP304

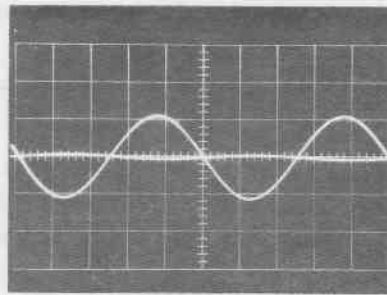

TP311 (green); Switch
.5 V/cm, .5 ms/cm
Sync: Ext. audio generator

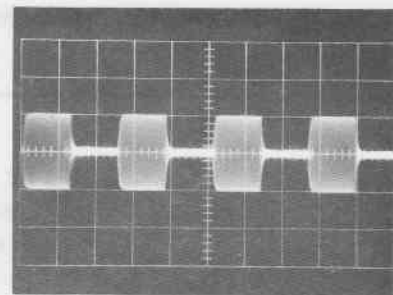

TP312 (blue); Switch
.5 V/cm, 10 μ sec/cm
Sync: Ext. from TP304

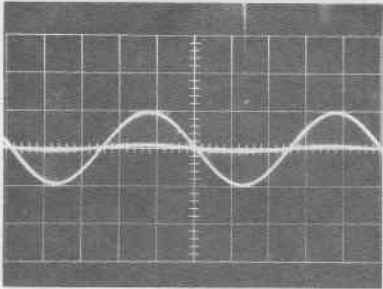

TP312 (blue); Switch
.5 V/cm, .5 ms/cm
Sync: Ext. audio generator

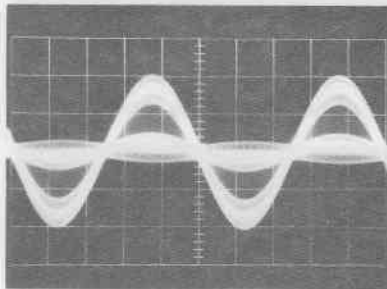

TP313 (violet); Unfiltered Stereo
.1 V/cm, .5 ms/cm
Sync: Ext. audio generator

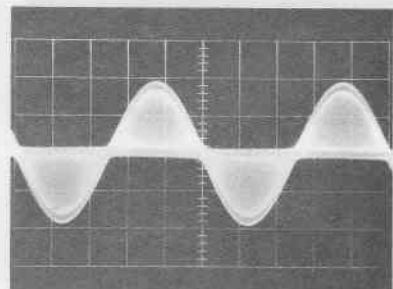

TP314 (gray); 55 kHz Filter Output
.1 V/cm, .5 ms/cm
Sync: Ext. audio generator

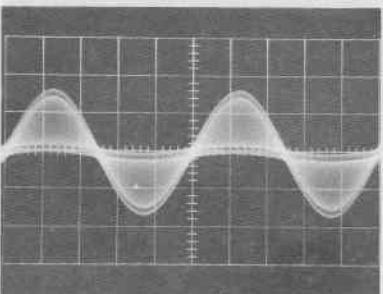

TP411 (white); Composite Output
1 V/cm, .5 ms/cm
Sync: Ext. audio generator
Waveform showing insufficient amplitude of L-R signal.

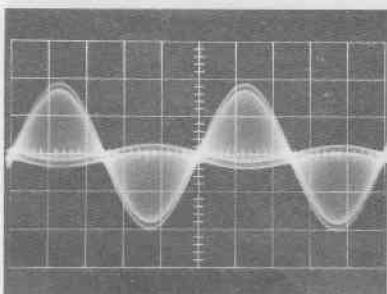

TP411 (white); Composite Output
1 V/cm, .5 ms/cm
Sync: Ext. audio generator
Waveform showing excessive amplitude of L-R signal.

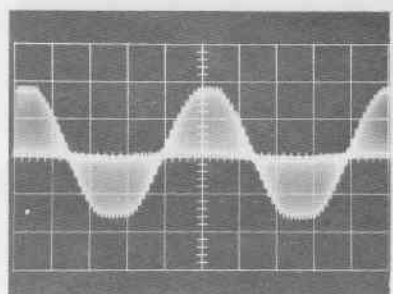

TP411 (white); Composite Output
1 V/cm, .5 ms/cm
Sync: Ext. audio generator
Waveform showing effect of extreme overmodulation; input level increased to give more than 200% modulation.

Figure 5a (continued). Typical Waveforms, BTS-1B Stereo Generator

GROUP 2

400 Hz audio fed to left (J109) and right (J110) stereo generator inputs, phased such that L=-R.
Audio level set for ± 75 kHz deviation of carrier, including 9% pilot.

Stereo mode.

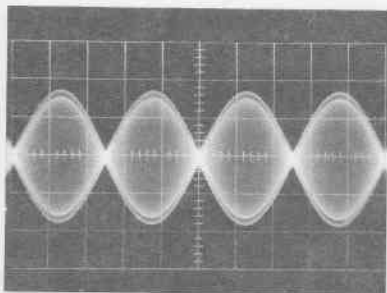

TP411 (white); Composite Output
1 V/cm, .5 ms/cm
Sync: Ext. audio generator
Normal L-R waveform

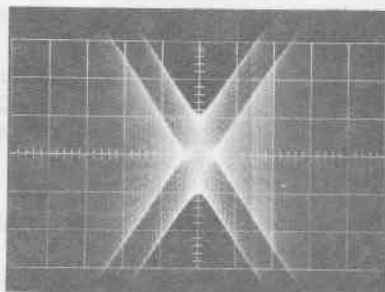

TP411 (white); Composite Output
.1 V/cm, 50 μ sec/cm
Sync: Ext. audio generator
Photo to left expanded to show
waveform when pilot phase
is properly adjusted.

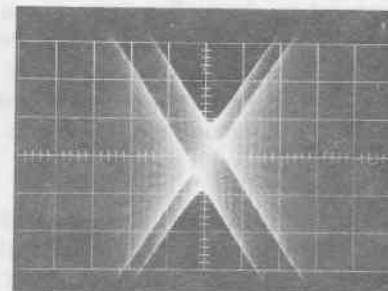

TP411 (white); Composite Output
.1 V/cm, 50 μ sec/cm
Sync: Ext. audio generator
Photo to left expanded to show
waveform when pilot phase
is misadjusted.

GROUP 3

400 Hz audio fed to left (J109) and right (J110) stereo generator inputs, phased such that L=R.
Audio level set for ± 75 kHz deviation of carrier, including 9% pilot.

Stereo mode.

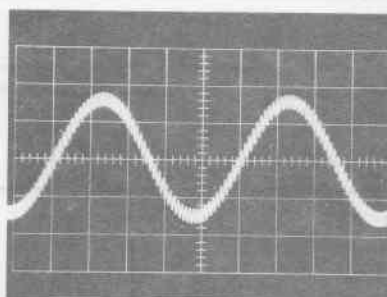

TP411 (white); Composite Output
1 V/cm, .5 ms/cm
Sync: Ext. audio generator
Normal L+R waveform.

GROUP 4

9% pilot injection (9% modulation of carrier due to pilot).

Stereo mode.

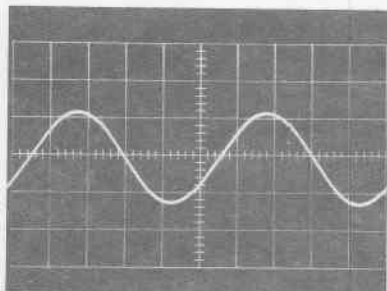

TP411 (white); Composite Output
.1 V/cm, 10 μ sec/cm
Sync: Ext. from TP304 No left
or right input, normal pilot
only signal without modulation.

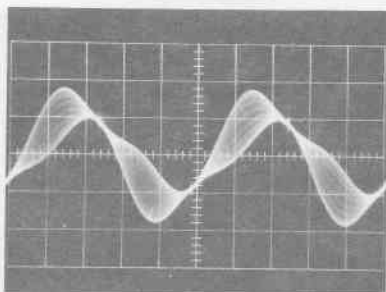

TP411 (white); Composite Output
.1 V/cm, 10 μ sec/cm
Sync: Ext. from TP304 Left only
input at J109; audio level set
for 15% modulation of carrier,
including 9% pilot. This waveform
may be used to identify the
left channel.

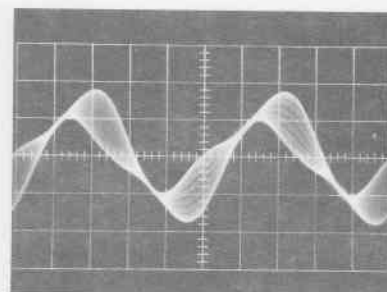

TP411 (white); Composite Output
.1 V/cm, 10 μ sec/cm
Sync: Ext. from TP304 Right only
input at J110; audio level set
for 15% modulation of carrier,
including 9% pilot. This waveform
may be used to identify the
right channel.

Figure 5a (continued). Typical Waveforms, BTS-1B Stereo Generator

PARTS ORDERING INFORMATION

REPLACEMENT PARTS

Replacement parts bearing a Stock Number should be ordered by Item, Description, and Stock Number from RCA, Distributor and Special Products Division, Deptford, New Jersey 08096. Items listed under a Master Item (MI) Number should be ordered from RCA, Commercial Communications Systems Division, Camden, NJ 08102.

Because of possible products modifications and/or the unavailability of parts, the item which will be supplied against an order for a replacement part may not be an exact duplicate of the original part. As a result, some of the replacement parts received may require a mount-

ing modification of the customer's design. In some cases, parts and/or instructions for adapting the substitute parts will be supplied. In no way will the substitute parts impair the operation or performance of the equipment.

For information regarding the use of any parts received, write RCA, Tech Alert, Bldg. 2-8, Camden, NJ 08102, or call (609) 963-8000 Extension PC-3434.

EMERGENCY PART SERVICE

For emergency part service after working hours, contact RCA Distributor and Special Products Division, Telephone 609-963-8000 or 609-848-5900.

LOCATION	ORDERING INSTRUCTIONS
Continental United States, including Alaska and Hawaii	<p>Replacement Parts bearing a STOCK NUMBER should be ordered from RCA Distributor and Special Products Division – 2000 Clements Bridge Road – Deptford, NJ 08096.</p> <p>Replacement Parts bearing a MASTER ITEM (MI) NUMBER should be ordered from RCA, Commercial Communications Systems Division – Camden, NJ 08102 or your nearest RCA Regional Office.</p> <p>Replacement Parts with NO STOCK or MASTER ITEM (MI) NUMBER are standard components. They are not stocked by RCA and should be obtained from your local electronics distributor.</p>
Dominion of Canada	Order from your local RCA Sales Representative or his office or from: RCA Victor Limited, 1001 Lenoir Street, Montreal, Quebec.
Outside of Continental United States, Alaska Hawaii, and the Dominion of Canada	<p>Order from your local RCA Sales Representative or from: RCA International Division, Clark, NJ – U.S.A. – Wire: RADIOINTER</p> <p>Emergency: Cable RADIOPARTS, DEPTFORD, NJ</p>

REPLACEMENT PARTS

Symbol	Stock No.	Drawing No.	Description
			BTE-15A FM EXCITER ES-560631
			BTE-15A RF EXCITER UNIT MI-560712
			P/L 3720225-501 REV 4
1		3456736-	BTE-15A RF EXCITER UNIT
			CAPACITORS
C1	240846		CERAMIC, .001 MF 1000 V
C2	240846		CERAMIC, .001UF 1000 V
C3	240846		CERAMIC, .001UF 1000 V
C4	423738		TANTALUM, 33 MF 4 V
C5	244247		CERAMIC, 22 PF 1000V
C6	107323		CERAMIC, 270 PF 1000 V
C7	249941		CERAMIC, 0.47 MF 50V
C8	423736		TANTALUM, 2.2 MF 20 V
C9	423739		CERAMIC, .22UF 35V
C10	244392		CERAMIC, 15 PF N750 (NOMINAL)
C11	244329		CERAMIC, 15 PF NPD (NOMINAL)
C12	244329		CERAMIC, 15 PF NPD (NOMINAL)
C13	245164		VARIABLE, 2.4-24.5 PF 500V
C14	245165		VARIABLE, 1-13 PF
C15	107323		CERAMIC, 270 PF 1000 V
C16	245166		CERAMIC, 33 PF NPD
C17	107323		CERAMIC, 270 PF 1000 V
C18	107323		CERAMIC, 270 PF 1000 V
C19	248251		ELECTROLYTIC, 150 MF 15 V
C20	107323		CERAMIC, 270 PF 1000 V
C21	107323		CERAMIC, 270 PF 1000 V
C22	245164		VARIABLE, 2.4-24.5 PF 500V
C23	240846		CERAMIC, .001 MF 1000 V
C24	107323		CERAMIC, 270 PF 1000 V
C25	427229		ELECTROLYTIC, 1500UF AT 25V
C26	THRU		
C30	245167		CERAMIC, .001 MF 500 V
C31	245168		ELECTROLYTIC, 100 MF 20V
C32	219663		MICA, 10 PF 500 V
C33	240846		CERAMIC, .001 MF 1000 V
C34	240846		CERAMIC, .001 MF 1000 V
C35	240846		CERAMIC, .001 MF 1000 V
C36	127801		CERAMIC, .01 MF 100V
C37	127801		CERAMIC, .01 MF 100V
C38	423664		ELECTROLYTIC, 1 MF 35 V
C39	239235		VARIABLE, 3-34 PF
C40	426768		FILM .0182 MF 2% 100V
C41	THRU		
C44	127801		CERAMIC, .01 MF 100V
C45	245163		ELECTROLYTIC, 22 MF 20 V
C46	248374		FILM, .022 MF 2% 100 V
C47	245163		ELECTROLYTIC, 22 MF 20 V
C48	127801		CERAMIC, .01 MF 100V
C49	423739		ELECTROLYTIC, 0.22 MF 35 V
C50	247837		ELECTROLYTIC, 0.1 MF 35 V
C51	247837		ELECTROLYTIC, 0.1 MF 35 V
C52	THRU		
C58	245167		CERAMIC, .001 MF 500 V
C59	245171		VARIABLE, 3-25 PF 500 V
C60	245166		CERAMIC, 33 PF NPD
C61	245171		VARIABLE, 3-25 PF 500 V
C62	245167		CERAMIC, .001 MF 500 V
C63	245167		CERAMIC, .001 MF 500 V
C64	432444		CERAMIC, .01 MF 500V
C65	425984		TANTALUM, 6.8 MF 35 V
C66	245171		VARIABLE, 3-25 PF 500 V
C67	245167		CERAMIC, .001 MF 500 V
C68	245171		VARIABLE, 3-25 PF 500 V
C69	245167		CERAMIC, .001 MF 500 V
C70	432444		CERAMIC, .01 MF 500V

Symbol	Stock No.	Drawing No.	Description
C71	245171		VARIABLE, 3-25 PF 500 V
C72	245167		CERAMIC, .001 MF 500 V
C73	245171		VARIABLE, 3-25 PF 500 V
C74	245167		CERAMIC, .001 MF 500 V
C75	432444		CERAMIC, .01 MF 500V
C76	THRU		
C81	245171		VARIABLE, 3-25 PF 500 V
C82	121291		CERAMIC, 2.2 PF
C83	245167		CERAMIC, .001 MF
C84	423664		ELECTROLYTIC, 1MF 35V
C86	127396		CERAMIC, 10 PF NPO
C87	219215		CERAMIC, 22 PF NPO
C88	109316		CERAMIC, 15 PF NPO
C89	232927		CERAMIC, 0.47 MF 3 V
C90	232927		CERAMIC, 0.47 MF 3 V
C91	232927		CERAMIC, 0.47 MF 3 V
C92	248250		CERAMIC, 4.7 PF NPO
C93	423735		ELECTROLYTIC, 0.1UF 35V
C94	423736		ELECTROLYTIC, 2.2 MF 20 V
C95	240846		CERAMIC, .001MF 1000V
C96	248253		TANTALUM, 27 MF 35 V
C97	248253		TANTALUM, 27 MF 35 V
C98	423736		ELECTROLYTIC, 2.2UF 20V
C99	432444		CERAMIC, .01 MF 500V
C100	236617		TANTALUM, 22MF 35V 5%
CR1	424857		DIODE - TYPE 1N5240B ZENER
CR2	245173		DIODE, VARICAP - TYPE MV840
CR3	245173		DIODE, VARICAP - TYPE MV840
CR4	234552		DIODE - TYPE 10D2
CR7	234552		DIODE - TYPE 10D2
CR8	245173		DIODE, VARICAP - TYPE MV840
CR9	245173		DIODE, VARICAP - TYPE MV840
CR10			
THRU			
CR21	242220		DIODE - TYPE 1N4154
CR23	426189		DIODE - TYPE 1N4151
CR24	248254		DIODE, ZENER - TYPE 1ZC30T5 -
IC1	245174		INTEGRATED CIRCUIT - TYPE MC1027P
IC2	245175		INTEGRATED CIRCUIT - TYPE MC1013P
IC3	245175		INTEGRATED CIRCUIT - TYPE MC1013P
IC4	THRU		
IC9	429606		INTEGRATED CIRCUIT - TYPE MC9802P
IC10	CA3028B		INTEGRATED CIRCUIT - TYPE CA3028B
IC11	420547		INTEGRATED CIRCUIT - TYPE MC890P
IC12	420547		INTEGRATED CIRCUIT - TYPE MC890P
IC13	423737		INTEGRATED CIRCUIT - TYPE MC825P
IC14	244345		INTEGRATED CIRCUIT - TYPE CA301B
J1	223973		CONNECTOR - BNC
J2	223973		CONNECTOR - BNC
L1	245173		CHOKE - 2.7 UH
L3	245178		CHOKE - 2.7 UH
L4	245179		CHOKE - 20 H
L5	245180		COIL - OSCILLATOR
L6	245178		CHOKE - 2.7 UH
L7	245178		CHOKE - 2.7 UH
L8	245181		CHOKE - 0.47 UH
L9	245178		CHOKE - 2.7 UH
L10	245182		CHOKE - 0.1 H
L11	245183		CHOKE - 150 UH
L12	245184		CHOKE
L13	245741		CHOKE
L14	245186		CHOKE
L15	245185		CHOKE
L16	245741		CHOKE
L17	248257		CHOKE
L18	245186		CHOKE
L19	245132		CHOKE - 2.4 UH
L20			CHOKE, 3 TURNS #18 AWG W 1/4 IN DIA
L21	245187		CHOKE

Symbol	Stock No.	Drawing No.	Description
L22	245187		CHOKE
L23	245187		CHOKE
L24	245182		CHOKE - 0.1 H
L25	248256		CHOKE - 1 MH
Q1	247994		TRANSISTOR - TYPE 2N4427
Q2	247994		TRANSISTOR - TYPE 2N4427
Q3	2N3866		TRANSISTOR - TYPE 2N3866
Q4	2N4440		TRANSISTOR - TYPE 2N4440
Q5	2N5102		TRANSISTOR - TYPE 2N5102
Q6	236267		TRANSISTOR - TYPE 2N3640
Q7	2N4037S		TRANSISTOR - TYPE 2N4037
Q8	2N5293		TRANSISTOR - TYPE 2N5293
P1	248258		CONNECTOR - BNC
P2	248266		CONNECTOR
			RESISTORS FIXED COMP UNLESS NOTED
R1	426219	99206-080	33K OHMS 10% 1/4W
R2	426219	99206-080	33K OHMS 10% 1/4W
R3	108869	99206-076	15K OHMS 10% 1/4W
R4	219458	99206-056	330 OHMS 10% 1/4 W
R5	108866	99206-066	2200 OHMS 10% 1/4W
R6	108864	99206-058	470 OHMS 10% 1/4W
R7	108871	99206-082	47,000 OHMS 10% 1/4 W
R8	232389	99206-094	470,000 OHMS 10% 1/4 W
R9	223769	99206-086	100,000 OHMS 10% 1/4 W
R10	218499	99206-074	10,000 OHMS 10% 1/4 W
R11	426232	99206-038	10 OHMS 10% 1/4W
R12	426213	99206-070	4700 OHMS 10% 1/4W
R13	108865	99206-062	1000 OHMS 10% 1/4 W
R14	426233	99206-042	22 OHMS 10% 1/4W
R15	230605	99206-043	27 OHMS 10% 1/4 W
R16	226975	99206-045	39 OHMS 10% 1/4 W
R17	230605	99206-043	27 OHMS 10% 1/4 W
R18	426232	99206-038	10 OHMS 10% 1/4W
R19	426213	99206-070	4700 OHMS 10% 1/4W
R20	108865	99206-062	1000 OHMS 10% 1/4 W
R21	502047	82283-127	47 OHMS 10% 1/4W
R22	108865	99206-062	1000 OHMS 10% 1/4 W
R23	227755	99206-090	220,000 OHMS 10% 1/4 W
R24	134744		33 OHMS 10% 5W WW
R25	108866	99206-066	2200 OHMS 10% 1/4 W
R26	108866	99206-066	2200 OHMS 10% 1/4 W
R27	108861	99206-050	100 OHMS 10% 1/4 W
R28	218758	99206-054	220 OHMS 10% 1/4 W
R29	108866	99206-066	2200 OHMS 10% 1/4 W
R30	108865	99206-062	1000 OHMS 10% 1/4 W
R31	108866	99206-066	2200 OHMS 10% 1/4 W
R32	502010	82283-111	10 OHMS 10% 1/4W
R35	108861	99206-050	100 OHMS 10% 1/4 W
R36	108865	99206-062	1000 OHMS 10% 1/4 W
R37	108865	99206-062	1000 OHMS 10% 1/4 W
R38	426213	99206-070	4700 OHMS 10% 1/4W
R39	223769	99206-086	100,000 OHMS 10% 1/4 W
R40	108865	99206-062	1000 OHMS 10% 1/4 W
R41	426213	99206-070	4700 OHMS 10% 1/4W
R42	223769	99206-086	100,000 OHMS 10% 1/4 W
R43	108866	99206-066	2200 OHMS 10% 1/4 W
R44	218499	99206-074	10,000 OHMS 10% 1/4 W
R45	218499	99206-074	10,000 OHMS 10% 1/4 W
R46	218499	99206-074	10,000 OHMS 10% 1/4 W
R47	108865	99206-066	2200 OHMS 10% 1/4 W
R48	426112	99206-078	22,000 OHMS 10% 1/4W
R49	426112	99206-078	22,000 OHMS 10% 1/4W
R50	223769	99206-086	100,000 OHMS 10% 1/4 W
R51	108869	99206-076	15,000 OHMS 10% 1/4 W
R52	218499	99206-074	10,000 OHMS 10% 1/4 W
R53	218499	99206-074	10,000 OHMS 10% 1/4 W
R54	108869	99206-076	15,000 OHMS 10% 1/4 W
R55	218499	99206-074	10,000 OHMS 10% 1/4 W

Symbol	Stock No.	Drawing No.	Description
R56	430178		WIREWOUND, 100 OHMS 10% 5W
R57	502222	82283-066	2200 OHMS 10% 1/2 W
R58	502222	82283-066	2200 OHMS 10% 1/2 W
R59	502247	82283-070	4700 OHMS 10% 1/2 W
R60	502027	82283-043	27 OHMS 10% 1/2 W
R61	502039	82283-045	39 OHMS 10% 1/2 W
R62	502027	82283-043	27 OHMS 10% 1/2 W
R63	502010	82283-038	10 OHMS 10% 1/2 W
R64	502047	82283-046	47 OHMS 10% 1/2 W
R65	502310	82283-074	10,000 OHMS 10% 1/2 W
R66	237939		0.24 OHMS 5% 2 W
R67	502027	82283-043	27 OHMS 10% 1/2W
R68	502247	82283-070	4700 OHMS 10% 1/2 W
R69	241643	82283-525	2.2 OHMS 10% 1/2W
R70	502047	82283-046	47 OHMS 10% 1/2 W
R71	502247	82283-070	4700 OHMS 10% 1/2 W
R72	502247	82283-070	4700 OHMS 10% 1/2 W
R73	502368	82283-084	68,000 OHMS 10% 1/2 W
R74 THRU			
R77	218499	99206-074	10K OHMS 10% 1/4W
R78	502210	82283-062	1000 OHMS 10% 1/2 W
R79	108861	99206-050	100 OHMS 10% 1/4W
R80	108864	99206-058	470 OHMS 10% 1/4W
S1	245191		SWITCH
XIC1			
THRU			
XIC9	423743		SOCKET-STRIP OF 7
XIC10	423740		SOCKET
XIC11	423743		SOCKET-STRIP OF 7
XIC12	423743		SOCKET-STRIP OF 7
XIC13	423743		SOCKET-STRIP OF 7
XIC14			NOT USED
XQ1	422416		SOCKET, 2N4427
XQ2	422416		SOCKET, 2N4427
XQ3	248259		SOCKET - TYPE 2N3866
XQ4	248248		SOCKET - TYPE 2N4440
XQ5	248248		SOCKET - TYPE 2N5102
XQ6	422416		SOCKET - TYPE 2N3640
XQ7	422416		SOCKET - TYPE 2N4037
XQ8	248369		SOCKET - TYPE 2N5293
XY1	423741		SOCKET-CRYSTAL OVEN
Y1			CRYSTAL - SEE MI-560717
Z1	245741		CHOKE - RF
Z2	245741		CHOKE - RF
Z3	245741		CHOKE - RF
Z4 THRU			
Z14	245132		REACTOR FERRITE BEAD
MECHANICAL			
16	248375		COUPLER - SHAFT
	423774		FINGER STRIP-8 IN. LENGTH
22	248370		IC PAD, WHITE
23	248377		PAD - INTEGRATED CIRCUIT, WHITE
25	423742		KNOB 1/4 IN DIA (C14)
27	229767		KNOB 1/8 IN DIA (S1)
41	430892		HEAT SINK
51	248249		SHOCK MOUNT - FM SUBCHASSIS
	423774		FINGER STRIP

Symbol	Stock No.	Drawing No.	Description
			B
			BTS-1B STEREO GENERATOR MI-560713 M/L 3720216-501 REV 3
			CAPACITORS
C301	243352		VARIABLE, 2.2-34 PF 500V
C302	217378		MICA, 15 PF 500 V
C303	238220		MICA, 470 PF 500 V
C304	248378		FILM, 0.1 MF 10% 100 V
C305	248379		FILM, .047 MF 10% 100 V
C306	248379		FILM, .047 MF 10% 100 V
C307	223777		ELECTROLYTIC, 47 MF AT 20 V
C308	79191		MICA, 330 PF 500 V
C309	223777		ELECTROLYTIC, 47 MFD 20 V
C310	223777		ELECTROLYTIC, 47 MFD 20 V
C311	248379		FILM, .047 MF 10% 100 V
C312	248380		FILM, .0068 MF 10% 100 V
C313	248387		FILM, .012 MF 10% 100V
C314	248374		FILM, .022 MF 2% 100 V
C315	215198		MICA, 33 PF 500 V
C316	215198		MICA, 33 PF 500 V
C317	237797		ELECTROLYTIC, 15MF 20V
C318	237797		ELECTROLYTIC, 15 MF 20 V
C320	223777		ELECTROLYTIC, 47 MF 20 V
C321	432444		CERAMIC, .01 MF 10% 100V
C322	223777		ELECTROLYTIC, 47 MF 20 V
C325	223777		ELECTROLYTIC, 47 MF 20 V
C326			
THRU			
C329	432444		CERAMIC, .01 MF 10% 600V
C330	248265		VARIABLE, 10-70 PF
C413	248387		FILM, .012 MF 10% 100V
C414	248374		FILM, .022 MF 2% 100 V
C415	215198		MICA, 33 PF 500 V
C416	215198		MICA, 33 PF 500 V
C417	237797		ELECTROLYTIC, 15 MF 20 V
C418	237797		ELECTROLYTIC, 15 MF 20 V
C420	223777		ELECTROLYTIC, 47 MF 20 V
C421	248265		VARIABLE, 10-70 PF
C423	216971		MICA, 22 PF 500 V
C424	221678		MICA, 47 PF 500V
CR301	242220		DIODE = TYPE 1N4154
CR302	242220		DIODE = TYPE 1N4154
CR303	225312		DIODE, ZENER = TYPE 1ZC10T10
CR304	225312		DIODE, ZENER = TYPE 1ZC10T10
CR305	242220		DIODE = TYPE 1N4154
CR306	242220		DIODE = TYPE 1N4154
CR309			
THRU			
CR320	234552		DIODE = TYPE 10D2
CR401	242220		DIODE = TYPE 1N4154
CR402	242220		DIODE = TYPE 1N4154
DS301	245152		LAMP = LEFT
DS302	245153		LAMP = STEREO
DS303	245154		LAMP = RIGHT
FL301	245158		FILTER - LOW-PASS, 17 KHZ
FL302	245159		FILTER - LOW-PASS, 55 KHZ
FL401	245158		FILTER - LOW-PASS, 17 KHZ
IC301	CA3028B		INTEGRATED CIRCUIT = TYPE CA3028B
IC302	420547		INTEGRATED CIRCUIT = TYPE MCB90P
IC303	244345		INTEGRATED CIRCUIT = TYPE CA3018
IC304	CA3015A		INTEGRATED CIRCUIT = TYPE CA3015
IC306	244345		INTEGRATED CIRCUIT = TYPE CA3018
IC404	CA3015A		INTEGRATED CIRCUIT = TYPE CA3015

Symbol	Stock No.	Drawing No.	Description
1C407	CA3015A		INTEGRATED CIRCUIT - TYPE CA3015
K301	246420		RELAY
K302	246420		RELAY
L301	245155		COIL = 10 MH NOM, PILOT PHASE
L302	245182		CHOKER = 0.1 H
P301	248266		CONNECTOR
Q301	2N4037S		TRANSISTOR - TYPE 2N4037
Q302			
THRU			
Q306	2N3053S		TRANSISTOR - TYPE 2N3053
Q404	2N3053S		TRANSISTOR - TYPE 2N3053
Q405	2N3053S		TRANSISTOR - TYPE 2N3053
Q406	2N3053S		TRANSISTOR - TYPE 2N3053
			RESISTORS - FIXED COMP UNLESS NOTED
R303	502210	82283-062	1000 OHMS 10% 1/2 W
R304	502210	82283-062	1000 OHMS 10% 1/2 W
R305	502210	82283-062	1000 OHMS 10% 1/2 W
R306	502222	82283-066	2200 OHMS 10% 1/2 W
R307	502147	82283-058	470 OHMS 10% 1/2 W
R308	502147	82283-058	470 OHMS 10% 1/2 W
R309	502222	82283-066	2200 OHMS 10% 1/2 W
R310	502222	82283-066	2200 OHMS 10% 1/2 W
R311	502047	82283-046	47 OHMS 10% 1/2 W
R312	502222	82283-066	2200 OHMS 10% 1/2 W
R313	502210	82283-062	1000 OHMS 10% 1/2 W
R314	502222	82283-066	2200 OHMS 10% 1/2 W
R315	502222	82283-066	2200 OHMS 10% 1/2 W
R316	502210	82283-062	1000 OHMS 10% 1/2 W
R317	502210	82283-062	1000 OHMS 10% 1/2 W
R318	502210	82283-062	1000 OHMS 10% 1/2 W
R319	502310	82283-074	10,000 OHMS 10% 1/2 W
R320	502010	82283-038	10 OHMS 10% 1/2 W
R321	502110	82283-050	100 OHMS 10% 1/2 W
R322	431102		VARIABLE, 1000 OHMS
R323	502133	82283-056	330 OHMS 10% 1/2 W
R324	502222	82283-066	2200 OHMS 10% 1/2 W
R325	502347	82283-082	47,000 OHMS 10% 1/2 W
R326	522043	99126-126	43 OHMS 5% 2W
R327	522110	99126-050	100 OHMS 10% 2 W
R328	502168	82283-060	680 OHMS 10% 1/2 W
R329	243748		VARIABLE, 10,000 OHMS
R330	502247	82283-070	4700 OHMS 10% 1/2 W
R331	502033	82283-044	33 OHMS 10% 1/2 W
R332	423747		VARIABLE, 50 OHMS
R333	502256	82283-071	5600 OHMS 10% 1/2 W
R334	234008		VARIABLE, 2000 OHMS
R335	502310	82283-074	10,000 OHMS 10% 1/2 W
R336	502222	82283-066	2200 OHMS 10% 1/2 W
R337	502222	82283-066	2200 OHMS 10% 1/2 W
R338	502233	82283-171	3300 OHMS 5% 1/2W
R339	502147	82283-058	470 OHMS 10% 1/2 W
R340	502247	82283-070	4700 OHMS 10% 1/2 W
R341	431212		4990 OHMS 1% 1/2W
R342	431212		4990 OHMS 1% 1/2W
R343	502247	82283-070	4700 OHMS 10% 1/2 W
R344	502122	82283-054	220 OHMS 10% 1/2 W
R345	502247	82283-070	4700 OHMS 10% 1/2 W
R346	502047	82283-046	47 OHMS 10% 1/2 W
R347	502310	82283-074	10,000 OHMS 10% 1/2 W
R348	502247	82283-070	4700 OHMS 10% 1/2 W
R349	423748		VARIABLE, 10,000 OHMS
R350	502310	82283-074	10,000 OHMS 10% 1/2 W
R351	502310	82283-074	10,000 OHMS 10% 1/2 W
R352	502247	82283-070	4700 OHMS 10% 1/2 W
R353	502247	82283-070	4700 OHMS 10% 1/2 W
R354	502222	82283-066	2200 OHMS 10% 1/2 W
R355	502247	82283-070	4700 OHMS 10% 1/2 W
R356	431102		VARIABLE, 1000 OHMS

Symbol	Stock No.	Drawing No.	Description
R357	423746		VARIABLE - 1000 OHMS
R358	502310	82283-074	10,000 OHMS 10% 1/2 W
R359	245157		100,000 OHMS 10% 1/2 W
R360	502322	82283-078	22,000 OHMS 10% 1/2 W
R361	502247	82283-070	4700 OHMS 10% 1/2 W
R362	502247	82283-070	4700 OHMS 10% 1/2 W
R363	502222	82283-066	2200 OHMS 10% 1/2 W
R364	502247	82283-070	4700 OHMS 10% 1/2 W
R365	502222	82283-066	2200 OHMS 10% 1/2 W
R366	423746		VARIABLE, 1000 OHMS
R373	502118	82283-053	180 OHMS 10% 1/2 W
R374	502118	82283-053	180 OHMS 10% 1/2 W
R375	502133	82283-056	330 OHMS 10% 1/2 W
R376	502118	82283-053	180 OHMS 10% 1/2 W
R377	502118	82283-053	180 OHMS 10% 1/2 W
R378	502410	82283-086	100,000 OHMS 10% 1/2 W
R379	522168	99126-060	680 OHMS 10% 2 W
R380	227777		WIREWOUND, 1000 OHMS 10% 5 W
R381	522168	99126-060	680 OHMS 10% 2 W
R382	522168	99126-060	680 OHMS 10% 2 W
R383	227777		WIREWOUND, 1000 OHMS 10% 5 W
R384	502110	82283-050	100 OHMS 10%, 1/2 W
R428	502168	82283-060	680 OHMS 10% 1/2 W
R430	502310	82283-074	10,000 OHMS 10% 1/2 W
R431	502047	82283-046	47 OHMS 10% 1/2 W
R433	502268	82283-072	6800 OHMS 10% 1/2 W
R435	502310	82283-074	10,000 OHMS 10% 1/2 W
R436	502222	82283-066	2200 OHMS 10% 1/2 W
R437	502222	82283-066	2200 OHMS 10% 1/2 W
R438	502239	82283-173	3900 OHMS 5% 1/2W
R439	502147	82283-058	470 OHMS 10% 1/2 W
R440	502247	82283-070	4700 OHMS 10% 1/2 W
R441	431212		4990 OHMS 1% 1/2W
R442	431212		4990 OHMS 1% 1/2W
R443	502247	82283-070	4700 OHMS 10% 1/2 W
R444	502122	82283-054	220 OHMS 10% 1/2 W
R445	502247	82283-070	4700 OHMS 10% 1/2 W
R446	502047	82283-046	47 OHMS 10% 1/2 W
R447	502310	82283-074	10,000 OHMS 10% 1/2 W
R448	502247	82283-070	4700 OHMS 10% 1/2 W
R449	423748		VARIABLE, 10,000 OHMS
R450	502310	82283-074	10,000 OHMS 10% 1/2 W
R451	502310	82283-074	10,000 OHMS 10% 1/2 W
R452	502247	82283-070	4700 OHMS 10% 1/2 W
R453	502247	82283-070	4700 OHMS 10% 1/2 W
R454	502222	82283-066	2200 OHMS 10% 1/2 W
R455	502247	82283-070	4700 OHMS 10% 1/2 W
R467	502310	82283-074	10,000 OHMS 10% 1/2 W
R468	502310	82283-074	10,000 OHMS 10% 1/2 W
R469	502233	82283-068	3300 OHMS 10% 1/2 W
R470	502310	82283-074	10,000 OHMS 10% 1/2 W
R471	502368	82283-084	68,000 OHMS 10% 1/2W
R472	502210	82283-062	1000 OHMS 10% 1/2 W
R473	502118	82283-053	180 OHMS 10% 1/2 W
R474	502118	82283-053	180 OHMS 10% 1/2 W
R475	502133	82283-056	330 OHMS 10% 1/2 W
R476	502118	82283-053	180 OHMS 10% 1/2 W
R477	502118	82283-053	180 OHMS 10% 1/2 W
R478	502110	82283-050	100 OHMS 10%, 1/2 W
S301	221694		SWITCH - PUSHBUTTON
S302	221694		SWITCH - PUSHBUTTON
S303	221694		SWITCH - PUSHBUTTON
T301	922355		TRANSFORMER - AUDIO INPUT
T401	922355		TRANSFORMER - AUDIO INPUT
XDS301	423750		SOCKET - LAMP
XDS302	423750		SOCKET - LAMP
XDS303	423750		SOCKET - LAMP
XK301	423749		SOCKET - RELAY
XK302	423749		SOCKET-RELAY
XY301	248383		SOCKET - CRYSTAL
Y301	248382		CRYSTAL - 76,000 KHZ

Symbol	Stock No.	Drawing No.	Description
MECHANICAL			
	248370 246413 248372		PAD - INTEGRATED CIRCUIT, WHITE RELAY - RETAINER INSULATOR - TRANSISTOR
			MONAURAL INPUT ADAPTER MI-560716 P/L 3720215-501 REV 2
			CAPACITORS
C201	248387		FILM, .012 MF 2% 100 V
C202	248374		FILM, .022 MF 2% 100 V
C203			NOT USED
C204	215193		CERAMIC, 330 PF 5% 500 V
C205	215198		CERAMIC, 330 PF 5% 500 V
C206			NOT USED
C207	223777		ELECTROLYTIC, 47 MF 20 V
C208	224287		CERAMIC, 270 PF 5% 500 V
C209	221678		CERAMIC, 470 PF 5% 500 V
CR201	225312		DIODE, ZENER - TYPE 1ZC10T10
CR202	225312		DIODE, ZENER - TYPE 1ZC10T10
FL201	245158		FILTER - LOW PASS, 17 KHZ
P201	248266		CONNECTOR
Q201	2N3053S		TRANSISTOR - TYPE 2N3053
Q202	2N3053S		TRANSISTOR - TYPE 2N3053
			RESISTORS - FIXED COMP UNLESS NOTED
R201	502112	82283-051	120 OHMS 10% 1/2 W
R202	502112	82283-051	120 OHMS 10% 1/2 W
R203	502156	82283-059	560 OHMS 10% 1/2 W
R204	502112	82283-051	120 OHMS 10% 1/2 W
R205	502112	82283-051	120 OHMS 10% 1/2 W
R206	502168	82283-060	680 OHMS 10% 1/2 W
R207	502310	82283-074	10,000 OHMS 10% 1/2 W
R208			NOT USED
R209	502268	82283-072	6800 OHMS 10% 1/2 W
R210	502047	82283-046	47 OHMS 10% 1/2 W
R211	502310	82283-074	10,000 OHMS 10% 1/2 W
R212	502222	82283-066	2200 OHMS 10% 1/2 W
R213	502222	82283-066	2200 OHMS 10% 1/2 W
R214	502233	82283-068	3300 OHMS 10% 1/2 W
R215	502247	82283-070	4700 OHMS 10% 1/2 W
R216	502147	82283-058	470 OHMS 10% 1/2 W
R217	502247	82283-070	4700 OHMS 10% 1/2 W
R218			NOT USED
R219	502247	82283-070	4700 OHMS 10% 1/2 W
R220	502047	82283-046	47 OHMS 10% 1/2 W
R221	502015	82283-040	15 OHMS 10% 1/2 W
R222	502247	82283-070	4700 OHMS 10% 1/2 W
R223	426240		VARIABLE, 10,000 OHMS
R224	502310	82283-074	10,000 OHMS 10% 1/2 W
R225	502310	82283-074	10,000 OHMS 10% 1/2 W
R226	502247	82283-070	4700 OHMS 10% 1/2 W
R227	502310	82283-074	10,000 OHMS 10% 1/2 W
R228	502369	82283-084	68,000 OHMS 10% 1/2 W
R229	502210	82283-062	1000 OHMS 10% 1/2 W
R230	522122	99126-054	220 OHMS 10% 2 W
R231	522122	99126-054	220 OHMS 10% 2 W
R232	502210	82283-062	1000 OHMS 10% 1/2 W
S201	430897		SWITCH - TOGGLE SPDT
T201	922355		TRANSFORMER - AUDIO

Symbol	Stock No.	Drawing No.	Description
IC201	243343		INTEGRATED CIRCUIT - TYPE CA3015
IC202	243343		INTEGRATED CIRCUIT - TYPE CA3015
XQ201	422415		SOCKET, TRANSISTOR
XQ202	422415		SOCKET, TRANSISTOR
MECHANICAL			
	248370		PAD - INTEGRATED CIRCUIT, WHITE
	248372		INSULATOR - TRANSISTOR
			BTX-1B SCA GENERATOR MI-560714
			SERIAL No. 1 through 999
			P/L 3720213-501 REV 4
			CAPACITORS
C501	223777		ELECTROLYTIC, 47 MF 10% 20 V
C502	245142		CERAMIC, .005 MF 10% 500 V
C503	223777		ELECTROLYTIC, 47 MF 10% 20 V
C504	221678		MICA, 47PF 10% 500V
C505	248385		FILM, 0.47 MF 5% 100 V
C506	238220		CERAMIC, 470 PF 500 V
C507A	228121		CERAMIC, 820 PF 500V USED ON 41 KHZ AND 67 KHZ
C507B	426865		CERAMIC, 560 PF 500V USED ON 41 KHZ
C508A	228121		CERAMIC, 820 PF 500V USED ON 41 KHZ AND 67 KHZ
C508B	426865		CERAMIC, 560 PF 500V USED ON 41 KHZ
C509	432444		CERAMIC, .01 MF 20% 500V
C510	236781		ELECTROLYTIC, 2.2 MF 10% 35 V
C511	248378		FILM, 0.1 MF 10% 100 V
C512	432444		CERAMIC, .01 MF 20% 500V
C513	245142		CERAMIC, .005 MF 10% 500 V
C514A	238220		CERAMIC, 470 PF 500 V, USED ON 67 K
C514B	218971		CERAMIC, 750 PF 500 V, USED ON 41 K
C515A	426711		MICA, 120 PF 500V USED ON 67KHZ
C515B	426227		MICA, 150 PF 500V USED ON 41KHZ
C516A	426711		MICA, 120 PF 500V USED ON 67KHZ
C516B	228121		CERAMIC, 820 PF 500V USED ON 41 KHZ 67 KHZ
C516C	228121		CERAMIC, 820 PF 500V USED ON 41 KHZ
C517A	248286		MICA, 430 PF 500 V, USED ON 67 KHZ
C517B	228121		CERAMIC, 820 PF 500V USED ON 41 KHZ
C518A	228121		CERAMIC, 820 PF 500V USED ON 41 KHZ 67 KHZ
C518B	426865		CERAMIC, 560 PF 500V USED ON 41 KHZ
C519	248378		FILM, 0.1 MF 10% 100 V
C520	245142		CERAMIC, .005 MF 10% 500 V
C521	248378		FILM, 0.1 MF 10% 100 V
C522	248378		FILM, 0.1 MF 10% 100 V
C523	248379		FILM, .047 MF 10% 100 V
C524			NOT USED
C525	237797		ELECTROLYTIC, 15 MF 10% 20 V
C526	236781		ELECTROLYTIC, 2.2 MF 10% 35 V
C527	248386		FILM, .022 MF 10% 100 V
C528	248378		FILM, 0.1 MF 10% 100 V
C529	223777		ELECTROLYTIC, 47 MF 10% 20 V
C530	236781		ELECTROLYTIC, 2.2 MF 10% 35 V
C531	248386		FILM, .022 MF 10% 100 V
C532	236781		ELECTROLYTIC, 2.2 MF 10% 35 V
C533	223777		ELECTROLYTIC, 47 MF 10% 20 V
C534	223777		ELECTROLYTIC, 47 MF 10% 20 V
C535	237797		ELECTROLYTIC, 15 MF 10% 20 V

Symbol	Stock No.	Drawing No.	Description
CR501 THRU			
CR509	242220		DIODE - TYPE 1N4154
CR510	225312		DIODE - ZENER - TYPE 1ZC10T10
CR511	218612		DIODE - TYPE 1N2069
DS501	245144		LAMP - PILOT, GREEN
DS502	245145		LAMP - PILOT, RED
1C501 THRU			
1C505	244345		INTEGRATED CIRCUIT - TYPE CA3018
L501	245146		INDUCTOR
L502	245147		INDUCTOR
P501	248266		CONNECTOR
Q501	2N3053S		TRANSISTOR - TYPE 2N3053
Q502	2N3053S		TRANSISTOR - TYPE 2N3053
			RESISTORS FIXED COMP UNLESS NOTED
R501	502122	82283-054	220 OHMS 10% 1/2 W
R502	502122	82283-054	220 OHMS 10% 1/2 W
R503	502122	82283-054	220 OHMS 10% 1/2 W
R504	502147	82283-058	470 OHMS 10% 1/2 W
R505	502122	82283-054	220 OHMS 10% 1/2 W
R506	426023		VARIABLE, 1000 OHMS
R507	502310	82283-074	10,000 OHMS 10% 1/2 W
R508	502322	82283-078	22,000 OHMS 10% 1/2 W
R509	502110	82283-050	100 OHMS 10% 1/2 W
R510	502222	82283-066	2200 OHMS 10% 1/2 W
R511	502147	82283-058	470 OHMS 10% 1/2 W
R512	502322	82283-078	22,000 OHMS 10% 1/2 W
R513	502322	82283-078	22,000 OHMS 10% 1/2 W
R514	502322	82283-078	22,000 OHMS 10% 1/2 W
R515	426023		VARIABLE, 1000 OHMS
R516	502310	82283-074	10,000 OHMS 10% 1/2 W
R517	234008		VARIABLE, 2000 OHMS
R518	502115	82283-052	150 OHMS 10% 1/2 W
R519	502210	82283-062	1000 OHMS 10% 1/2 W
R520	502315	82283-076	15,000 OHMS 10% 1/2 W
R521	502222	82283-066	2200 OHMS 10% 1/2 W
R522	502222	82283-066	2200 OHMS 10% 1/2 W
R523	502222	82283-066	2200 OHMS 10% 1/2 W
R524	502247	82283-070	4700 OHMS 10% 1/2 W
R525	502268	82283-072	6800 OHMS 10% 1/2 W
R526	502268	82283-072	6800 OHMS 10% 1/2 W
R527	502222	82283-066	2200 OHMS 10% 1/2 W
R528	502247	82283-070	4700 OHMS 10% 1/2 W
R529	502210	82283-062	1000 OHMS 10% 1/2 W
R530	502210	82283-062	1000 OHMS 10% 1/2 W
R531	502110	82283-050	100 OHMS 10% 1/2 W
R532	502347	82283-082	47,000 OHMS 10% 1/2 W
R533	502310	82283-074	10,000 OHMS 10% 1/2 W
R534	502247	82283-070	4700 OHMS 10% 1/2 W
R535	502347	82283-082	47,000 OHMS 10% 1/2 W
R536	502310	82283-074	10,000 OHMS 10% 1/2 W
R537	502412	82283-087	120,000 OHMS 10% 1/2 W
R538	502322	82283-078	22,000 OHMS 10% 1/2 W
R539	502233	82283-068	3300 OHMS 10% 1/2 W
R540	502127	82283-055	270 OHMS 10% 1/2 W
R541	502247	82283-070	4700 OHMS 10% 1/2 W
R542	502310	82283-074	10,000 OHMS 10% 1/2 W
R543	502122	82283-054	220 OHMS 10% 1/2 W
R544	502322	82283-078	22,000 OHMS 10% 1/2 W
R545	502210	82283-062	1000 OHMS 10% 1/2 W
R546	232646		VARIABLE, 5000 OHMS
R547	502322	82283-078	22,000 OHMS 10% 1/2 W
R548	502322	82283-078	22,000 OHMS 10% 1/2 W
R549	502122	82283-054	220 OHMS 10% 1/2 W
R550	502222	82283-066	2200 OHMS 10% 1/2 W
R551	502322	82283-078	22,000 OHMS 10% 1/2 W
R552	502347	82283-082	47,000 OHMS 10% 1/2 W
R553	502233	82283-068	3300 OHMS 10% 1/2 W
R554	502110	82283-050	100 OHMS 10% 1/2 W

Symbol	Stock No.	Drawing No.	Description
R555	502233	82283-068	3300 OHMS 10% 1/2 W
R556	502122	82283-054	220 OHMS 10% 1/2 W
R557	502247	82283-070	4700 OHMS 10% 1/2 W
R558	232646		VARIABLE, 5000 OHMS
R559	502410	82283-086	100,000 OHMS 10% 1/2 W
R560	502422	82283-090	220,000 OHMS 10% 1/2 W
R561	502222	82283-066	2200 OHMS 10% 1/2 W
R562	502247	82283-070	4700 OHMS 10% 1/2 W
R563	502368	82283-084	68,000 OHMS 10% 1/2 W
R564	502310	82283-074	10,000 OHMS 10% 1/2 W
R565	502222	82283-066	2200 OHMS 10% 1/2 W
R566	502110	82283-050	100 OHMS 10% 1/2 W
R567	502322	82283-078	22,000 OHMS 10% 1/2 W
R568	502347	82283-082	47,000 OHMS 10% 1/2 W
R569	502247	82283-070	4700 OHMS 10% 1/2 W
R570	502147	82283-058	470 OHMS 10% 1/2 W
R571	502122	82283-054	220 OHMS 10% 1/2 W
R572	502310	82283-074	10,000 OHMS 10% 1/2 W
R573	502222	82283-066	2200 OHMS 10% 1/2 W
R574	502222	82283-066	2200 OHMS 10% 1/2 W
R575	502110	82283-050	100 OHMS 10% 1/2 W
R576	502310	82283-074	10,000 OHMS 10% 1/2 W
R577	502310	82283-074	10,000 OHMS 10% 1/2 W
R578	502222	82283-066	2200 OHMS 10% 1/2 W
R579	502222	82283-066	2200 OHMS 10% 1/2 W
R580	502222	82283-066	2200 OHMS 10% 1/2 W
R581	502310	82283-074	10,000 OHMS 10% 1/2 W
R582	502310	82283-074	10,000 OHMS 10% 1/2 W
R583	502127	82283-055	270 OHMS 10% 1/2 W
R584	502127	82283-055	270 OHMS 10% 1/2 W
R585	502047	82283-046	47 OHMS 10% 1/2 W
R586	502110	99126-050	100 OHMS 10% 2 W
R587	245157		VARIABLE, 100,000 OHMS
S501	430897		SWITCH = TOGGLE
T501	245149		TRANSFORMER
XDS501	248262		SOCKET = LAMP
XDS502	248262		SOCKET = LAMP
MECHANICAL			MISCELLANEOUS
	248370		PAD = INTEGRATED CIRCUIT, WHITE
	248377		PAD = TRANSISTOR
			BTX-1B SCA GENERATOR MI-560714
			SERIAL No. 1000 and up
			P/L 3720213-502 REV 4
			CAPACITORS
C501	223777		ELECTROLYTIC, 47 MF 10% 20 V
C502	245142		CERAMIC, .005 MF 10% 500 V
C503	223777		ELECTROLYTIC, 47 MF 10% 20 V
C504	221678		MICA, 47PF 10% 500V
C505	249954		TANTALUM, 22UF 20V
C506	249954		TANTALUM, 22UF 20V
C507A	426865		CERAMIC, 560 PF 500V USED ON 67 KHZ
C507B	215198		CERAMIC, 330PF 500V USED ON 41 KHZ
C507C	228121		CERAMIC, 820 PF 500V USED ON 41 KHZ
C508A	426865		CERAMIC, 560 PF 500V USED ON 67 KHZ
C508B	215198		CERAMIC, 330PF 500V USED ON 41 KHZ
C508C	228121		CERAMIC, 820 PF 500V USED ON 41 KHZ
C509	432444		CERAMIC, .01 MF 20% 500V
C510	236781		ELECTROLYTIC, 2.2 MF 10% 35 V
C511	248378		FILM, 0.1 MF 10% 100 V
C512	423731		FILM, .01UF 10% 100V
C513	245142		CERAMIC, .005 MF 10% 500 V
C514A	238220		CERAMIC, 470PF 10% 500V=USED ON 67K
C514B	218971		CERAMIC, 750PF 10% 500V=USED ON 41K

Symbol	Stock No.	Drawing No.	Description
C515A	426711		CERAMIC, 120 PF 500V USED ON 67 KHZ
C515B	426227		CERAMIC, 150 PF 500V USED ON 41 KHZ
C516A	228121		CERAMIC, 820 PF 500V USED ON 67 KHZ
C516B	426711		CERAMIC, 120PF 500V USED ON 67 KHZ
C516C	228121		CERAMIC, 820 PF 500V USED ON 41 KHZ
C516D	228121		CERAMIC, 820 PF 500V USED ON 41 KHZ
C517A	248286		CERAMIC, 430PF 10% 500V-USED ON 67K
C517B	228121		CERAMIC, 820 PF 500V USED ON 41 KHZ
C518A	228121		CERAMIC, 820 PF 500V USED ON 67 KHZ
C518B	426865		CERAMIC, 560 PF 500V USED ON 41 KHZ
C518C	228121		CERAMIC, 820 PF 500V USED ON 41 KHZ
C519	248378		FILM, 0.1 MF 10% 100 V
C520	245142		CERAMIC, .005 MF 10% 500 V
C521	248378		FILM, 0.1 MF 10% 100 V
C522	248378		FILM, 0.1 MF 10% 100 V
C523	248379		FILM, .047 MF 10% 100 V
C524			NOT USED
C525	237797		ELECTROLYTIC, 15 MF 10% 20 V
C526	236781		ELECTROLYTIC, 2.2 MF 10% 35 V
C527	248386		FILM, .022 MF 10% 100 V
C528	248378		FILM, 0.1 MF 10% 100 V
C529	223777		ELECTROLYTIC, 47 MF 10% 20 V
C530	236781		ELECTROLYTIC, 2.2 MF 10% 35 V
C531	248386		FILM, .022 MF 10% 100 V
C532	236781		ELECTROLYTIC, 2.2 MF 10% 35 V
C533	223777		ELECTROLYTIC, 47 MF 10% 20 V
C534	223777		ELECTROLYTIC, 47 MF 10% 20 V
C535	237797		ELECTROLYTIC, 15 MF 10% 20 V
C536	227444		CERAMIC, .1UF 25V
C537	240846		CERAMIC, .001UF 1000V
CR505 THRU			
CR509	242220		DIODE = TYPE 1N4154
CR510	225312		DIODE = ZENER = TYPE 1ZC10T10
CR511	218612		DIODE = TYPE 1N2069
D5501	245144		LAMP = PILOT, GREEN
D5502	245145		LAMP = PILOT, RED
IC501 THRU			
IC505	244345		INTEGRATED CIRCUIT = TYPE CA3018
L501	245146		INDUCTOR
L502	245147		INDUCTOR
P501	248266		CONNECTOR
Q501	2N3053S		TRANSISTOR = TYPE 2N3053
Q502	2N3053S		TRANSISTOR = TYPE 2N3053
			RESISTORS FIXED COMP UNLESS NOTED
R501	502122	82283-054	220 OHMS 10% 1/2 W
R502	502122	82283-054	220 OHMS 10% 1/2 W
R503	502122	82283-054	220 OHMS 10% 1/2 W
R504	502147	82283-058	470 OHMS 10% 1/2 W
R505	502122	82283-054	220 OHMS 10% 1/2 W
R506	426023		VARIABLE, 1000 OHMS
R507	502310	82283-074	10,000 OHMS 10% 1/2 W
R508	502322	82283-078	22,000 OHMS 10% 1/2 W
R509	502133	82283-056	330 OHMS 10% 1/2W
R510	502222	82283-066	2200 OHMS 10% 1/2 W
R511	502139	82283-057	390 OHMS 10% 1/2W
R512	502327	82283-079	27K OHMS 10% 1/2W
R513	502222	82283-066	2200 OHMS 10% 1/2W
R514	502247	82283-070	4700 OHMS 10% 1/2W
R515	426023		VARIABLE, 1000 OHMS
R516	502247	82283-070	4700 OHMS 10% 1/2W
R517	234008		VARIABLE, 2000 OHMS
R518	502315	82283-076	15K OHMS 10% 1/2W
R519	502215	82283-064	1500 OHMS 10% 1/2W
R520	423732		THERMISTOR, 5K OHMS
R521	502310	82283-074	10K OHMS 10% 1/2W
R522	502247	82283-070	4700 OHMS 10% 1/2W
R525	502239	82283-069	3900 OHMS 10% 1/2W

Symbol	Stock No.	Drawing No.	Description
R526	502239	82283-069	3900 OHMS 10% 1/2W
R529	502222	82283-066	2200 OHMS 10% 1/2W
R530	502222	82283-066	2200 OHMS 10% 1/2W
R531	502110	82283-050	100 OHMS 10% 1/2 W
R532	502347	82283-082	47,000 OHMS 10% 1/2 W
R533	502310	82283-074	10,000 OHMS 10% 1/2 W
R534	502247	82283-070	4700 OHMS 10% 1/2 W
R535	502347	82283-082	47,000 OHMS 10% 1/2 W
R536	502310	82283-074	10,000 OHMS 10% 1/2 W
R537	502412	82283-087	120,000 OHMS 10% 1/2 W
R538	502322	82283-078	22,000 OHMS 10% 1/2 W
R539	502233	82283-068	3300 OHMS 10% 1/2 W
R540	502122	82283-054	220 OHMS 10% 1/2 W
R541	502247	82283-070	4700 OHMS 10% 1/2 W
R542	502310	82283-074	10,000 OHMS 10% 1/2 W
R543	502122	82283-054	220 OHMS 10% 1/2 W
R544	502322	82283-078	22,000 OHMS 10% 1/2 W
R545	502210	82283-062	1000 OHMS 10% 1/2 W
R546	232646		VARIABLE 5000 OHMS
R547	502322	82283-078	22,000 OHMS 10% 1/2 W
R548	502322	82283-078	22,000 OHMS 10% 1/2 W
R549	502122	82283-054	220 OHMS 10% 1/2 W
R550	502222	82283-066	2200 OHMS 10% 1/2 W
R551	502322	82283-078	22,000 OHMS 10% 1/2 W
R552	502347	82283-082	47,000 OHMS 10% 1/2 W
R553	502233	82283-068	3300 OHMS 10% 1/2 W
R554	502110	82283-050	100 OHMS 10% 1/2 W
R555	502233	82283-068	3300 OHMS 10% 1/2 W
R556	502122	82283-054	220 OHMS 10% 1/2 W
R557	502247	82283-070	4700 OHMS 10% 1/2 W
R558	232646		VARIABLE, 5000 OHMS
R559	502410	82283-086	100,000 OHMS 10% 1/2 W
R560	502422	82283-090	220,000 OHMS 10% 1/2W
R561	502222	82283-066	2200 OHMS 10% 1/2 W
R562	502410	82283-086	100,000 OHMS 10% 1/2 W
R563	502368	82283-084	68,000 OHMS 10% 1/2 W
R564	502310	82283-074	10,000 OHMS 10% 1/2 W
R565	502222	82283-066	2200 OHMS 10% 1/2 W
R566	502110	82283-050	100 OHMS 10% 1/2 W
R567	502322	82283-078	22,000 OHMS 10% 1/2 W
R568	502347	82283-082	47,000 OHMS 10% 1/2 W
R569	502247	82283-070	4700 OHMS 10% 1/2 W
R570	502147	82283-058	470 OHMS 10% 1/2 W
R571	502122	82283-054	220 OHMS 10% 1/2 W
R572	502310	82283-074	10,000 OHMS 10% 1/2 W
R573	502222	82283-066	2200 OHMS 10% 1/2 W
R574	502222	82283-066	2200 OHMS 10% 1/2 W
R575	502110	82283-050	100 OHMS 10% 1/2 W
R576	502310	82283-074	10,000 OHMS 10% 1/2 W
R577	502310	82283-074	10,000 OHMS 10% 1/2 W
R578	502222	82283-066	2200 OHMS 10% 1/2 W
R579	502222	82283-066	2200 OHMS 10% 1/2 W
R580	502222	82283-066	2200 OHMS 10% 1/2 W
R581	502247	82283-070	4700 OHMS 10% 1/2W
R582	502247	82283-070	4700 OHMS 10% 1/2W
R583	502127	82283-055	270 OHMS 10% 1/2 W
R584	502127	82283-055	270 OHMS 10% 1/2 W
R585	502047	82283-046	47 OHMS 10% 1/2 W
R586	502068	82283-048	68 OHMS 10% 1/2W
R587	245157		VARIABLE, 100,000 OHMS
S501	430897		SWITCH - TOGGLE
T501	245149		TRANSFORMER
XDS501	423750		SOCKET=LAMP
XDS502	423750		SOCKET=LAMP
MECHANICAL			
	248370		PAD - INTEGRATED CIRCUIT, WHITE
	248377		PAD - TRANSISTOR
	423733		FILTER=LOW PASS

Symbol	Stock No.	Drawing No.	Description
			BTE-15A MAIN FRAME MI-560710 P/L 3720208-501 REV 3
			CAPACITORS
C101 THRU			
C104	436896		2600 UF 50V ELECT (WITH CLAMP)
C105	432444		CERAMIC, .01 MF 20% 600V
C106	432444		CERAMIC, .01 MF 20% 600V
C107	432444		CERAMIC, .01 MF 20% 600V
C108	223102		FILTER, 0.1 MF 75 V
C109	427443		FILTER, 250 MF 50V
C110 THRU			
C113	434244		CERAMIC, .01 MF 20% 600V
C115 THRU			
C117	434244		CERAMIC, .01 MF 20% 600V
C118	236781		TANTALUM, 2.2 MF 10% 35 V
C119	236781		TANTALUM, 2.2 MF 10% 35 V
C120	221678		MICA, 47 PF 5% 500 V
C121	237797		TANTALUM, 15 MF 10% 20 V
C122	237797		TANTALUM, 15 MF 10% 20 V
C123	237797		TANTALUM, 15 MF 10% 20 V
C124	237802		TANTALUM, 6.8 MF 10% 35 V
C125	223777		TANTALUM, 47 MF 10% 20 V
C126 THRU			
C130	427443		FILTER, 250 MF 50V
CB101	248261		CIRCUIT BREAKER - 2 AMP, 240 V
CR101	248260		DIODE, ZENER = TYPE 1N1361
CR102 THRU			
CR105	245126		DIODE = TYPE 1N1344A
CR106	430999		DIODE, ZENER = TYPE 1ZS10A, 1N4704A
CR107	245128		DIODE, ZENER = TYPE 1ZC16T10
CR108 THRU			
CR111	234552		DIODE = TYPE 10D2
CR112	245128		DIODE, ZENER = TYPE 1ZC16T10
CR113	234552		DIODE = TYPE 10D2
CR114	234552		DIODE = TYPE 10D2
CR115	425621		DIODE, ZENER = TYPE 1ZC4.3T10
CR116	242220		DIODE = TYPE 1N4154
CR117	419628		DIODE = TYPE 1N4751A ZENER
DS101	248263		PILOT LAMP
F101	243680		FUSE, AGC 2.5A 250V
IC101	244345		INTEGRATED CIRCUIT = TYPE CA3018
J101	245135		CONNECTOR = 8 TERMINAL
J102	221181		CONNECTOR = 12 TERMINAL
J103	54472		CONNECTOR = POWER, MALE BASE
J104	245138		CONNECTOR = SCA NO. 1
J105	245138		CONNECTOR = SCA NO. 2
J106	245138		CONNECTOR = STEREO
J107	245138		CONNECTOR = FM EXCITER
J108	223973		CONNECTOR = BNC, WIDE BAND
J109	211510		CONNECTOR = LEFT IN
J110	211510		CONNECTOR = RIGHT IN
J111	223973		CONNECTOR = BNC, TELEMETRY
J112	211510		CONNECTOR = SCA, 2 IN
J113	211510		CONNECTOR = SCA, 1 IN
K101	240537		RELAY = REMOTE POWER, 220 VAC
K102	225358		RELAY = AFC, UNLOCK 24 V DC

Symbol	Stock No.	Drawing No.	Description
L101	245132		CHOKE = RF, 2.4 UH
L102	245132		CHOKE = RF, 2.4 UH
M101	245133		METER = 0-50 UA
M102	245134		METER = AUDIO, 0-200 UA
Q101	232359		TRANSISTOR = TYPE 2N3055
Q102	2N5293		TRANSISTOR = TYPE 2N5293
Q103	2N5293		TRANSISTOR = TYPE 2N5293
Q104	241250		TRANSISTOR = TYPE 2N3740
Q105	2N5293		TRANSISTOR = TYPE 2N5293
Q106	2N3053S		TRANSISTOR = TYPE 2N3053
Q107	2N3053S		TRANSISTOR = TYPE 2N3053
Q108	236285		TRANSISTOR = TYPE 2N3565
Q109	2N3053S		TRANSISTOR = TYPE 2N3053
			RESISTORS FIXED COMP UNLESS NOTED
R101	215840		VARIABLE, 12 OHMS 50 W
R102	502510	82283-098	1 MEGOHM 10% 1/2 W
R103	502147	82283-058	470 OHMS 10% 1/2 W
R104	502215	82283-064	1500 OHMS 10% 1/2 W
R105	502218	82283-065	1800 OHMS 10% 1/2 W
R106	502310	82283-074	10,000 OHMS 10% 1/2 W
R107	426240		VARIABLE, 10,000 OHMS
R108	502315	82283-076	15,000 OHMS 10% 1/2 W
R109	502122	82283-054	220 OHMS 10% 1/2 W
R110	502147	82283-058	470 OHMS 10% 1/2 W
R111	522147	99126-058	470 OHMS 10% 2 W
R112	502427	82283-091	270,000 OHMS 10% 1/2 W
R113	502322	82283-078	22,000 OHMS 10% 1/2 W
R114	502310	82283-074	10,000 OHMS 10% 1/2 W
R115	502210	82283-062	1000 OHMS 10% 1/2 W
R116	502356	82283-083	56,000 OHMS 10% 1/2 W
R117	502310	82283-074	10,000 OHMS 10% 1/2 W
R118	502222	82283-066	2200 OHMS 10% 1/2 W
R119	502147	82283-058	470 OHMS 10% 1/2 W
R120	502110	82283-050	100 OHMS 10% 1/2 W
R121	502122	82283-054	220 OHMS 10% 1/2 W
R122	502222	82283-066	2200 OHMS 10% 1/2 W
R123	502247	82283-070	4700 OHMS 10% 1/2 W
R124	502247	82283-070	4700 OHMS 10% 1/2 W
R125	502010	82283-038	10 OHMS 10% 1/2 W
R126	502310	82283-074	10,000 OHMS 10% 1/2 W
R127	502215	82283-064	1500 OHMS 10% 1/2 W
R128	502333	82283-080	33,000 OHMS 10% 1/2 W
R129	431112		VARIABLE, 200 OHMS
R130			
THRU R136	426240		VARIABLE, 10,000 OHMS
R137	502210	82283-062	1000 OHMS 10% 1/2 W
S101	245139		SWITCH - ROTARY
S102	245140		SWITCH - ROTARY
S103	225745		SWITCH - SPST
T101	245141		TRANSFORMER = POWER
XDS101	423750		LAMP SOCKET
XQ101	248368		MOUNTING KIT=TRANSISTOR
XQ102			
THRU XQ105	248369		MOUNTING KIT=TRANSISTOR
MECHANICAL			
	248372		INSULATOR = TRANSISTOR
	50367		SOCKET = OCTAL
	48894		FUSE POST HOLDER
	248370		PAO = INTEGRATED CIRCUIT, WHITE
	423745		KNOB=METAL SKIRTED
	9915		SOCKET

Symbol	Stock No.	Drawing No.	Description
SET OF CONNECTOR PLUGS MI-560734			
1	921359	1510013-101	UG-88C/U (CONNECTS J2, J108 & J111)
2	211509	481799-001	AUDIO (CONNECTS J109, J110, J112 & J113)
3	32661	878243-001	2 CONDUCTOR (EXCITER POWER, CONNECTS TO J103)
4	55808	727969-008	8 TERMINAL FEMALE (CONNECTS TO J101)
5	54254	727969-018	12 TERMINAL FEMALE CONNECTS TO J102
6	101966	3722886-007	DUMMY PLUG (SUBSTITUTE FOR EXCITER REMOTE POWER RELAY K101)
	424269	8544669-001	CONNECTOR, COAXIAL (ADAPTER BNC-N)
	243867		1500 OHM 1/2W COMP
	426159	8528981-001	DIRECTIONAL COUPLER
MODULE EXTENDER MI-560719			
1		3456737-	MODULE EXTENDER
5	248266		CONNECTOR
6	245138		CONNECTOR
RECOMMENDED SPARE RF TRANSISTORS MI-560718			
1	247994		TRANSISTOR - TYPE 2N4427
2	2N3866		TRANSISTOR - TYPE 2N3866
3	2N4440		TRANSISTOR - TYPE 2N4440
4	2N5102		TRANSISTOR - TYPE 2N5102

SUGGESTED EQUIPMENT SPARES

BTE-15A FM EXCITER

Description	Symbol	Quantity	Stock No.
Capacitor, Electrolytic - 0.1 uF 35V	C50, C51	1	247837
Capacitor, Electrolytic - 0.22 uF 35V	C9, C49	1	423739
Capacitor, Electrolytic - 1.0 uF 35V	C38, C84	1	242034
Capacitor, Electrolytic - 2.2 uF 20V	C8, C94, C98	1	423736
Capacitor, Electrolytic - 22 uF 20V	C45, C47	1	245163
Capacitor, Electrolytic - 100 uF 20V	C31	1	245168
Capacitor, Electrolytic - 150 uF 15V	C19	1	248251
Capacitor, Electrolytic - 1500 uF 25V	C25	1	423734
Oven, Crystal - MI-560717A (Crystal not included)	12	1	248376
One Each of All Integrated Circuits, Transistors and Diodes (1N3518, 1N4151, 1N4154, 1ZC30T5, 10D2, MV840, 2N3640, 2N3866, 2N4037, 2N4427, 2N4440, 2N5102, 2N5293, CA3018, CA3028, MC825P, MC890P, MC1013P and MC1027P)	MI-560730	1	RO391

SUGGESTED EQUIPMENT SPARES (Continued)

BTS-1B STEREO GENERATOR

Description	Symbol	Quantity	Stock No.
Capacitor, Electrolytic - 15 uF 20V	C318, C418, C419	1	237797
Capacitor, Electrolytic - 47 uF 20V	C307, C309, C310, C320, C322, C325, C420	1	223777
Lamp, Left - 28V, 40 mA	DS301	3	245152
Lamp, Stereo - 28V, 40 mA	DS302	3	245153
Lamp, Right - 28V, 40 mA	DS303	3	245154
Resistor, Variable - 50 ohms	R332	1	423747
Resistor, Variable - 1000 ohms	R322, R356	1	261451
Resistor, Variable - 1000 ohms	R357, R366	1	423746
Resistor, Variable - 2000 ohms	R334	1	234008
Resistor, Variable - 10,000 ohms	R329, R349, R449	1	243748
Resistor, Variable - 100,000 ohms 10% 1/2 W	R359	1	245157
Crystal - 76.000 kHz	Y301	1	248382
One Each of All Integrated Circuits Transistors and Diodes (1N4154, 1ZC10T10, 10D2, 2N3053, 2N4037, CA3015, CA3018, CA3028 and MC890P)	MI-560731	1	RO392

MONAURAL INPUT ADAPTER

Capacitor, Electrolytic - 47 uF, 20V	C207	1	223777
Resistor, Variable, 10,000 ohms	R223	1	259322
One Each of All Integrated Circuits, Transistors and Diodes (1ZC10T10, 2N3053 and CA3015)	MI-560733	1	RO394

BTE-15A MAIN FRAME

Capacitor, Electrolytic - 1600 uF, 50V	C101, C102, C103, C104	1	423779
Lamp, Pilot	DS101	3	248263
Fuse - AGC 2.5A 250V	F101	5	243680
Resistor, Variable - 12 ohms, 50 W	R101	1	215840
Resistor, Variable - 200 ohms	R129	1	258091
Resistor, Variable - 10,000 ohms	R107, R130 thru R136	1	259322
One Each of All Integrated Circuits, Transistors and Diodes (1N1344A, 1N1361, 1N4154, 1ZC4.3T10, 1ZC16T10, 1ZS10A, 10D2, 2N3053, 2N3055, 2N3565, 2N3740, 2N5293 and CA3018)	MI-560729	1	RO390

BTX-1B SCA GENERATOR

Capacitor, Electrolytic - 2.2 uF 35V	C510, C526, C530, C532	1	236781
Capacitor, Electrolytic - 15 uF 20V	C525, C535	1	237797
Capacitor, Electrolytic 47 uF 20V	C501, C503, C529, C533, C534	1	223777
Lamp, Pilot - Green	DS501	3	245144
Lamp, Pilot - Red	DS502	3	245145
Resistor, Variable - 1000 ohms	R506, R515	1	245156
Resistor, Variable - 2500 ohms	*R517	1	248264
Resistor, Variable - 10,000 ohms	**R517	1	259322
Resistor, Variable - 5,000 ohms	R546, R558	1	232646
Resistor, Variable - 100,000 ohms	R587	1	245157
One Each of Integrated Circuits Transistors and Diodes (1N2069, 1N4154, 1ZC10T10, 2N3053 and CA3018)	MI-560732	1	RO393

*Used on SCA boards serial no. 1000 and up.

**Used on SCA boards serial no. 1 through 999.

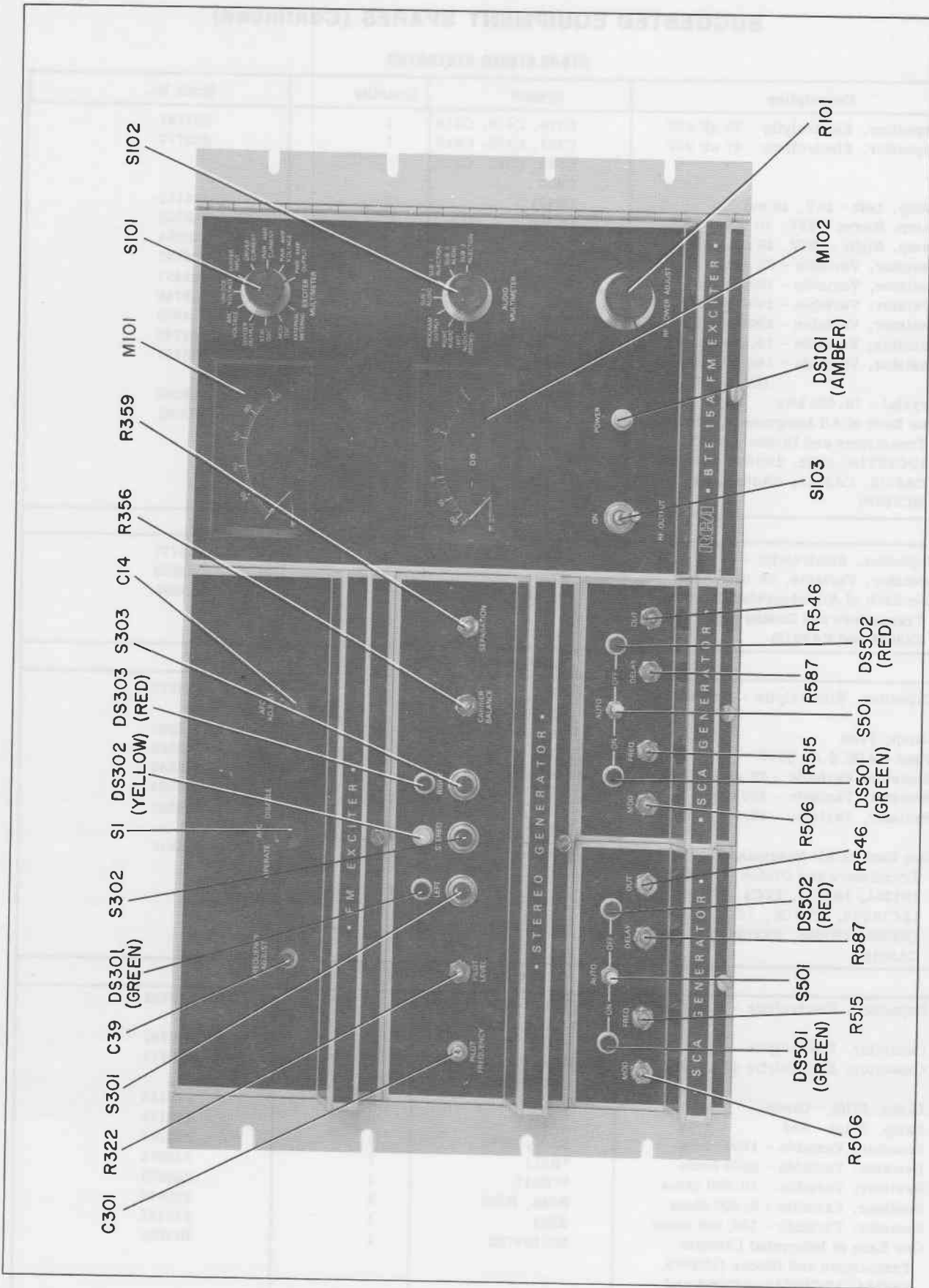

Figure 6. BTE-15A Exciter System, Front View

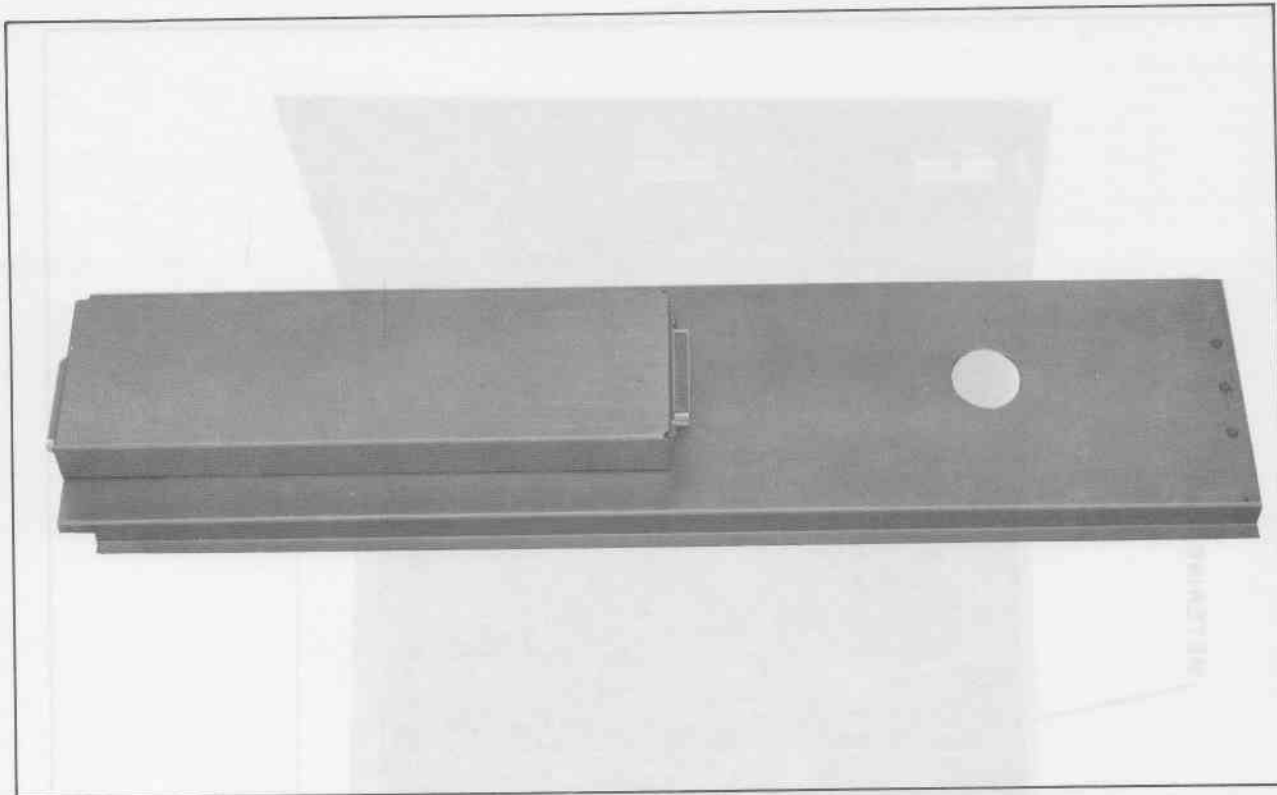

Figure 7. BTE-15A System, Module Extender

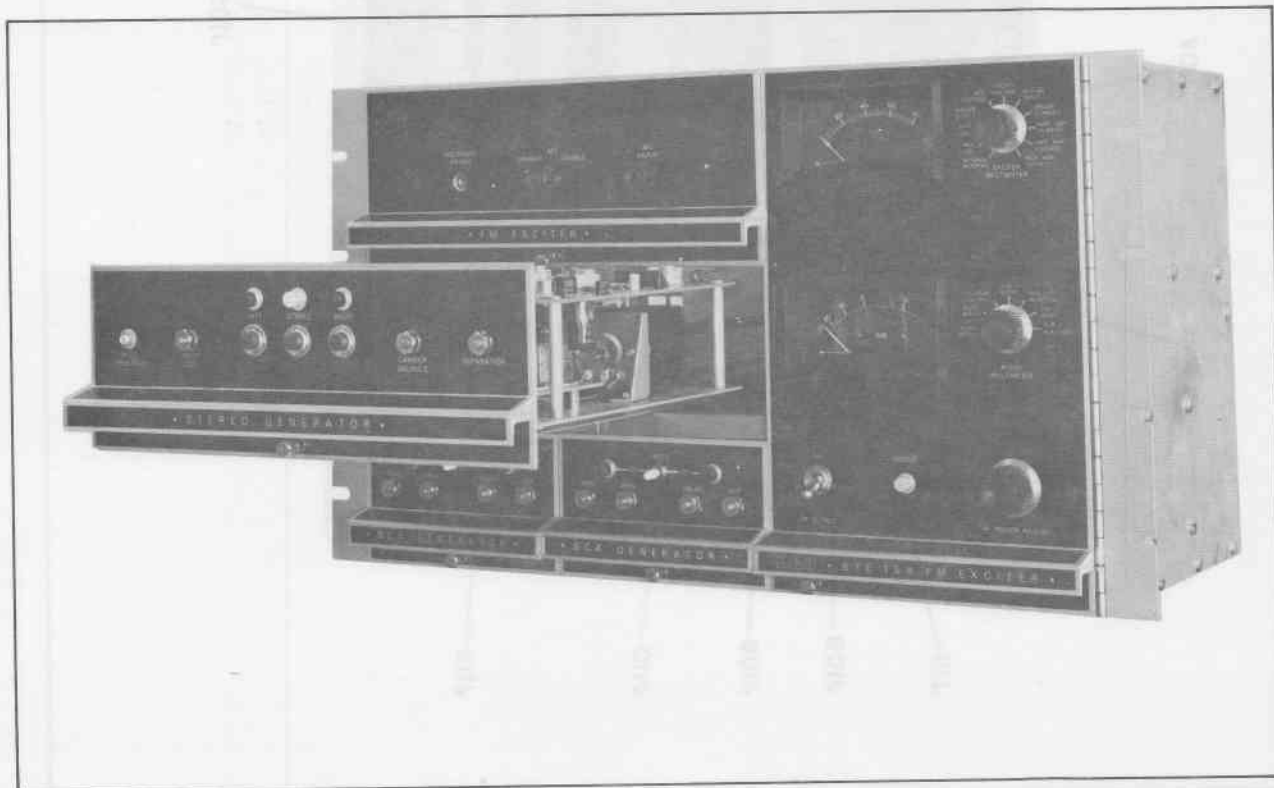

Figure 8. BTE-15A System, Module Extender Installed

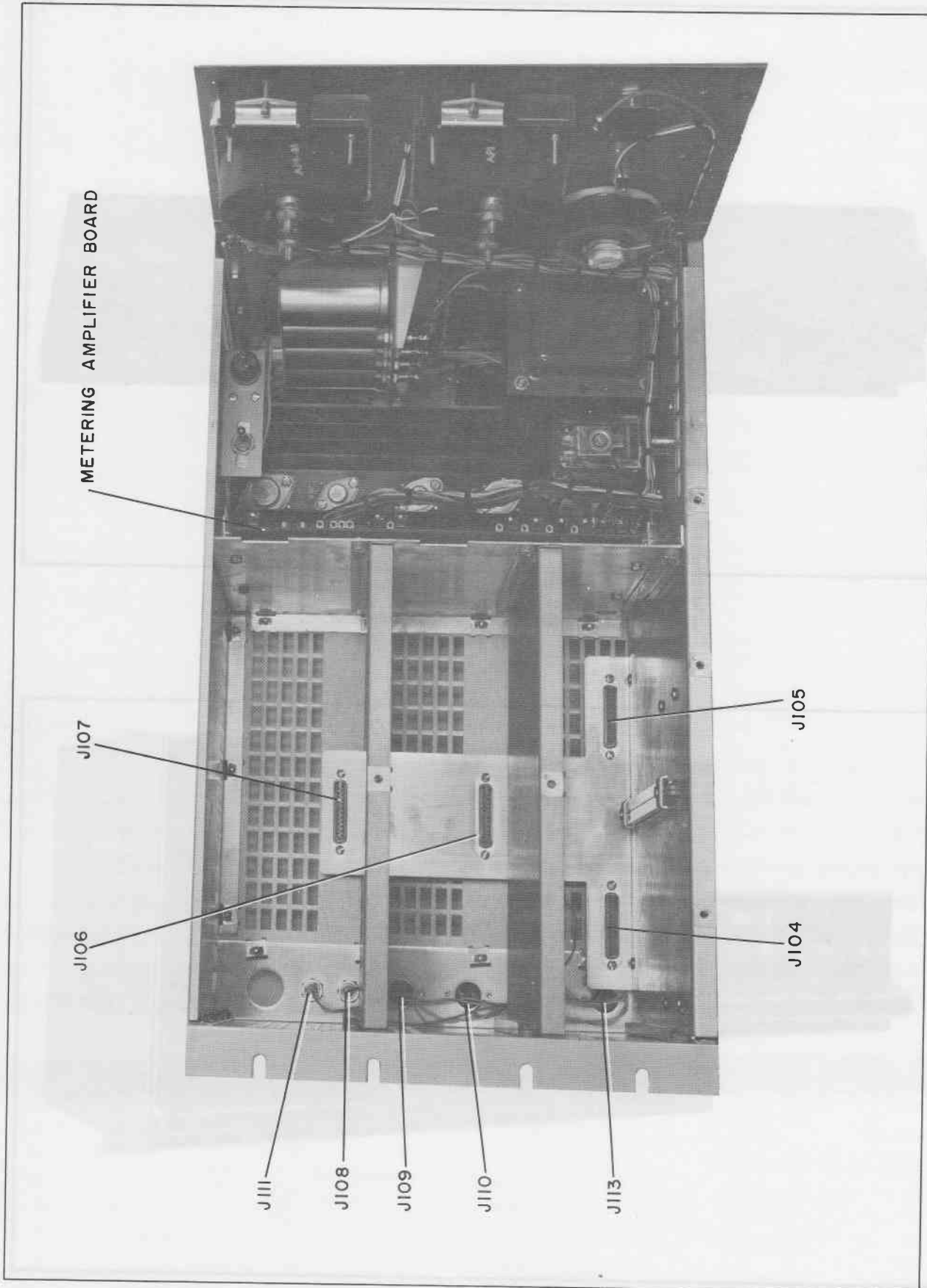

Figure 9. BTE-15A System, Modules Removed

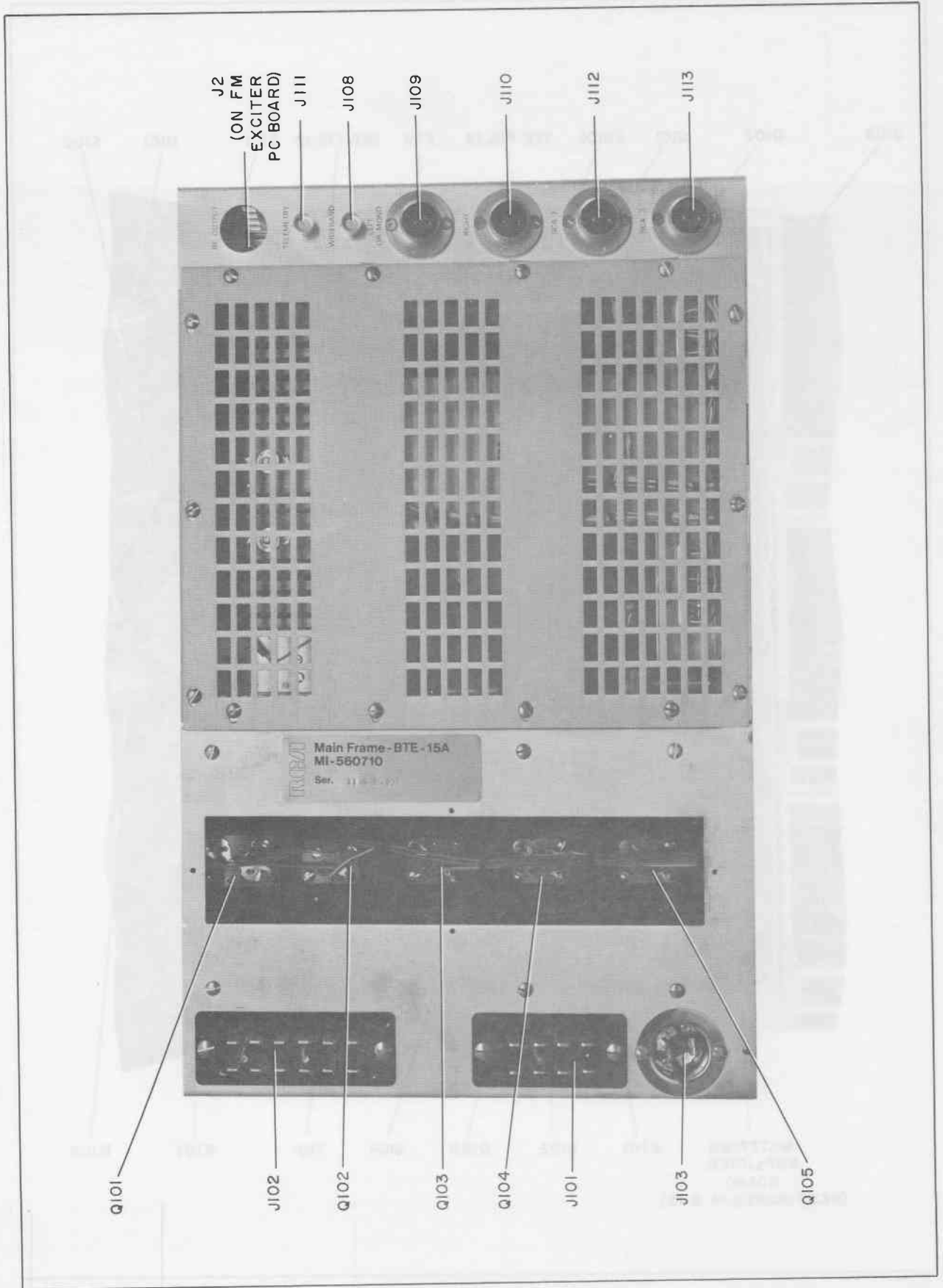

Figure 10. Main Frame, Rear View

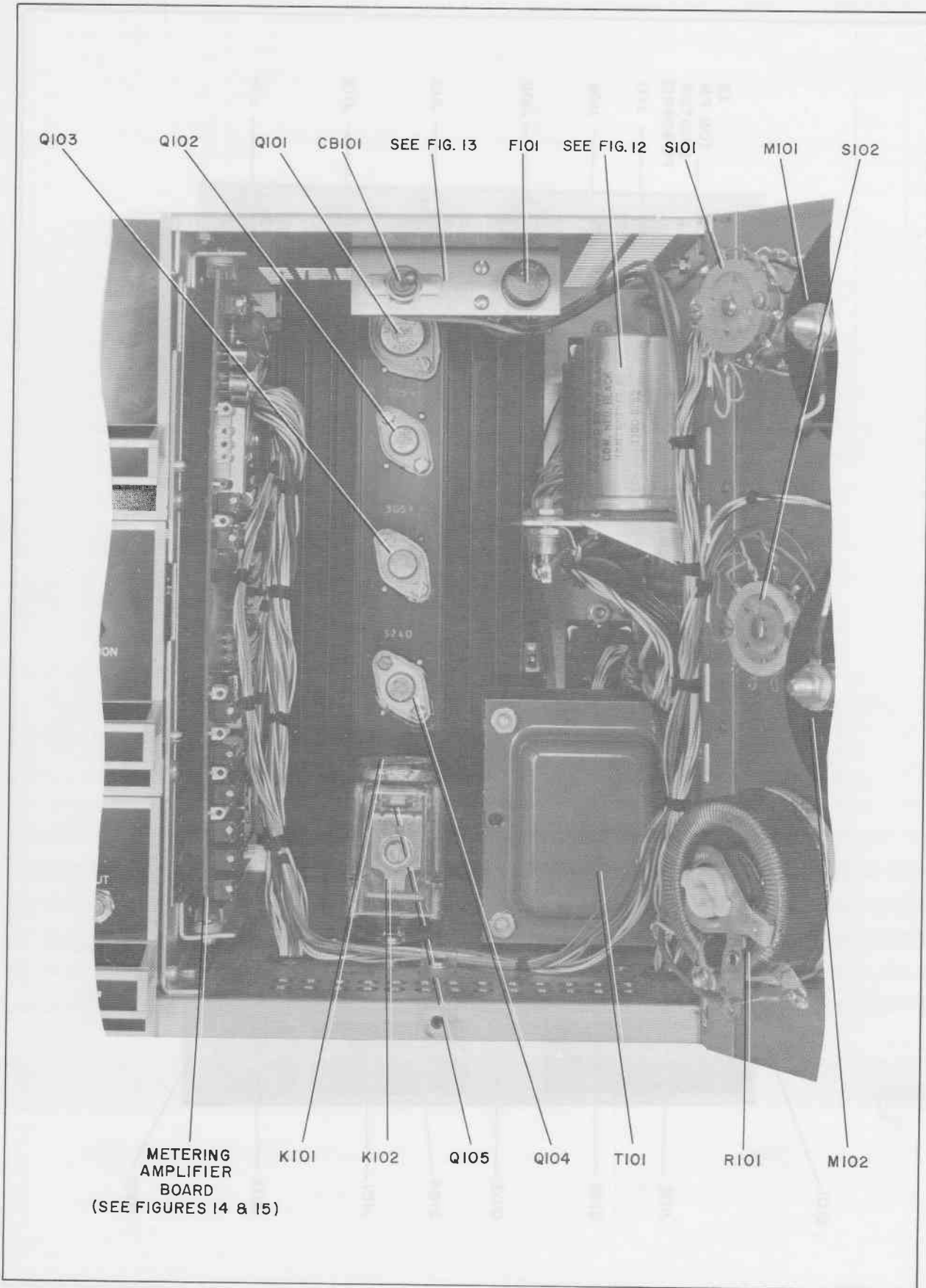

Figure 11. Main Frame, Parts Location

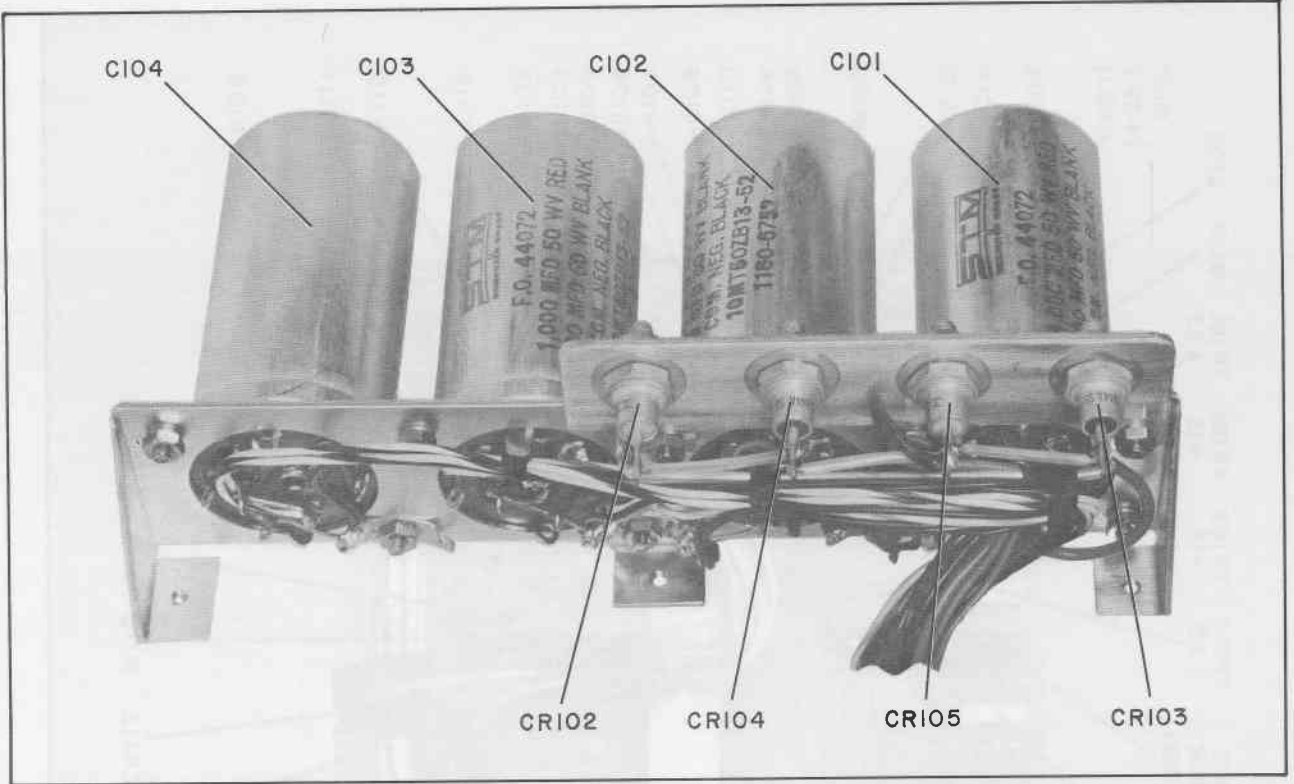

Figure 12. Main Frame, Rectifier and Filter

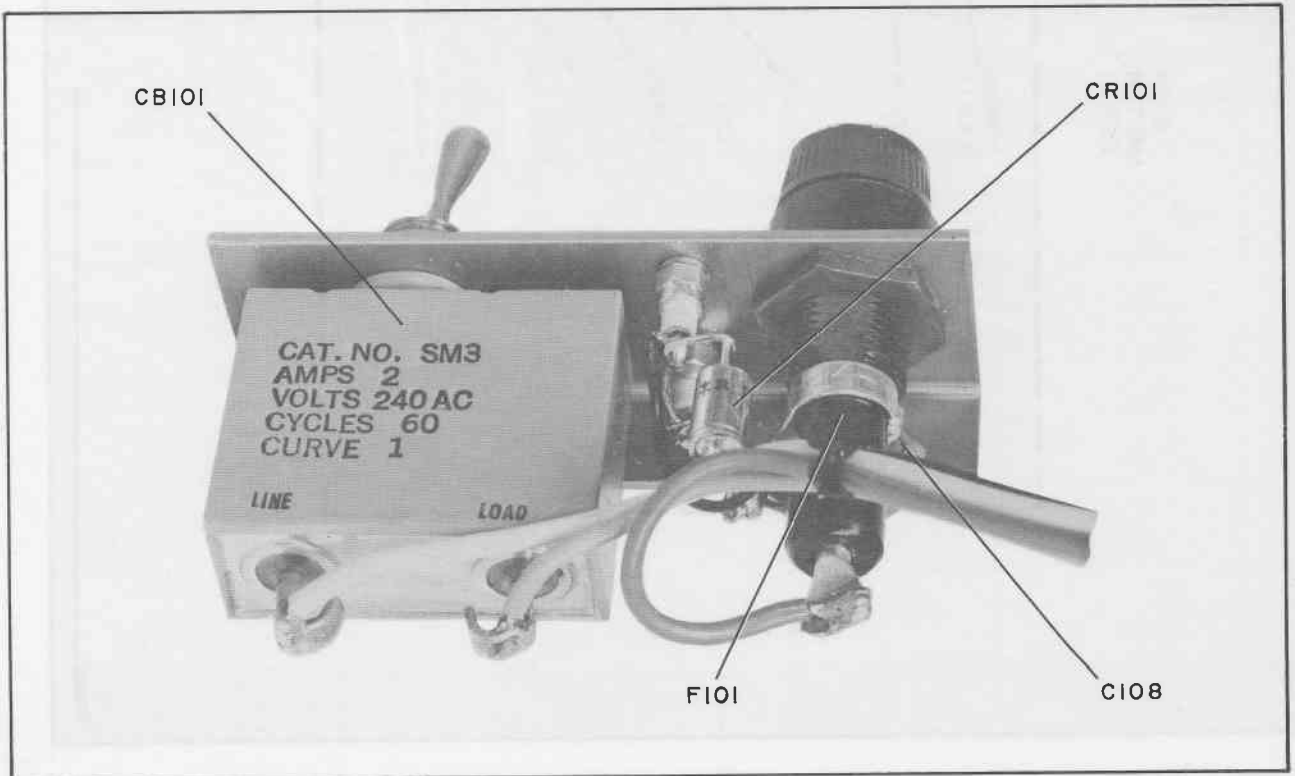
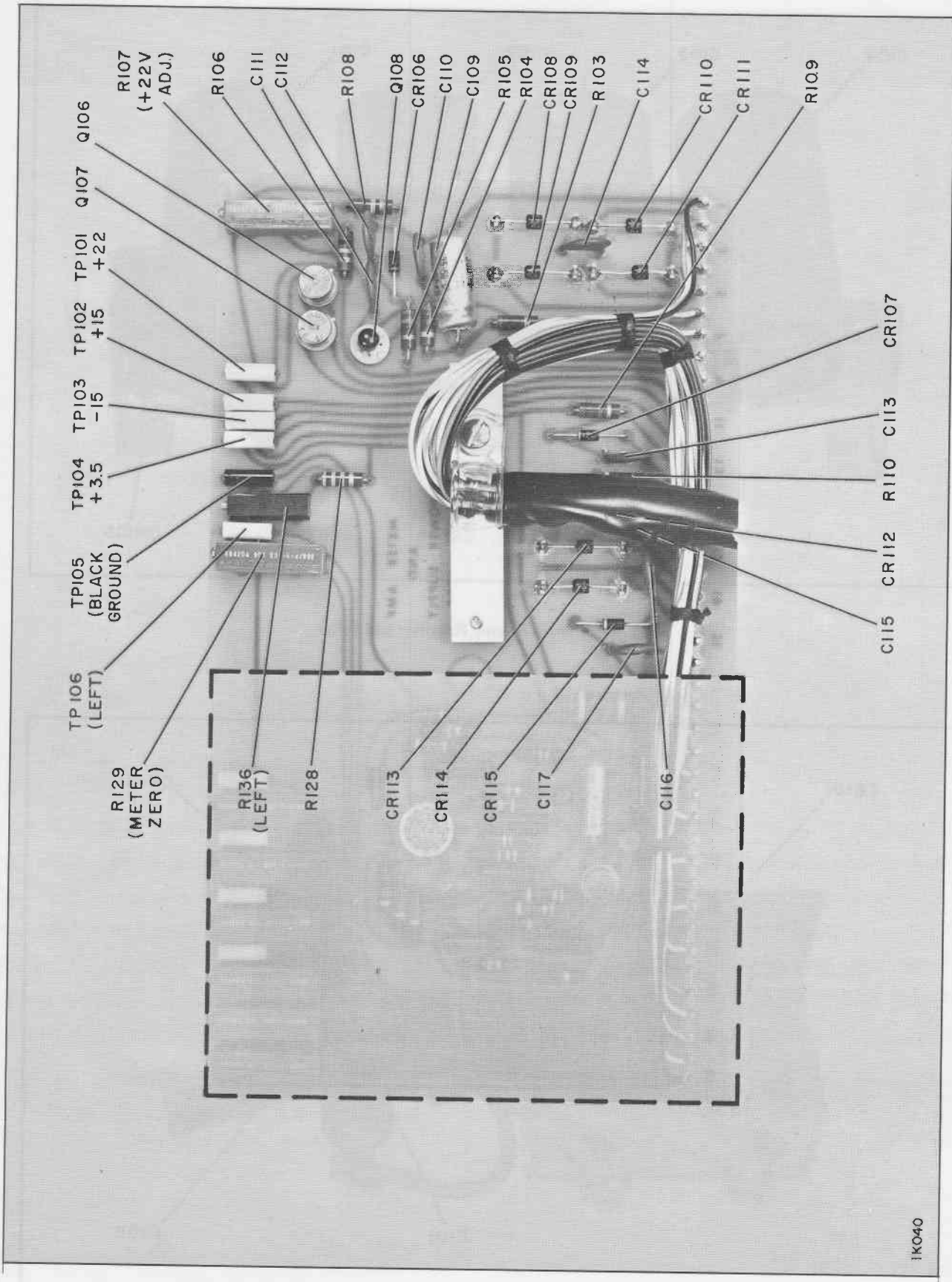
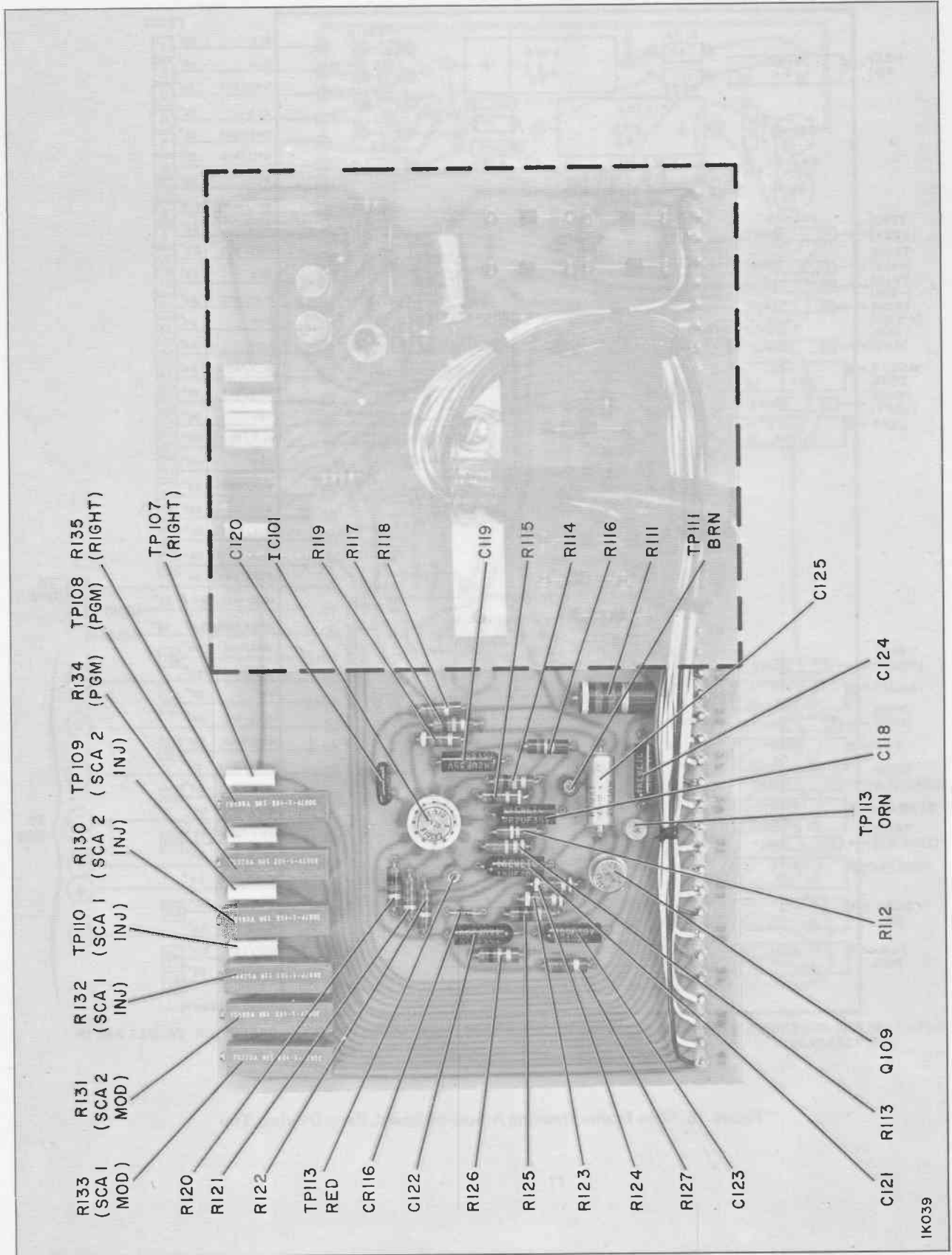

Figure 13. Main Frame, Fuse Panel



1K040

Figure 14. Main Frame Metering Amplifier Board, Parts Location



IK039

Figure 15. Main Frame Metering Amplifier Board, Parts Location

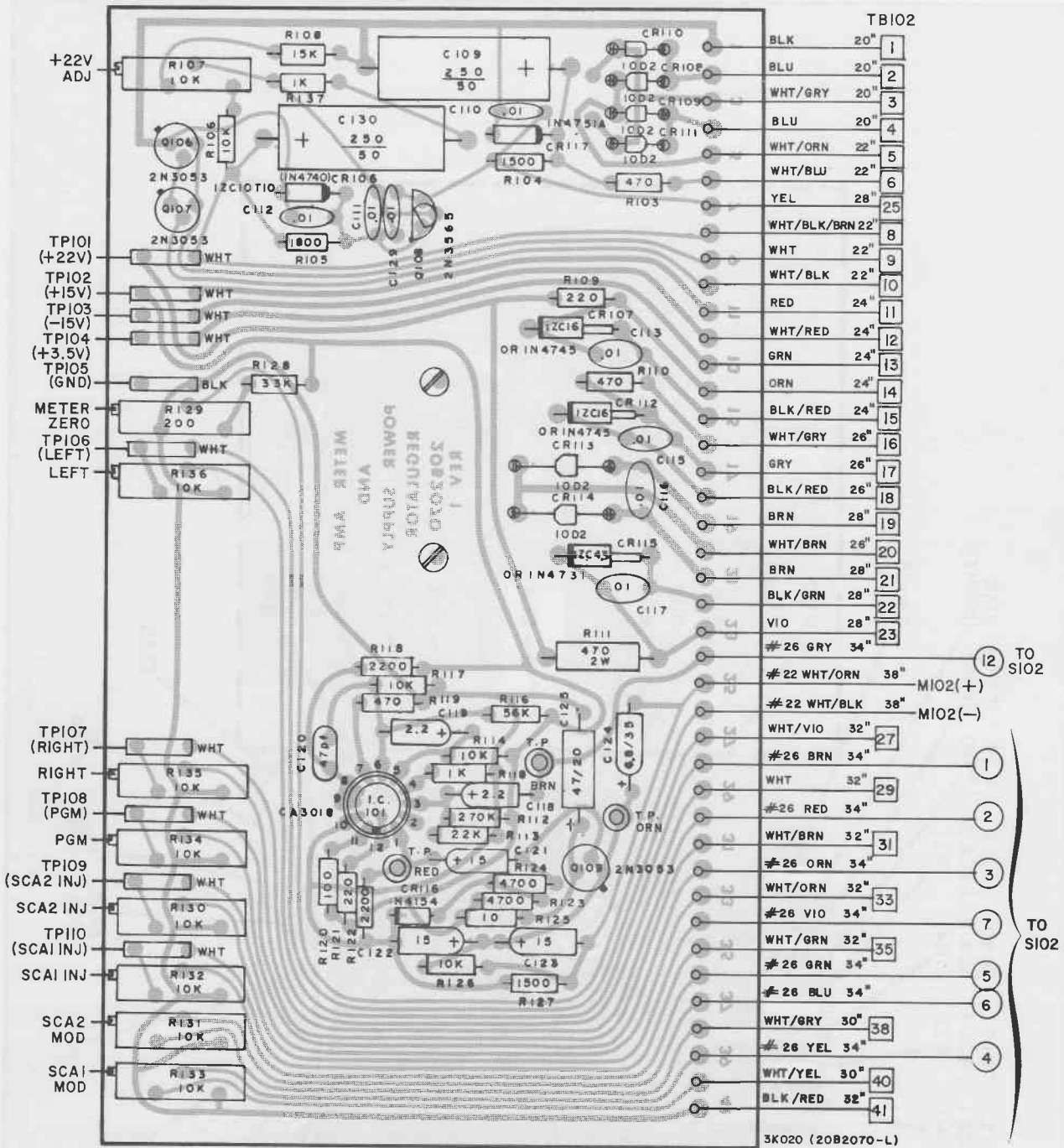

NOTE: UNLESS OTHERWISE SPECIFIED, RESISTOR VALUES ARE IN OHMS, 1/2 WATT, 10%. CAPACITOR VALUES ARE IN MICROFARADS.

Figure 16. Main Frame Metering Amplifier Board, Parts Overlay, Top

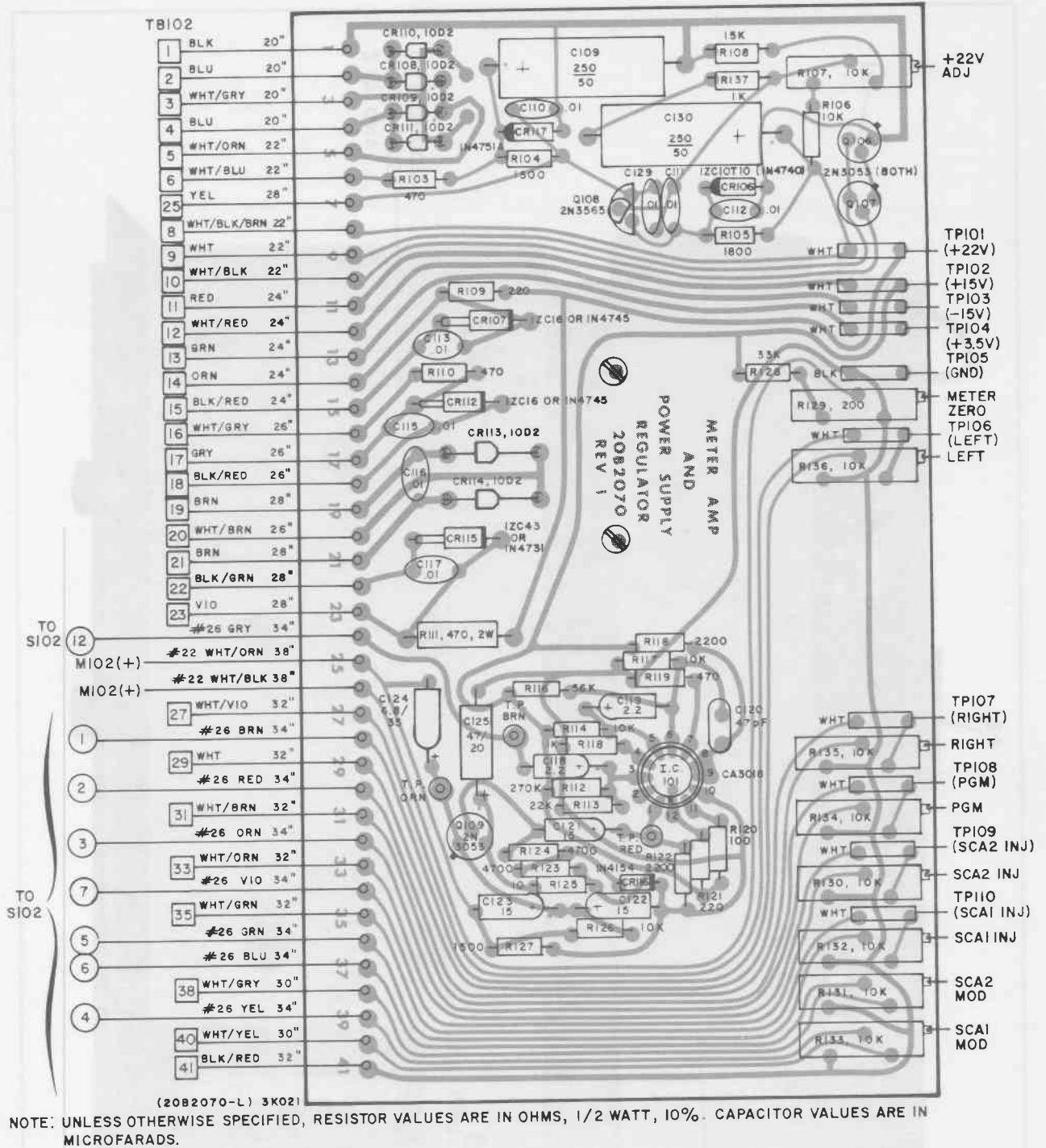

Figure 17. Main Frame Metering Amplifier Board, Parts Overlay, Bottom

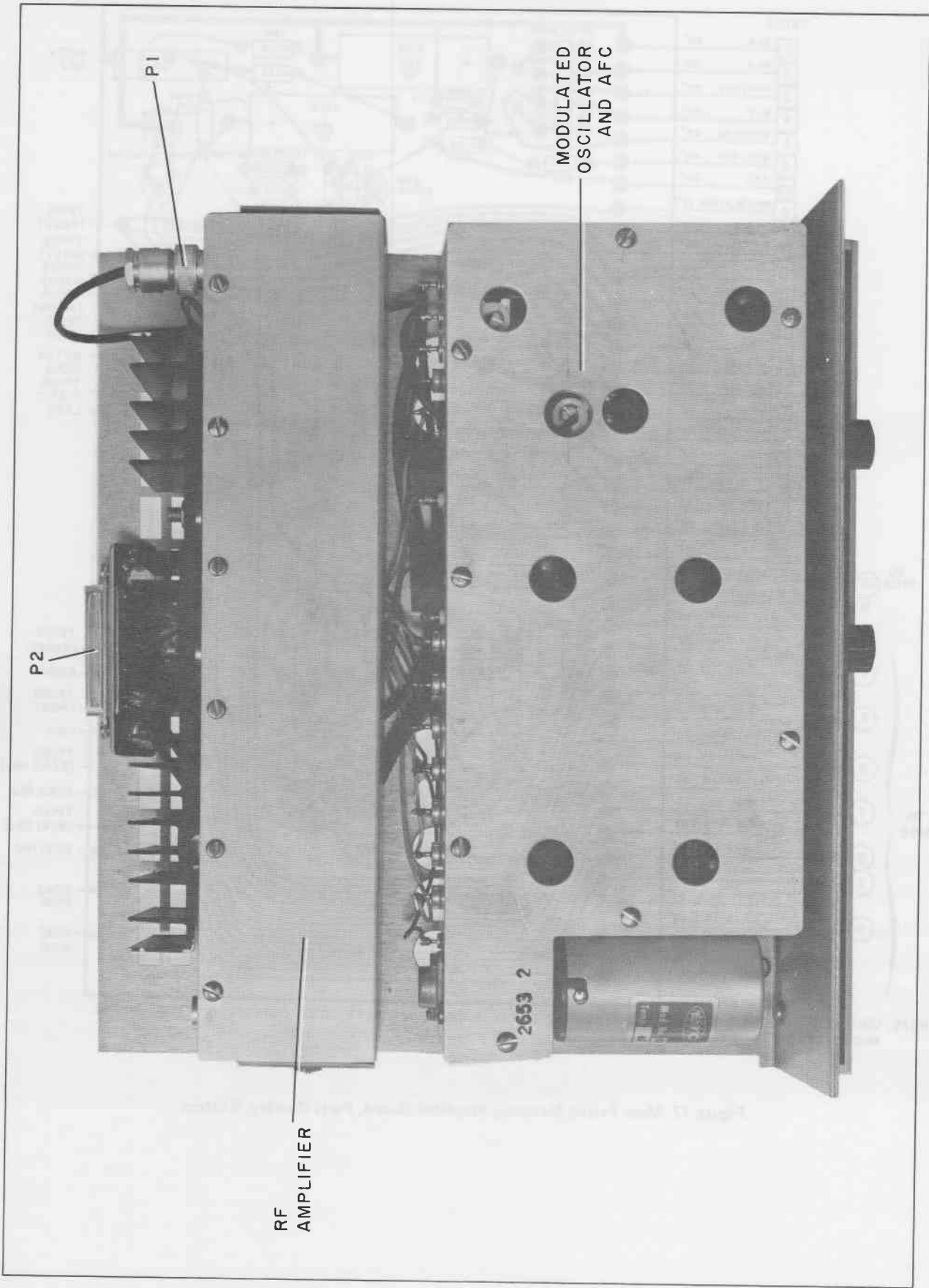

Figure 18. Exciter, Top View

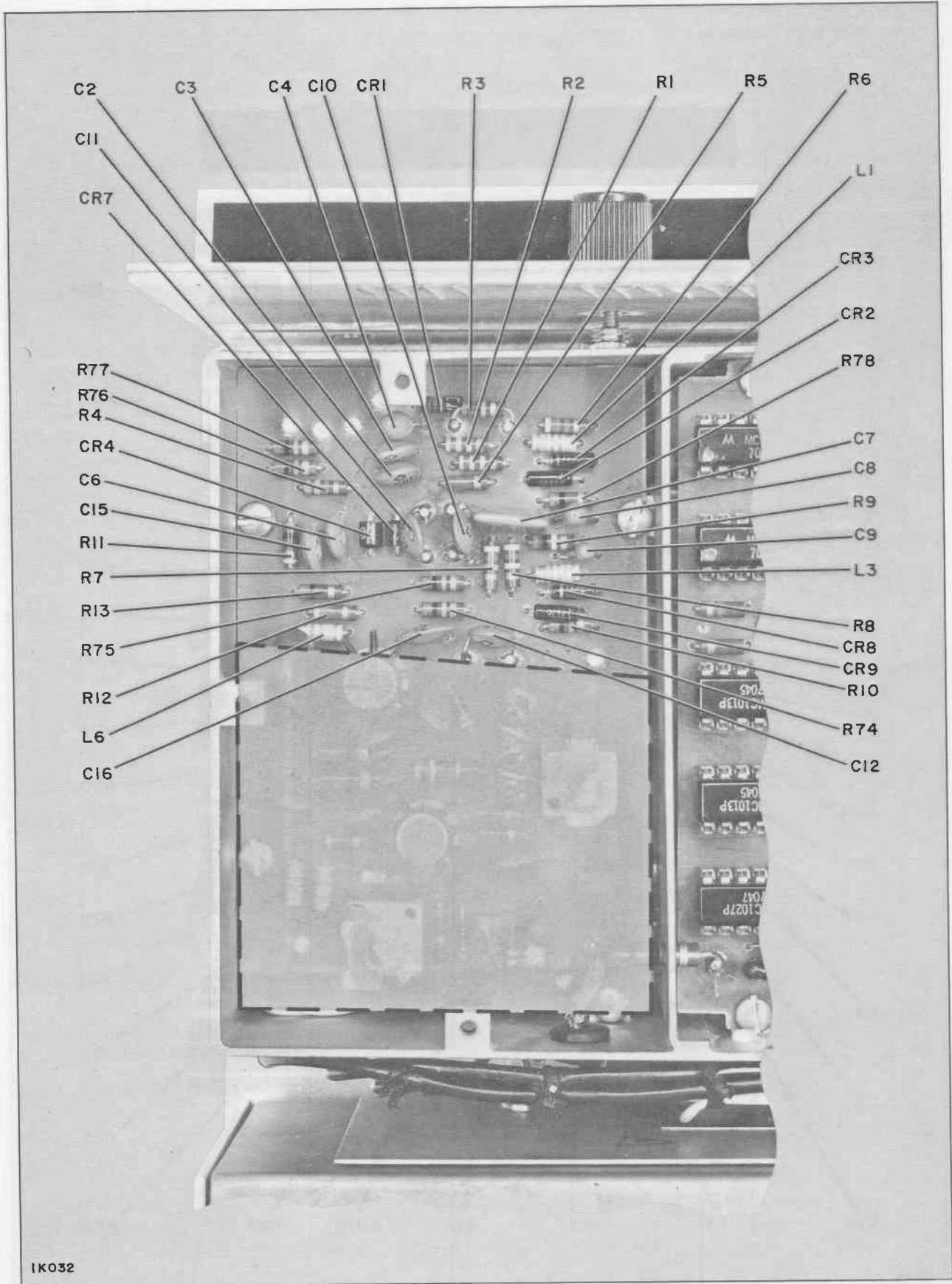

Figure 19. Exciter, Modulated Oscillator Board, Parts Location

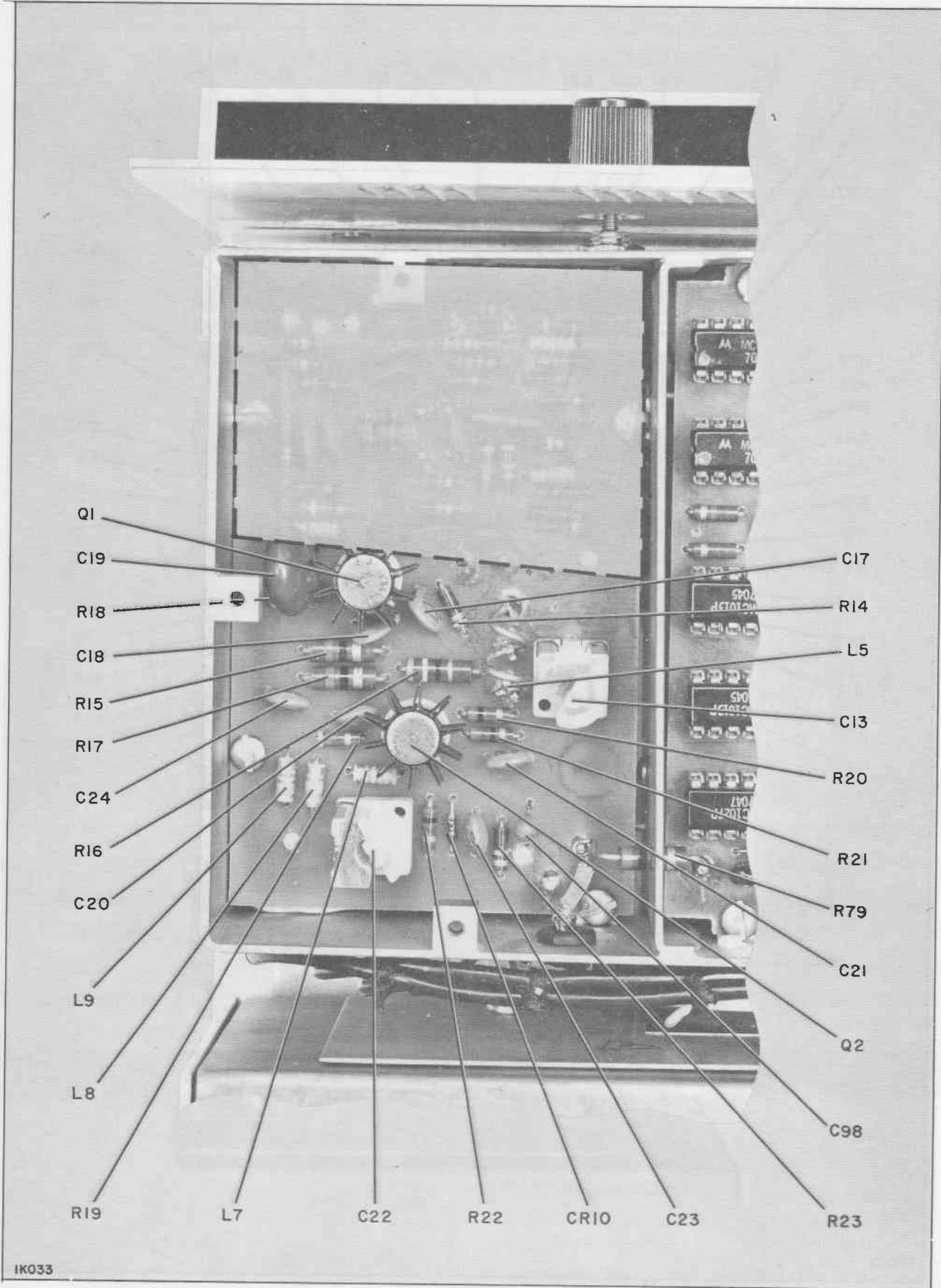

Figure 20. Exciter, Modulated Oscillator Board, Parts Location

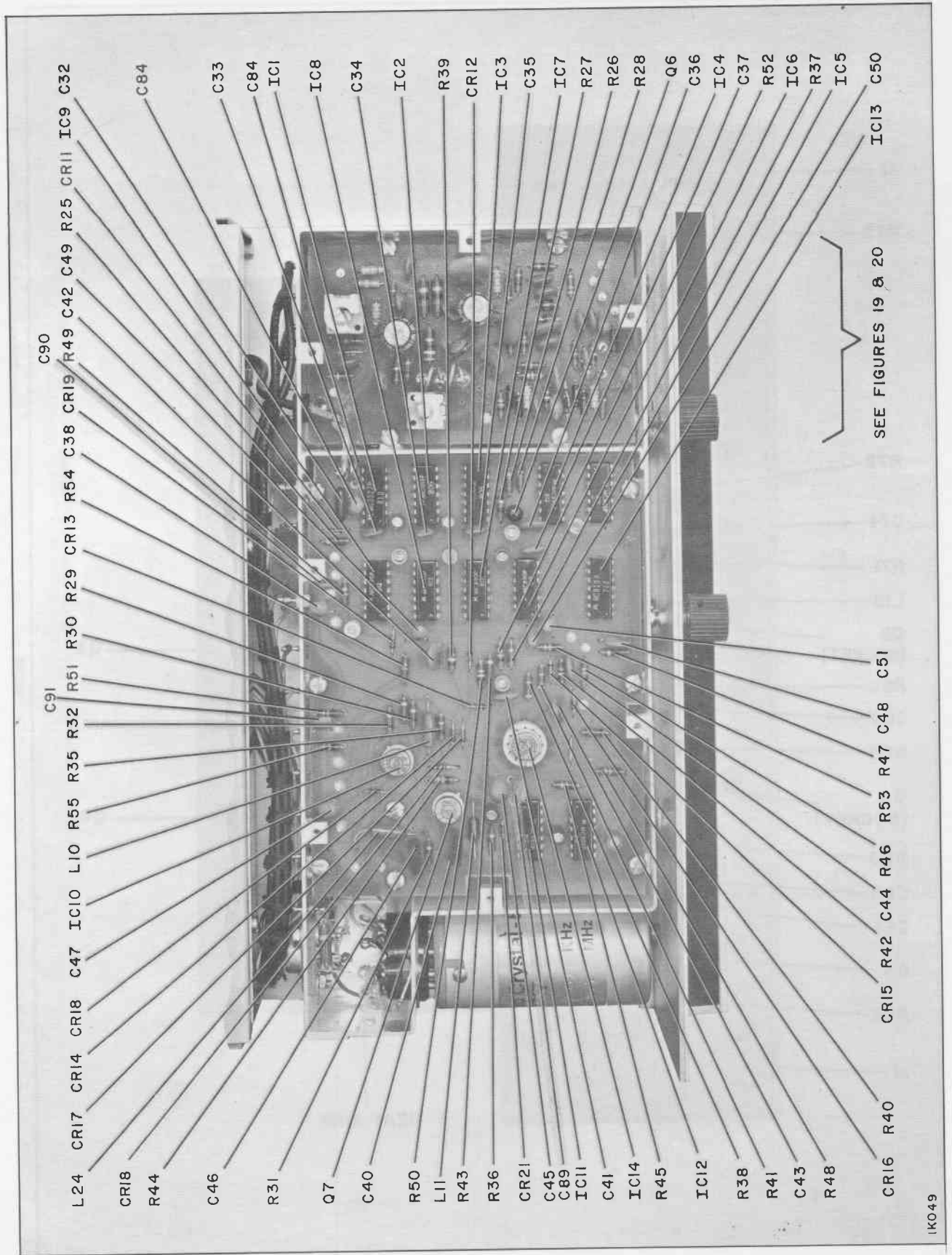

Figure 21. Exciter, AFC Board, Parts Location

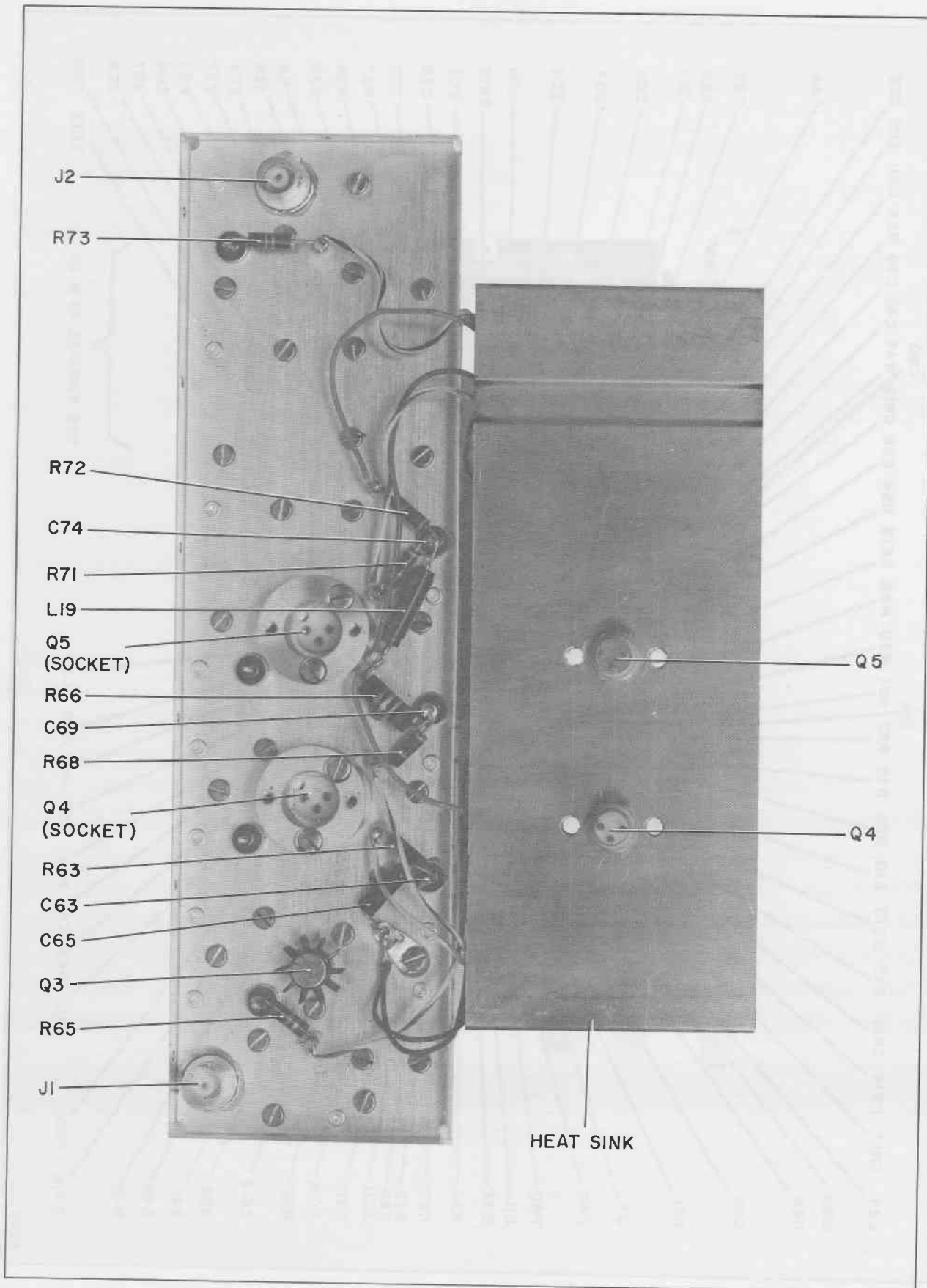

Figure 22. Exciter, RF Amplifier, Parts Location, Top

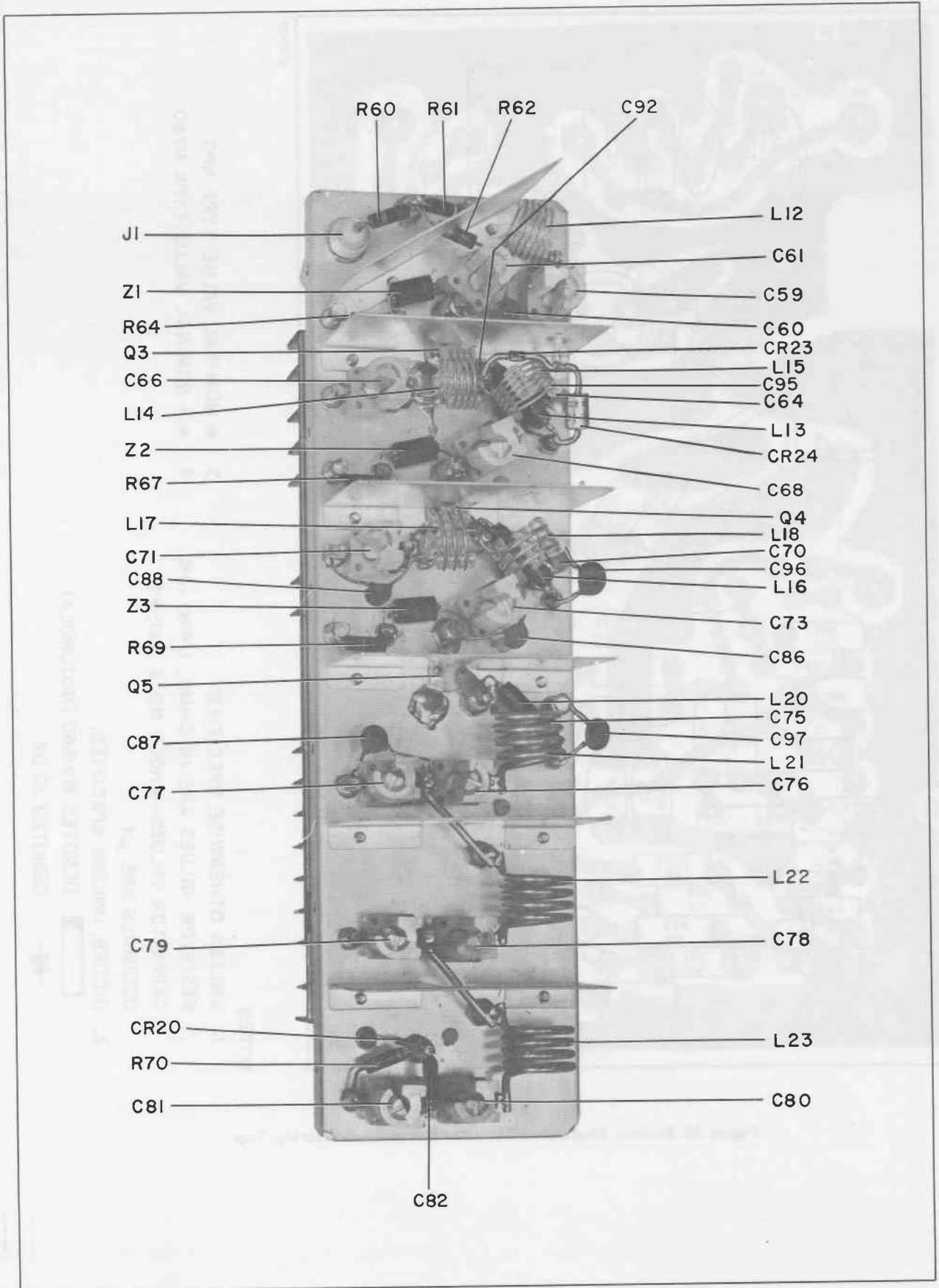
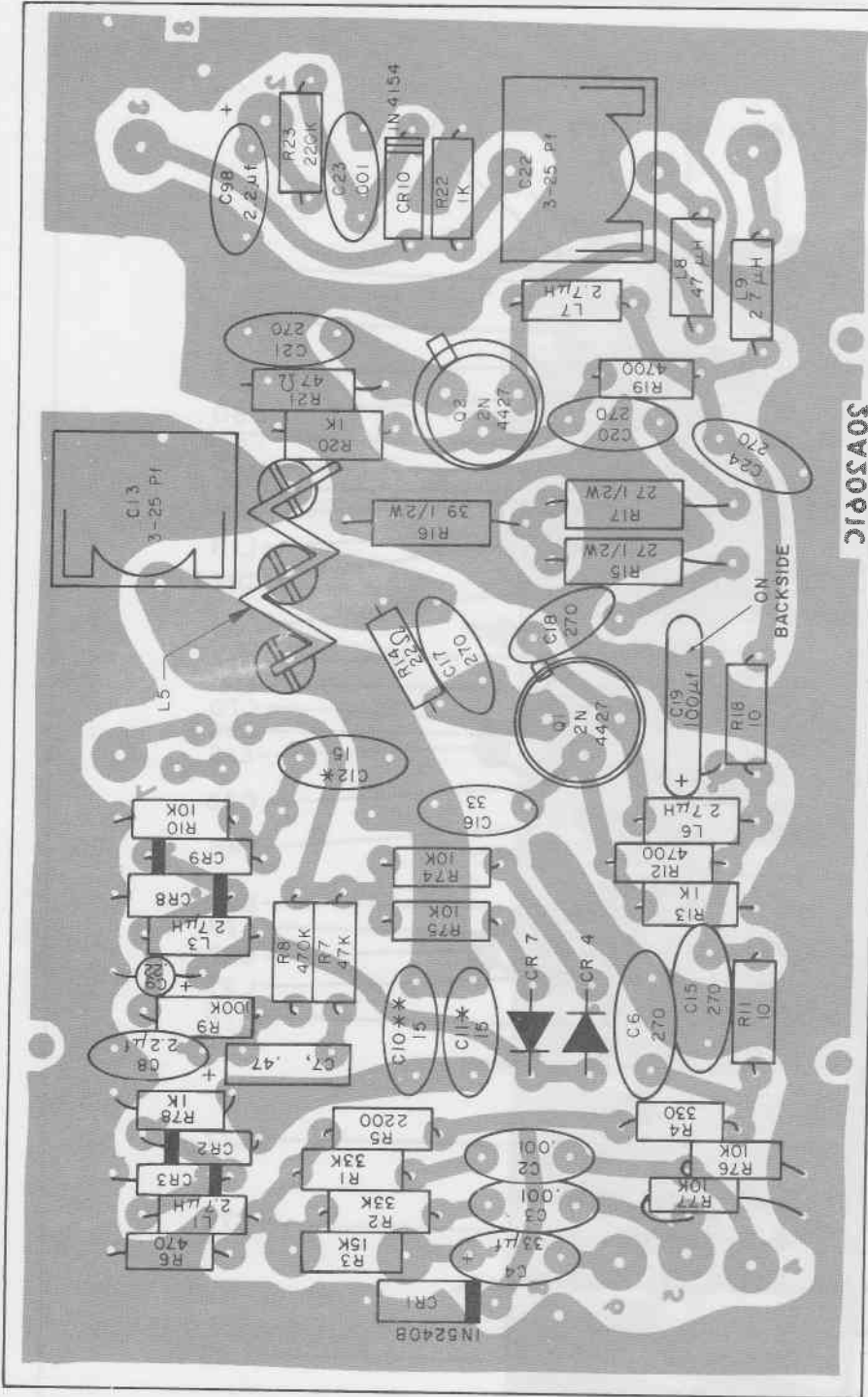

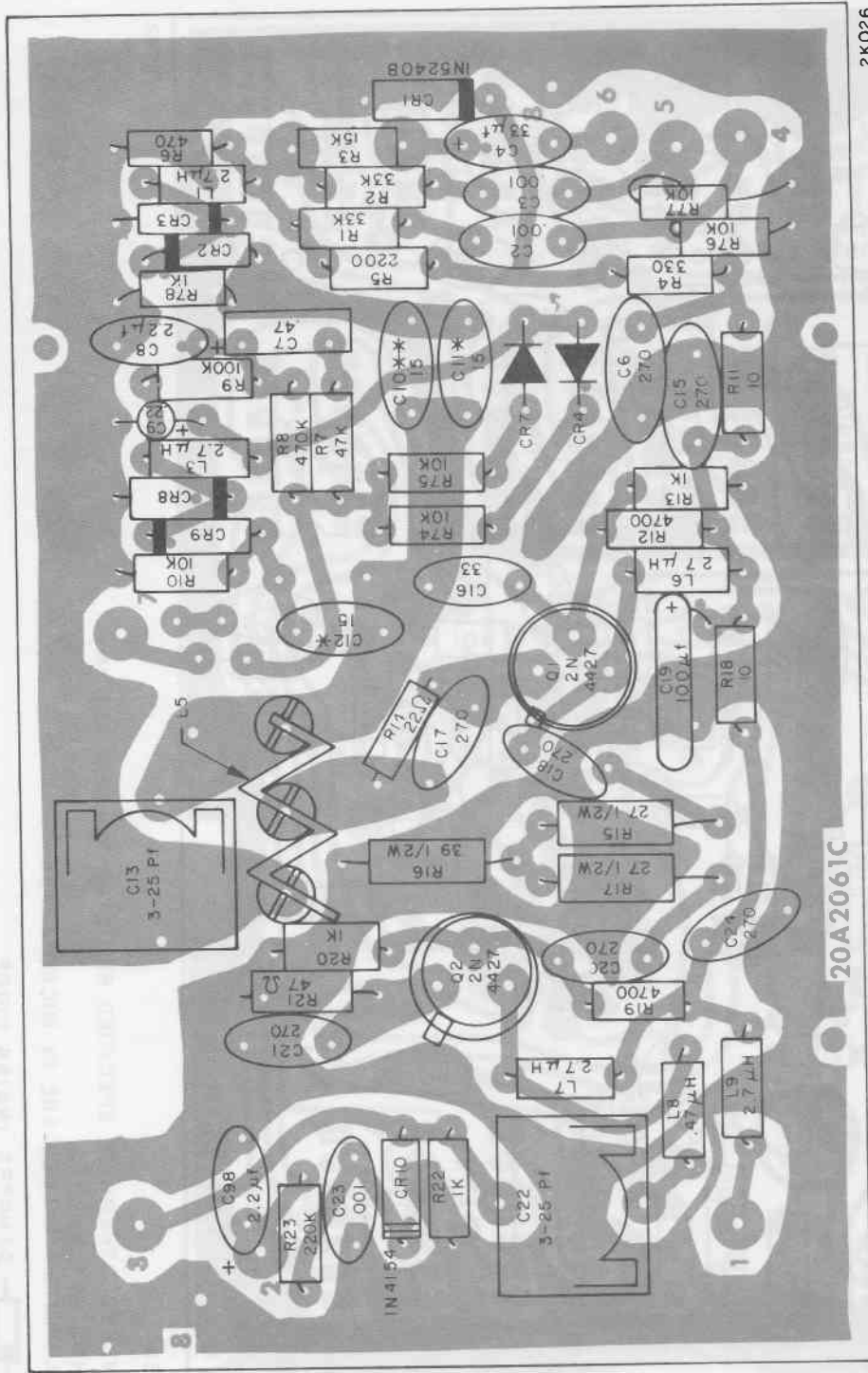

Figure 23. Exciter, RF Amplifier, Parts Location, Bottom



NOTES:

1. UNLESS OTHERWISE SPECIFIED
RESISTOR VALUES ARE IN OHMS, 1/4W, 10%.
CAPACITOR VALUES - WHOLE NO.'S ARE Pf
DECIMALS ARE μ f
2. DIODES, UNLESS SPECIFIED:
 DENOTES MV 840 (MOTOROLA)
 DENOTES IO D2
3. * NOMINAL VALUE TYPE NPO
4. ** NOMINAL VALUE TYPE N750





- NOTES:
1. UNLESS OTHERWISE SPECIFIED
RESISTOR VALUES ARE IN OHMS, 1/4W, 10%.
CAPACITOR VALUES - WHOLE NO.'S ARE Pf
DECIMALS ARE μ f
 2. DIODES, UNLESS SPECIFIED:
 DENOTES MV 840 (MOTOROLA)
 DENOTES IO D2
 3. * NOMINAL VALUE TYPE NPO
 4. ** NOMINAL VALUE TYPE N750

Figure 25. Exciter, Modulated Oscillator Board, Parts Overlay, Bottom



2K022

NOTES:

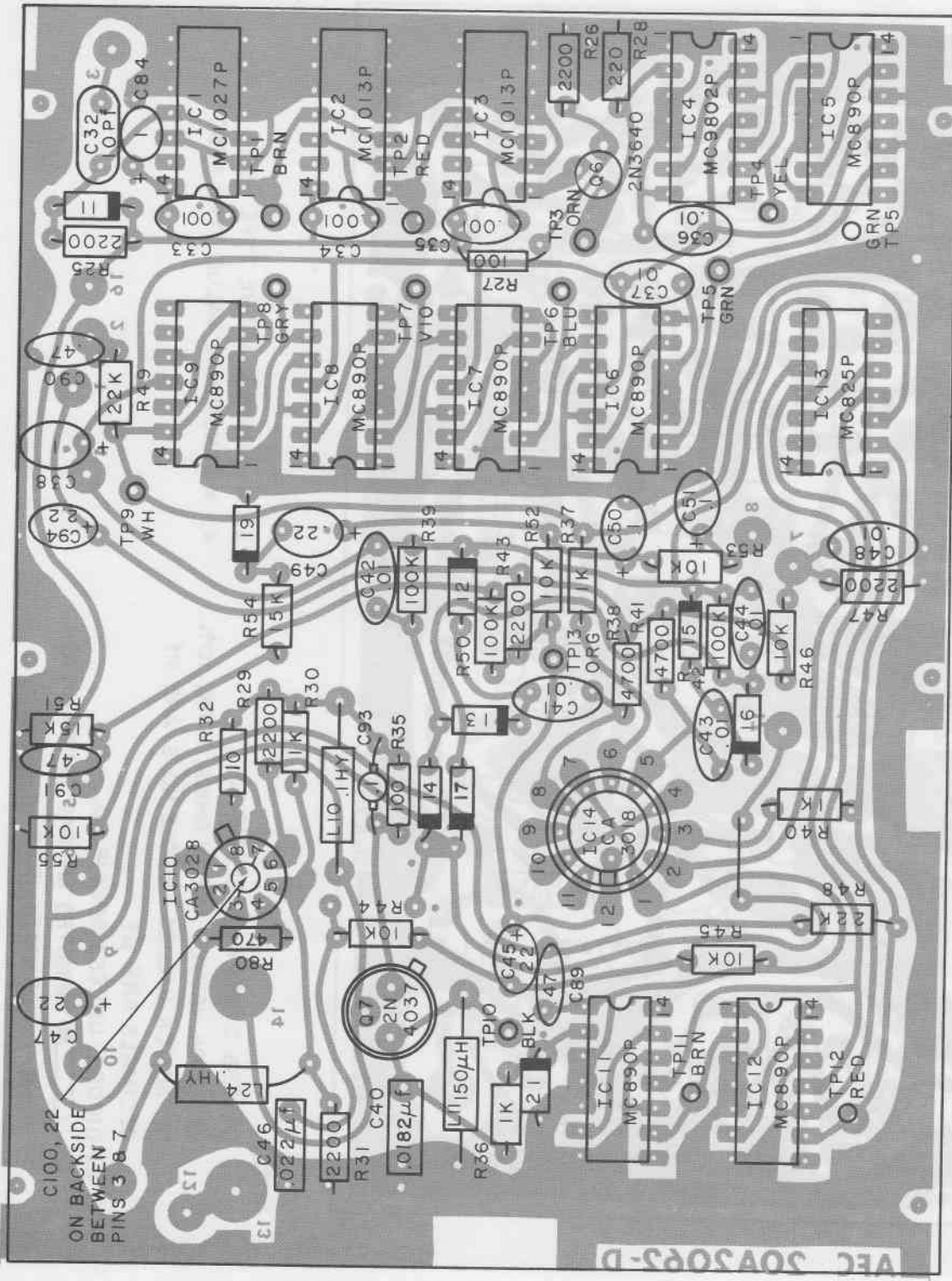
- 1 UNLESS OTHERWISE SPECIFIED RESISTOR VALUES ARE IN OHMS, 1/4 W, 10%.
- CAPACITOR VALUES ARE IN MICROFARADS.

2  DENOTES IN4154 DIODE

Figure 26. Exciter, AFC Board, Parts Overlay, Top

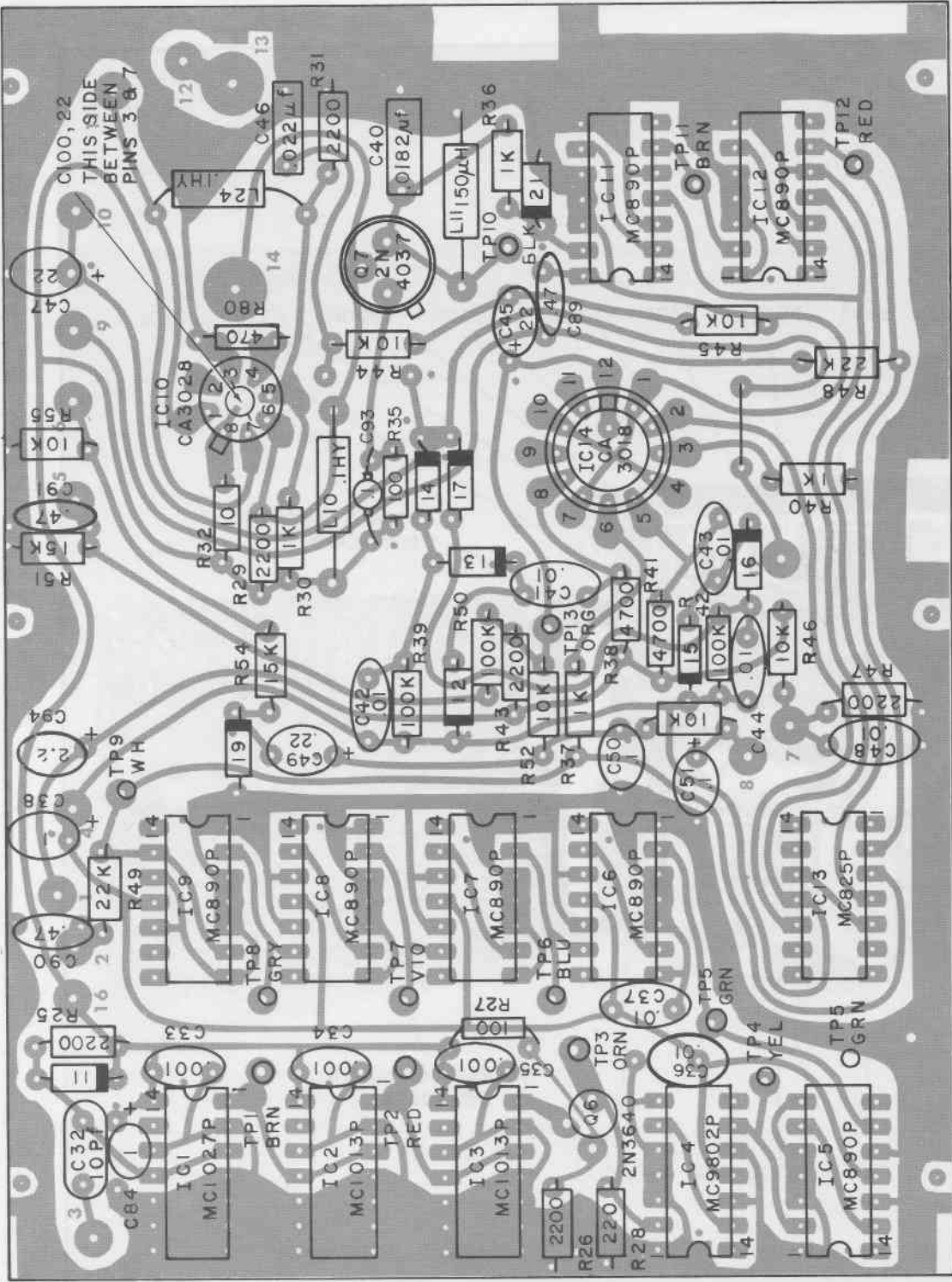

2K021

NOTES:

- 1 UNLESS OTHERWISE SPECIFIED RESISTOR VALUES ARE IN OHMS, 1/4 W, 10%.
- CAPACITOR VALUES ARE IN MICROFARADS.

- 2  DENOTES IN4154 DIODE

Figure 27. Exciter, AFC Board, Parts Overlay, Bottom

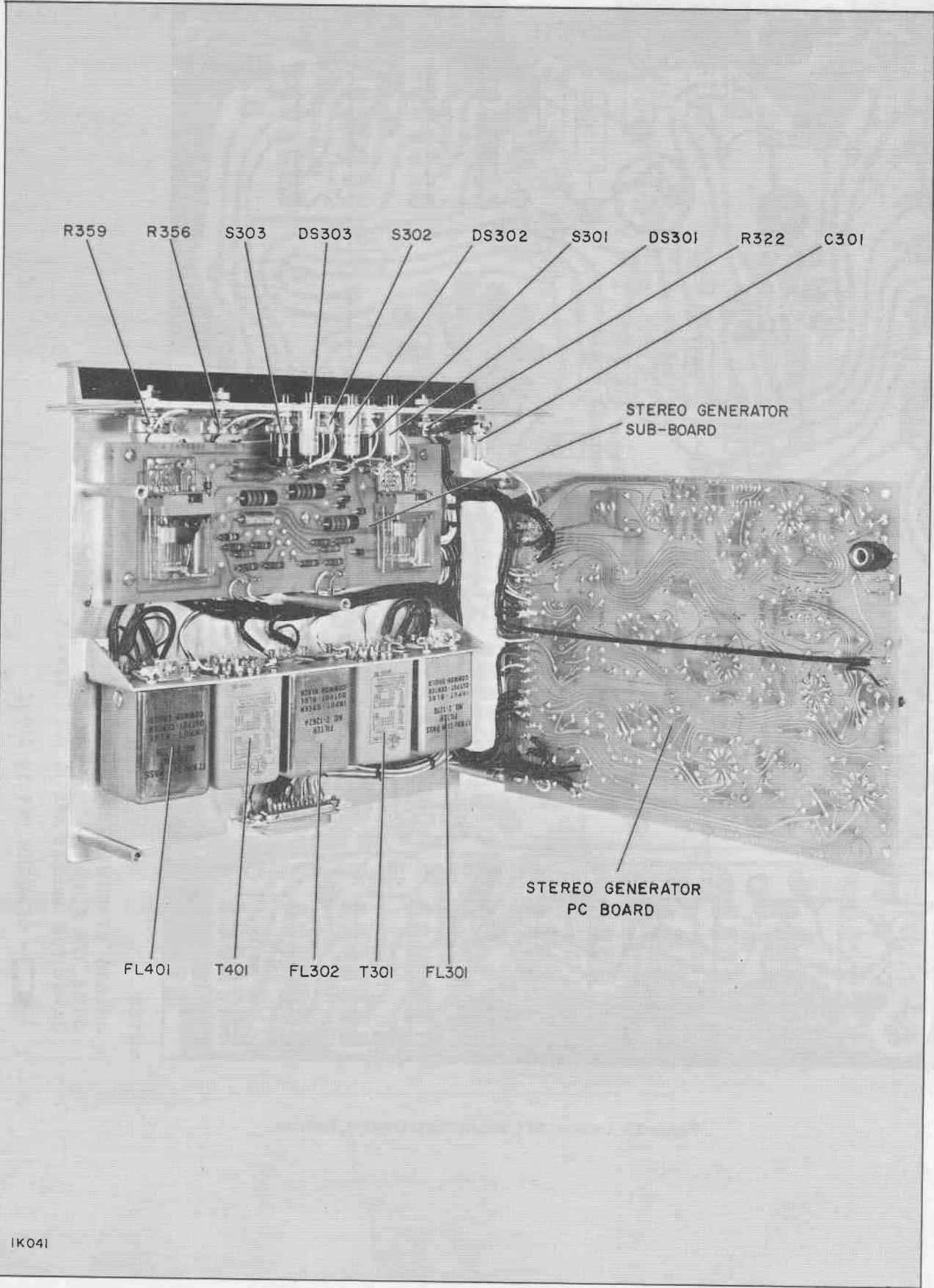
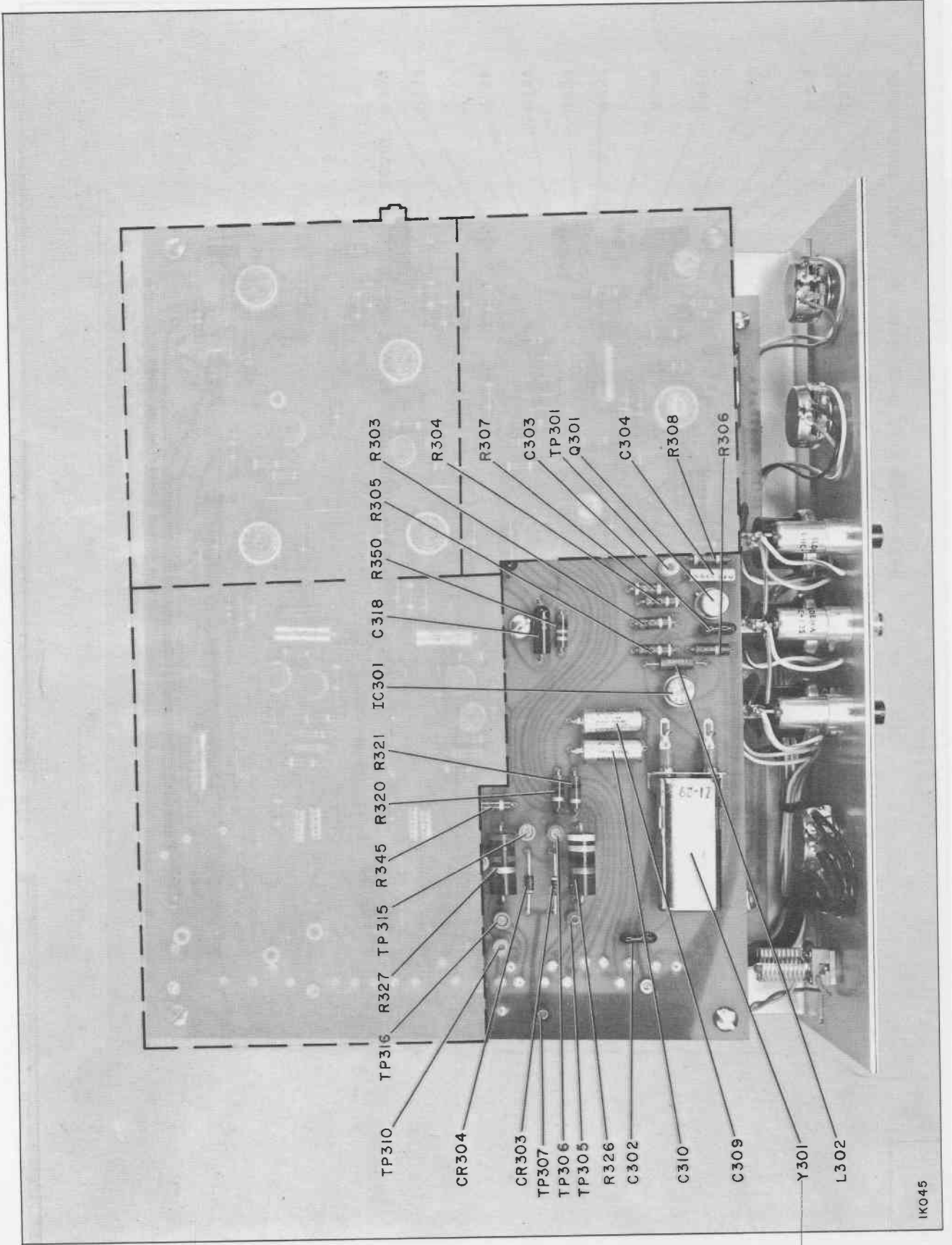
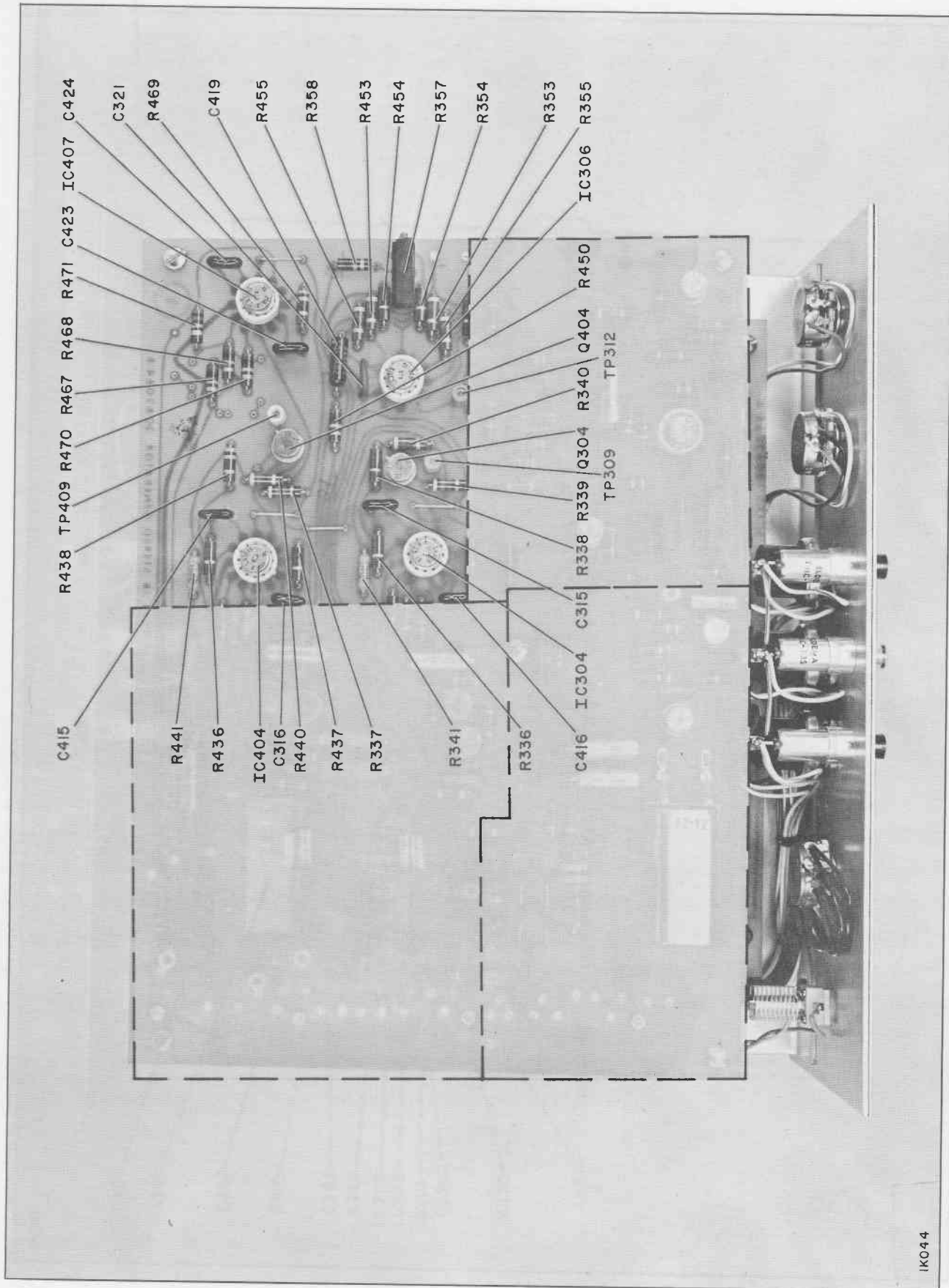

Figure 28. Stereo Generator, Overall View



IK045

Figure 29. Stereo Generator Board, Parts Location



IK044

Figure 30. Stereo Generator Board, Parts Location

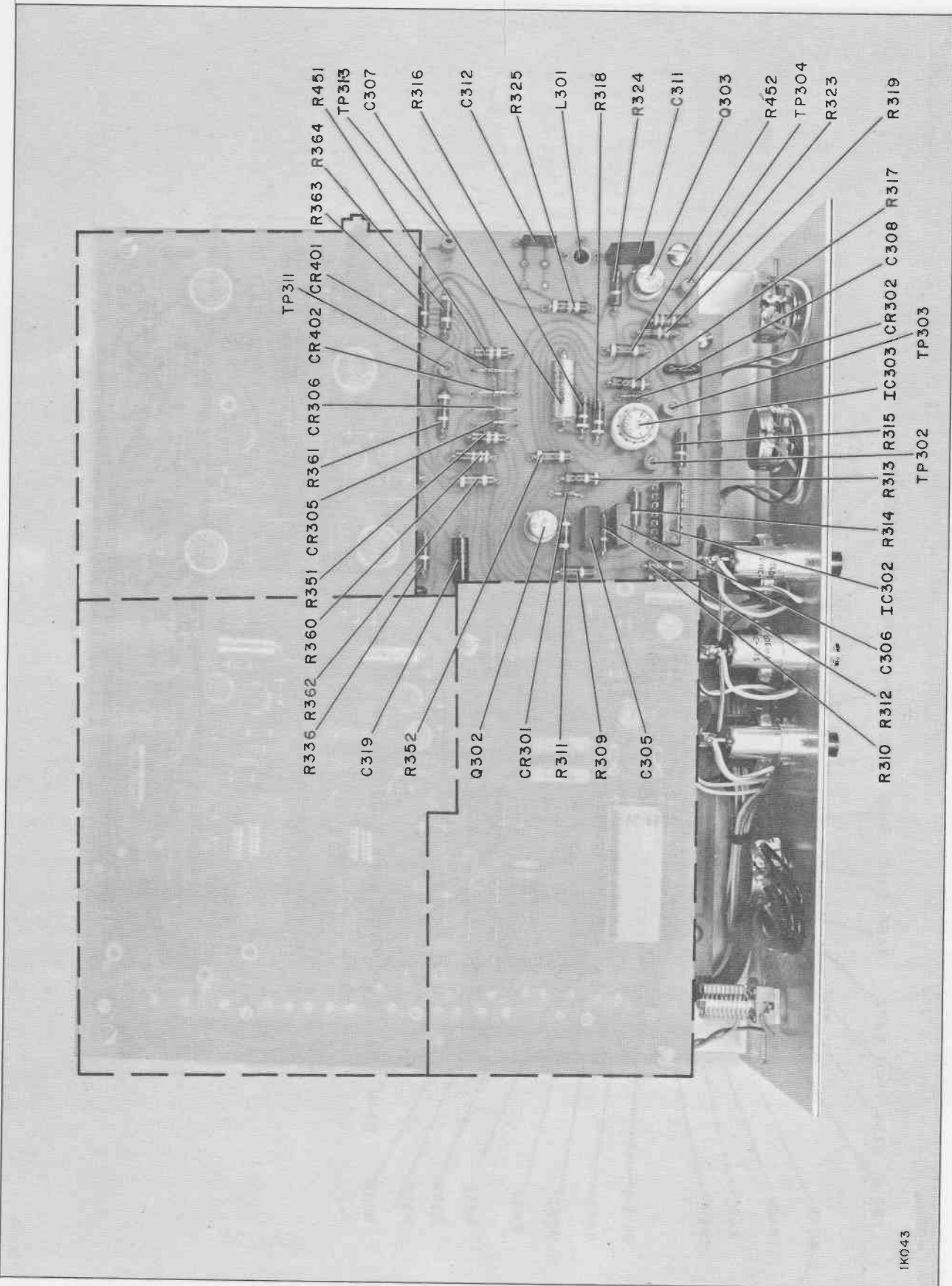

Figure 32. Stereo Generator Board, Parts Location

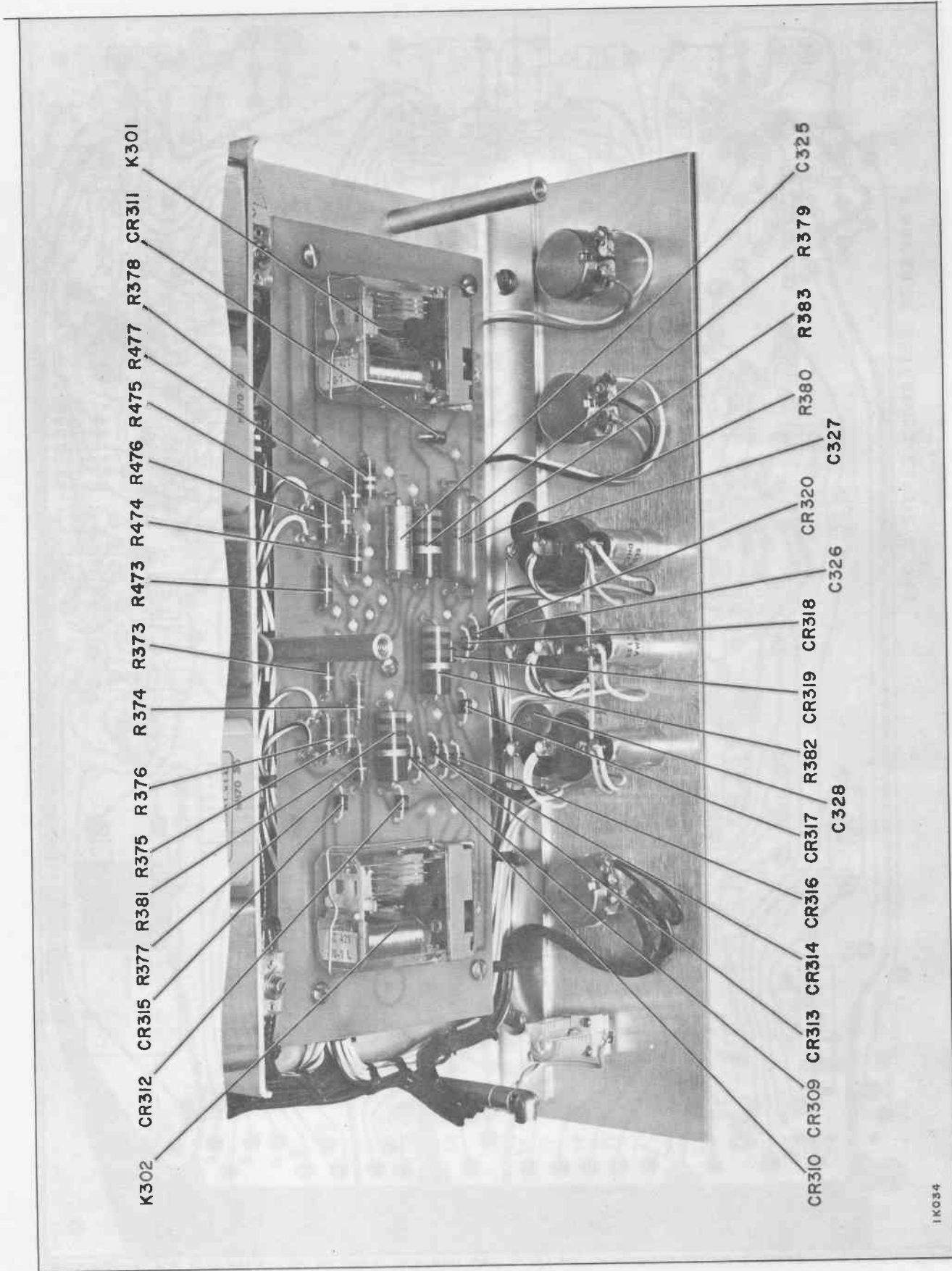
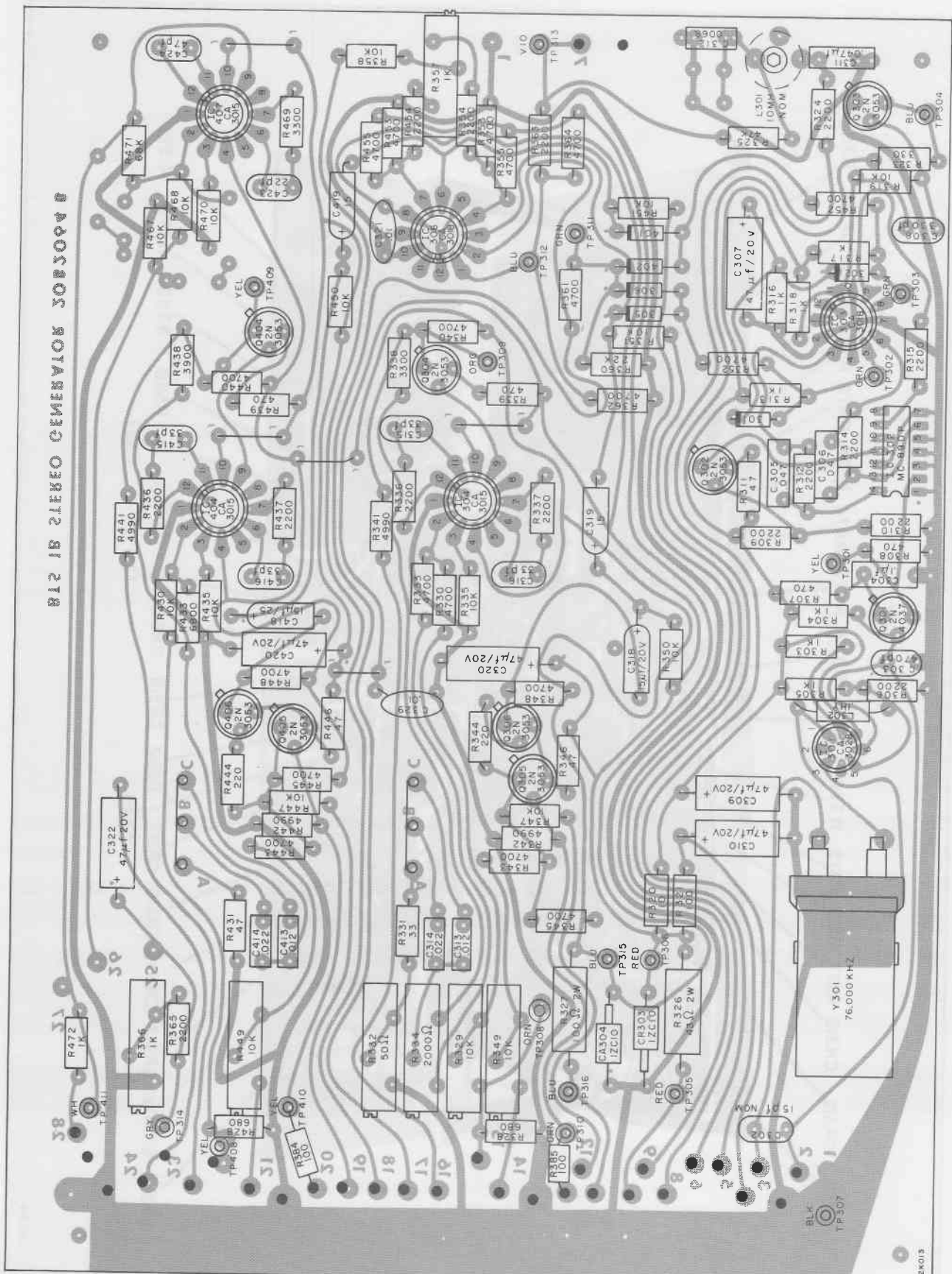

Figure 33. Stereo Generator Sub-Board, Parts Location



NOTES : 1. UNLESS OTHERWISE SPECIFIED RESISTOR VALUES ARE IN OHMS, 1/2W, 10%, CAPACITOR VALUES ARE μ F'S. 2.  =4154 DIODE.

Figure 34. Stereo Generator Board, Parts Overlay, Top



B15 1B STEREO GENERATOR 20B2064 B

NOTES: 1. UNLESS OTHERWISE SPECIFIED RESISTOR VALUES ARE IN OHMS, 1/2W, 10%. CAPACITOR VALUES ARE μF'S. 2. □ = 4154 DIODE

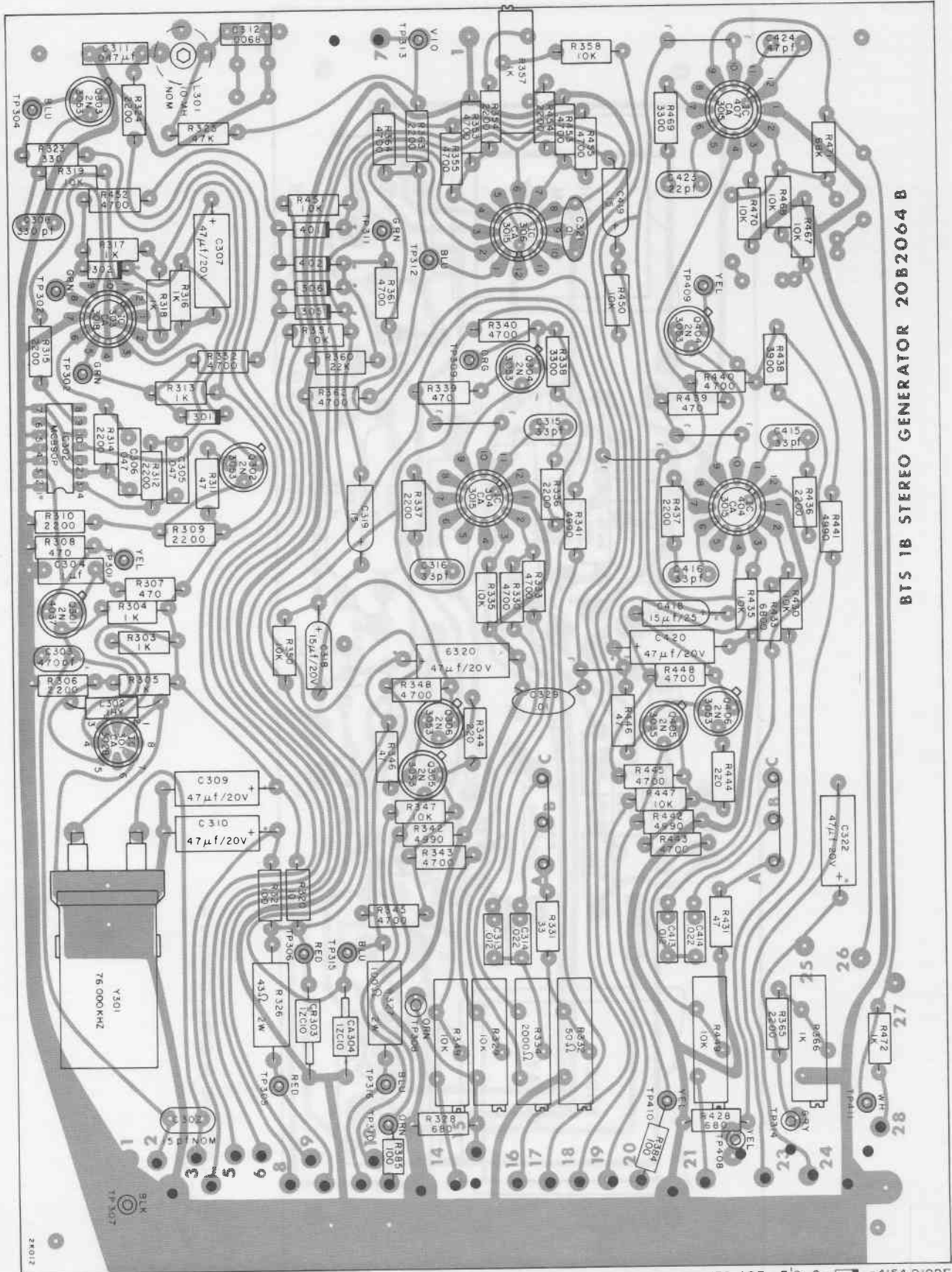
Figure 35. Stereo Generator Board, Parts Overlay, Bottom

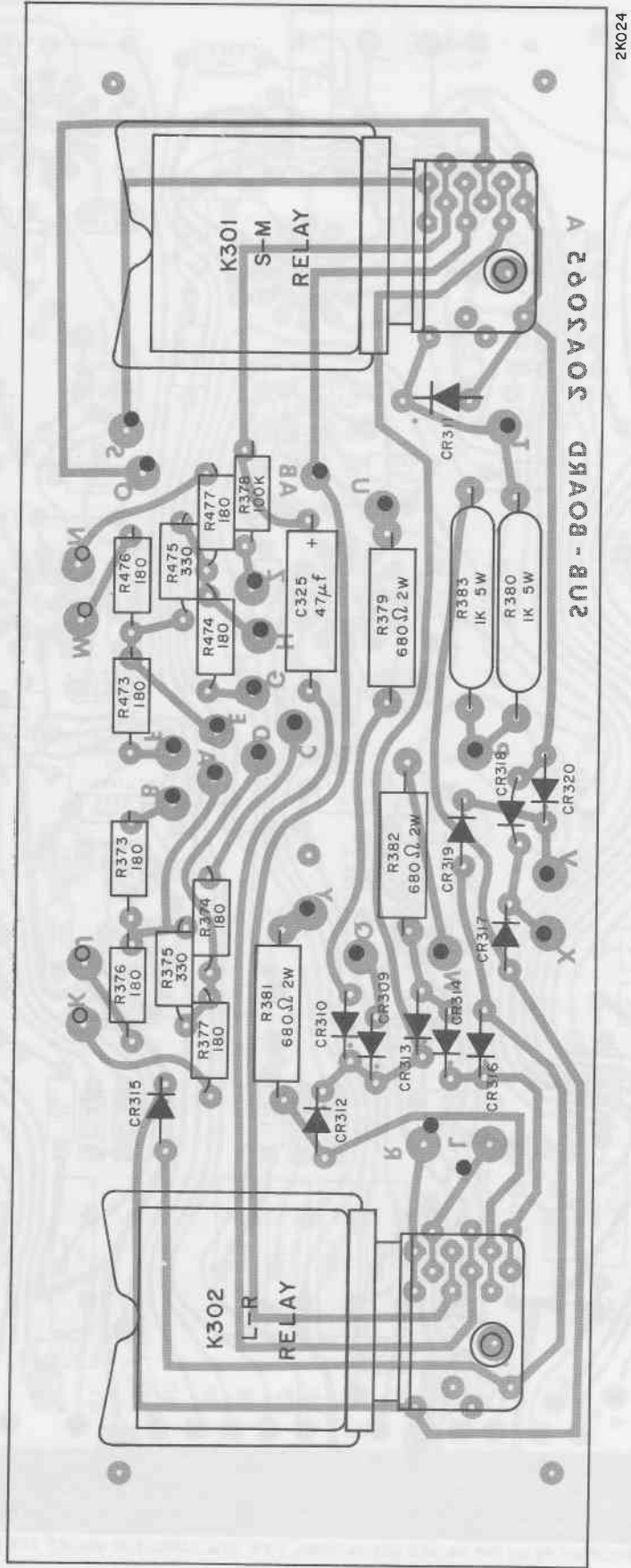

NOTES:
1. RESISTOR VALUES ARE IN OHMS, 1/2W, 10%
2. DIODES ARE 10D2

Figure 36. Stereo Generator Sub-Board, Parts Overlay, Top

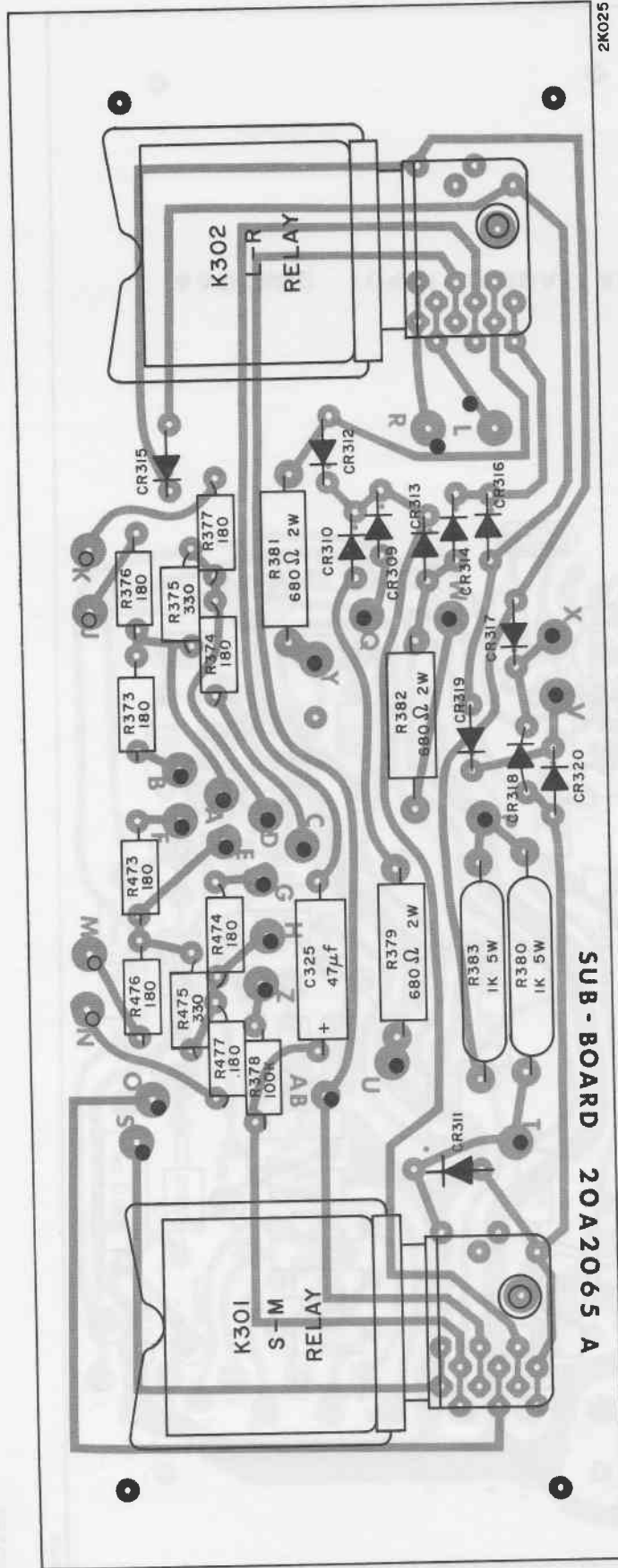

- NOTES:
1. RESISTOR VALUES ARE IN OHMS, 1/2 W, 10%
 2. DIODES ARE 10 D2

Figure 37. Stereo Generator Sub-Board, Parts Overlay, Bottom

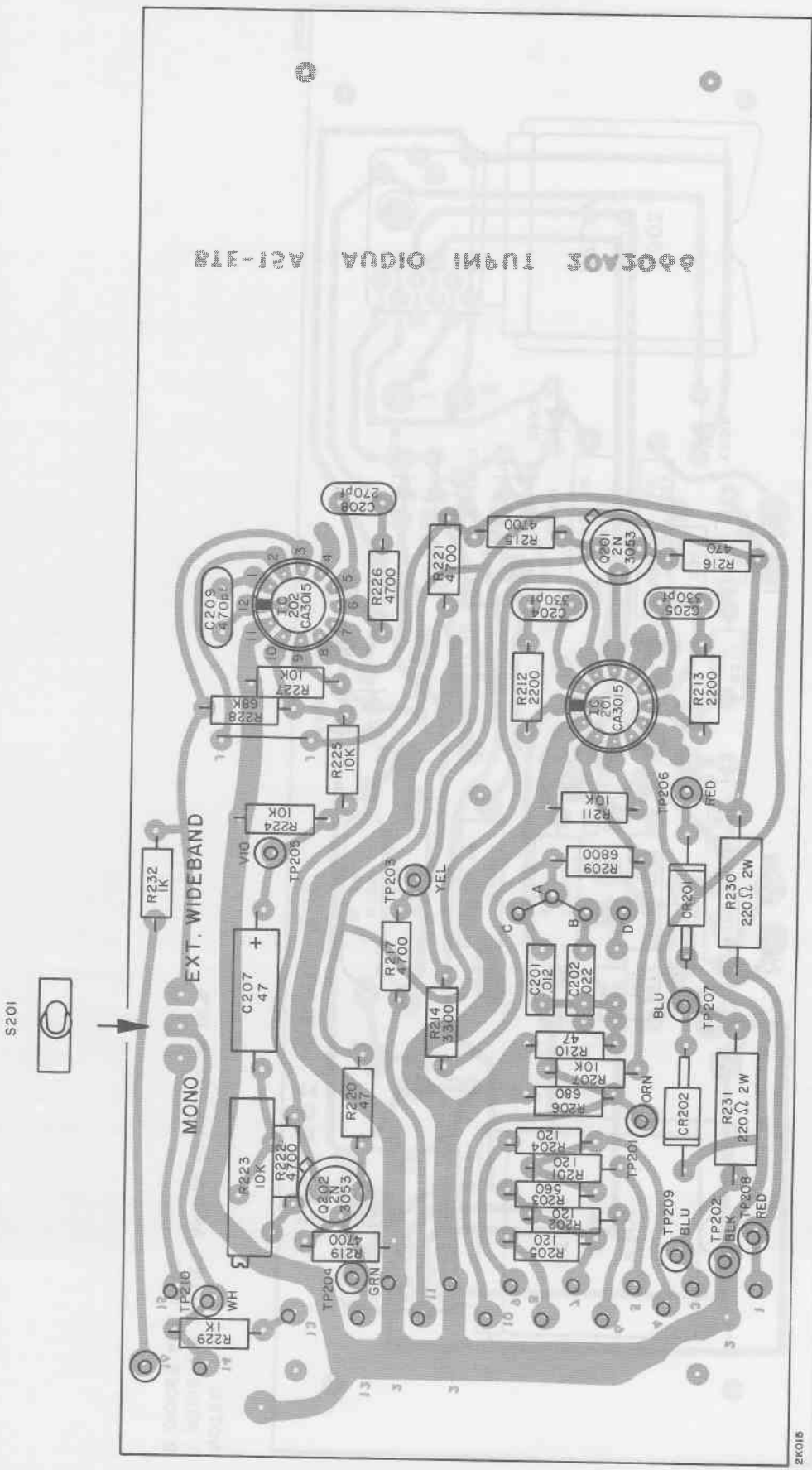

3903A05 TUNN1 IQDUA A21-12A

NOTES:

- 1. UNLESS OTHERWISE SPECIFIED RESISTOR VALUES ARE IN OHMS, 1/2W, 10%.

Figure 38. Monaural Audio Board, Parts Overlay, Top

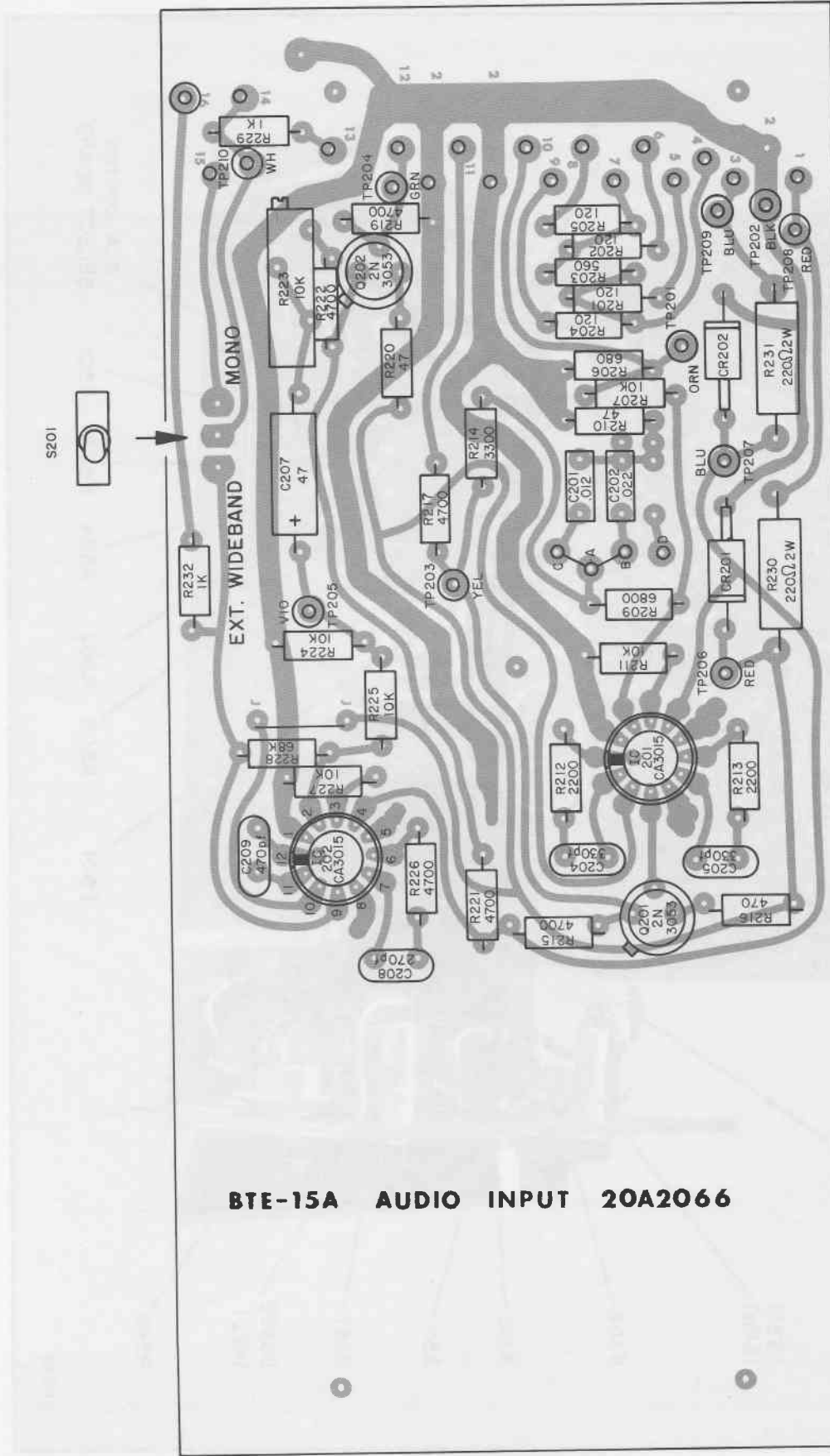

BTE-15A AUDIO INPUT 20A2066

NOTES:
 1. UNLESS OTHERWISE SPECIFIED RESISTOR VALUES
 ARE IN OHMS, 1/2W, 10%.

Figure 39. Monaural Audio Board, Parts Overlay, Bottom

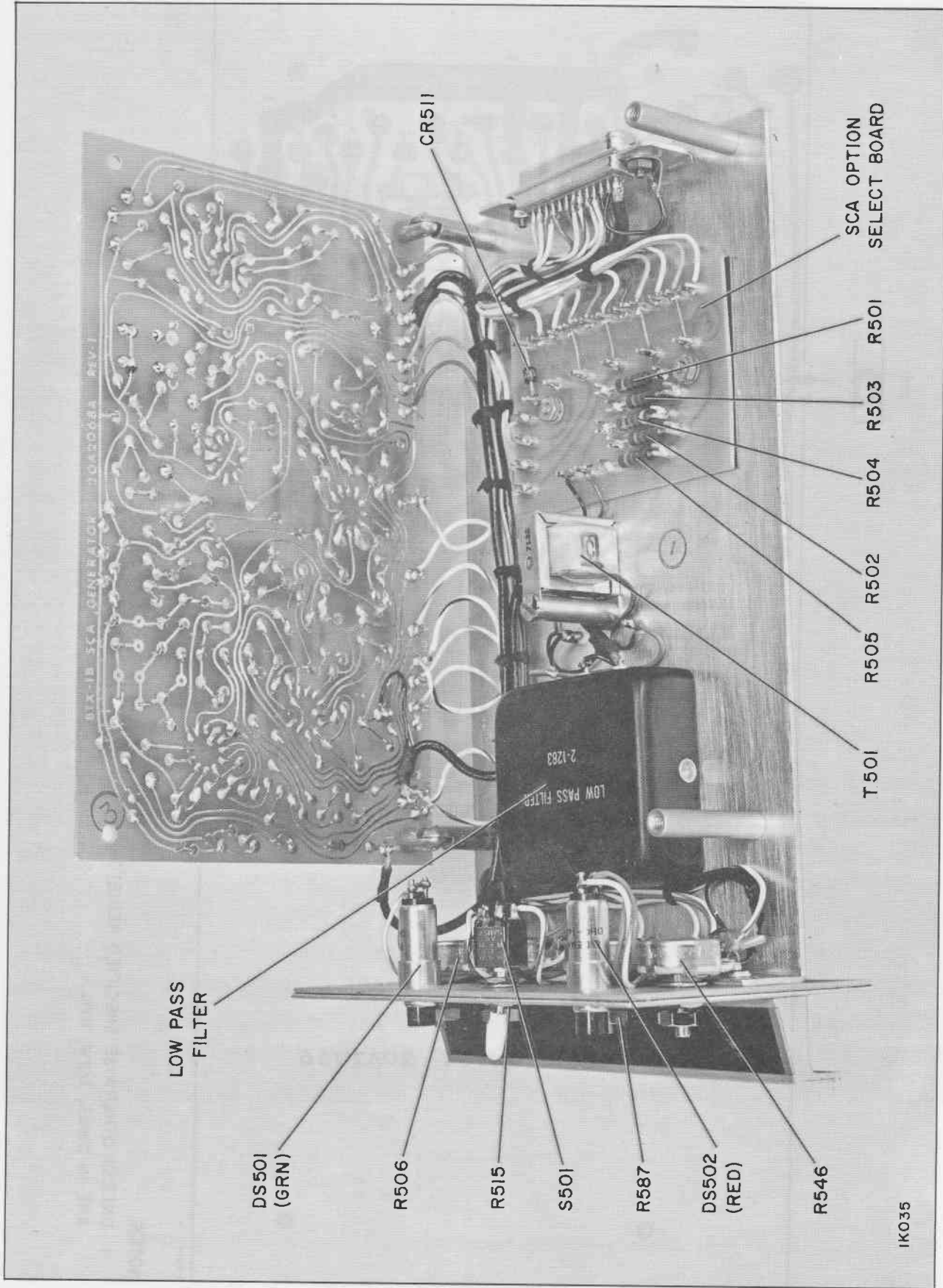

Figure 40. SCA Generator, Overall View

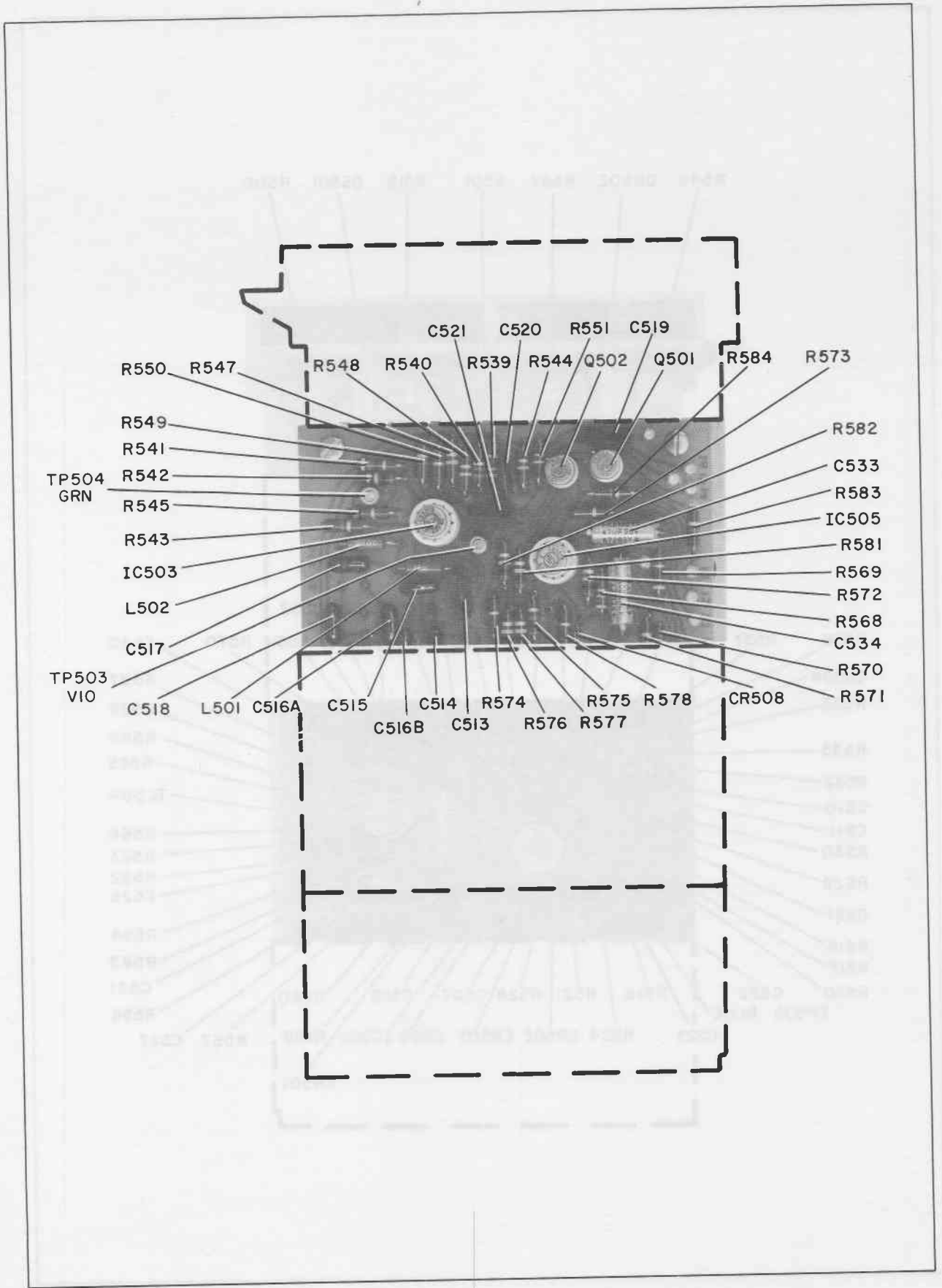

Figure 41. SCA Generator Board, Parts Location, Ser. No. 1 through 999

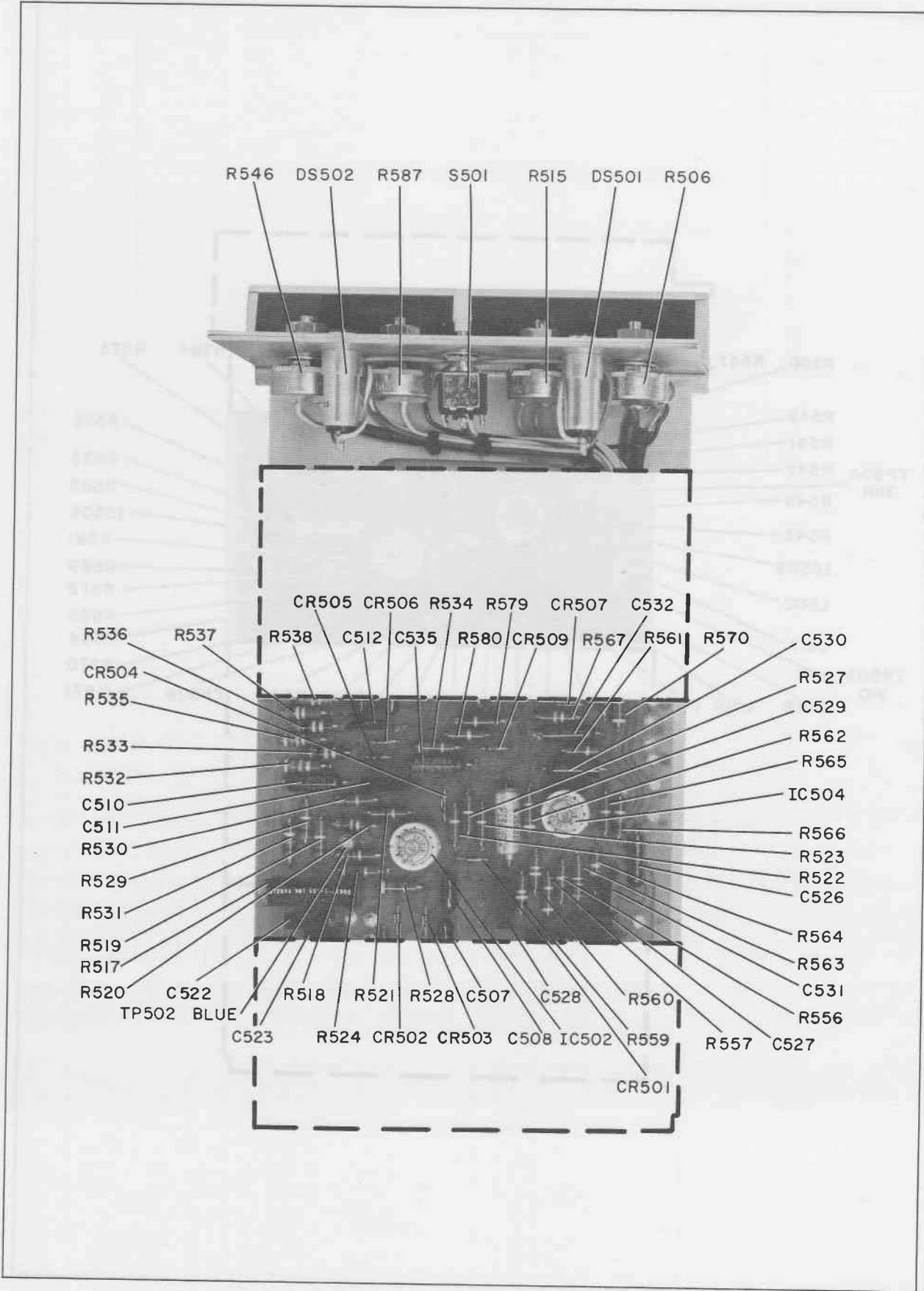
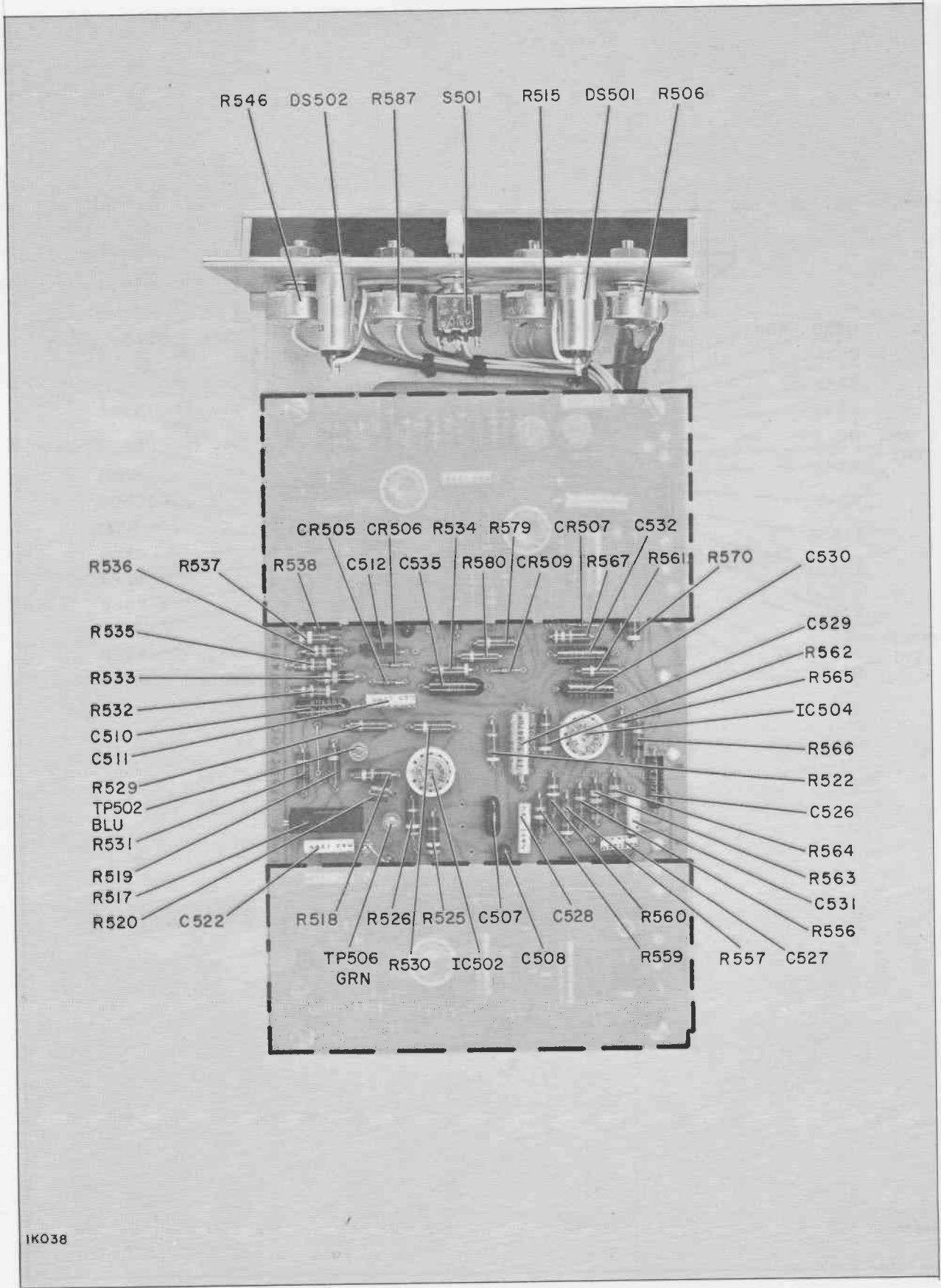
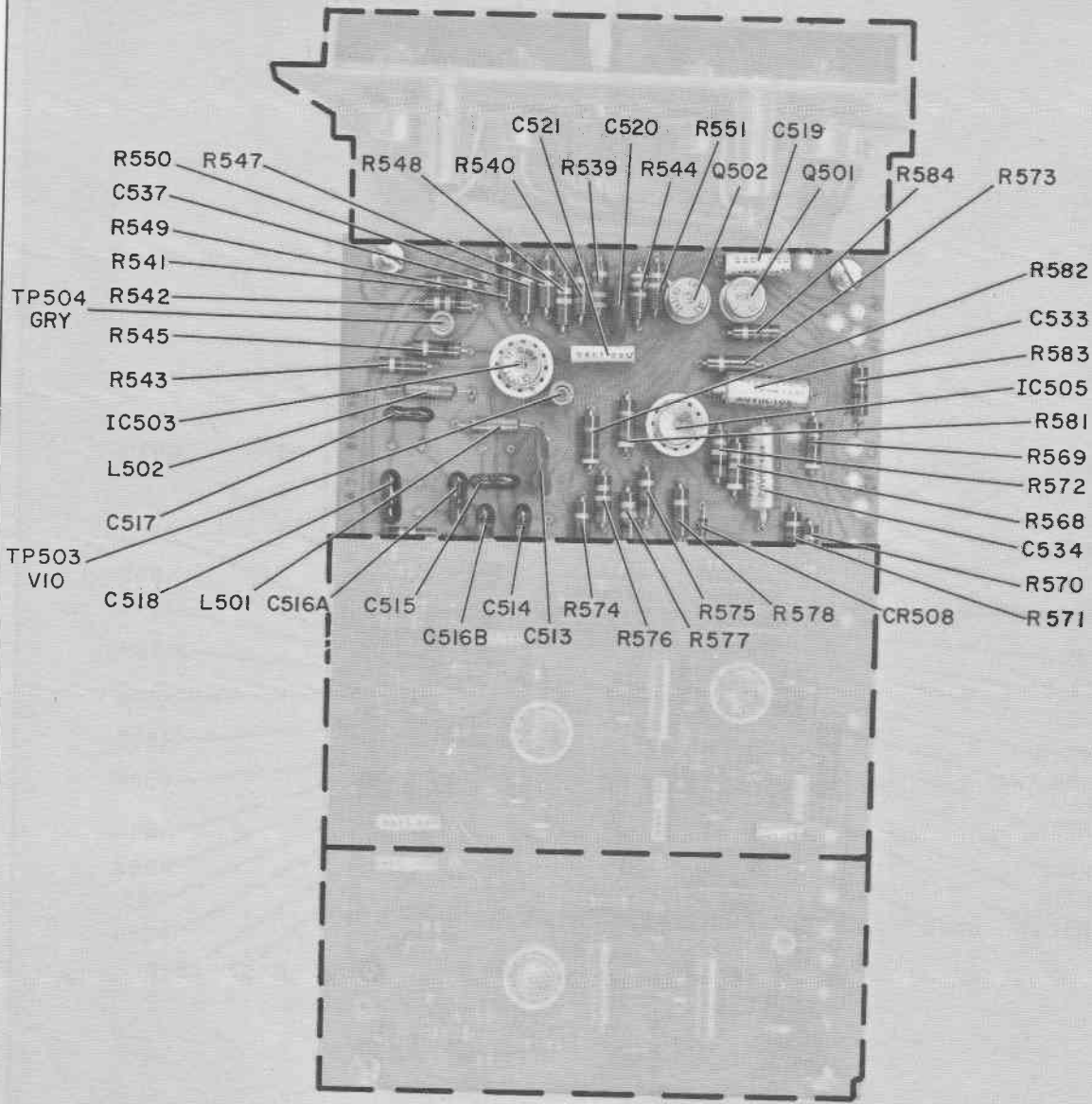

Figure 42. SCA Generator Board, Parts Location, Ser. No. 1 through 999



IK038

Figure 42a. SCA Generator Board, Parts Location, Ser. No. 1000 and Up



IK036

Figure 42b. SCA Generator Board, Parts Location, Ser. No. 1000 and Up

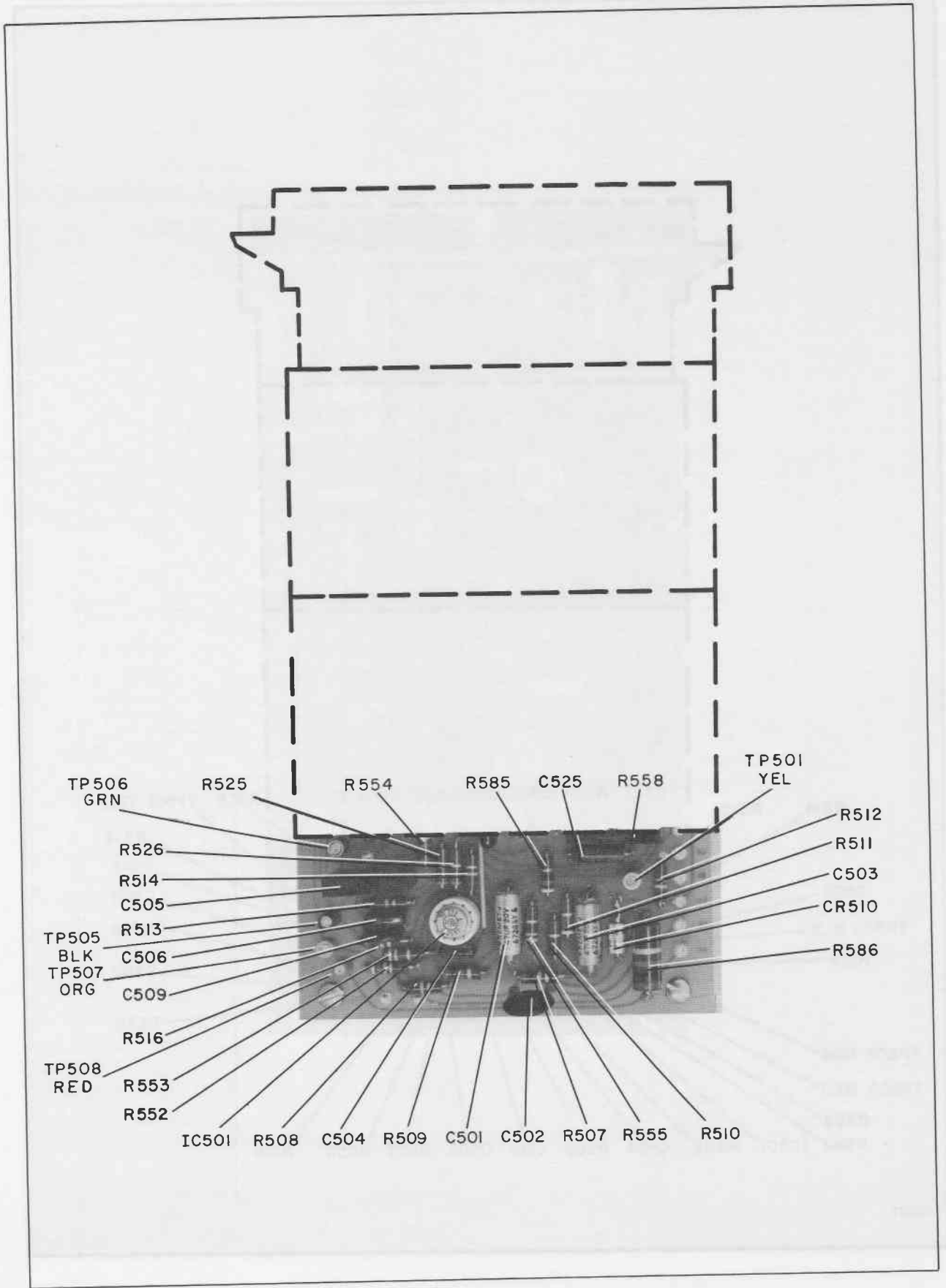

Figure 43. SCA Generator Board, Parts Location, Ser. No. 1 through 999

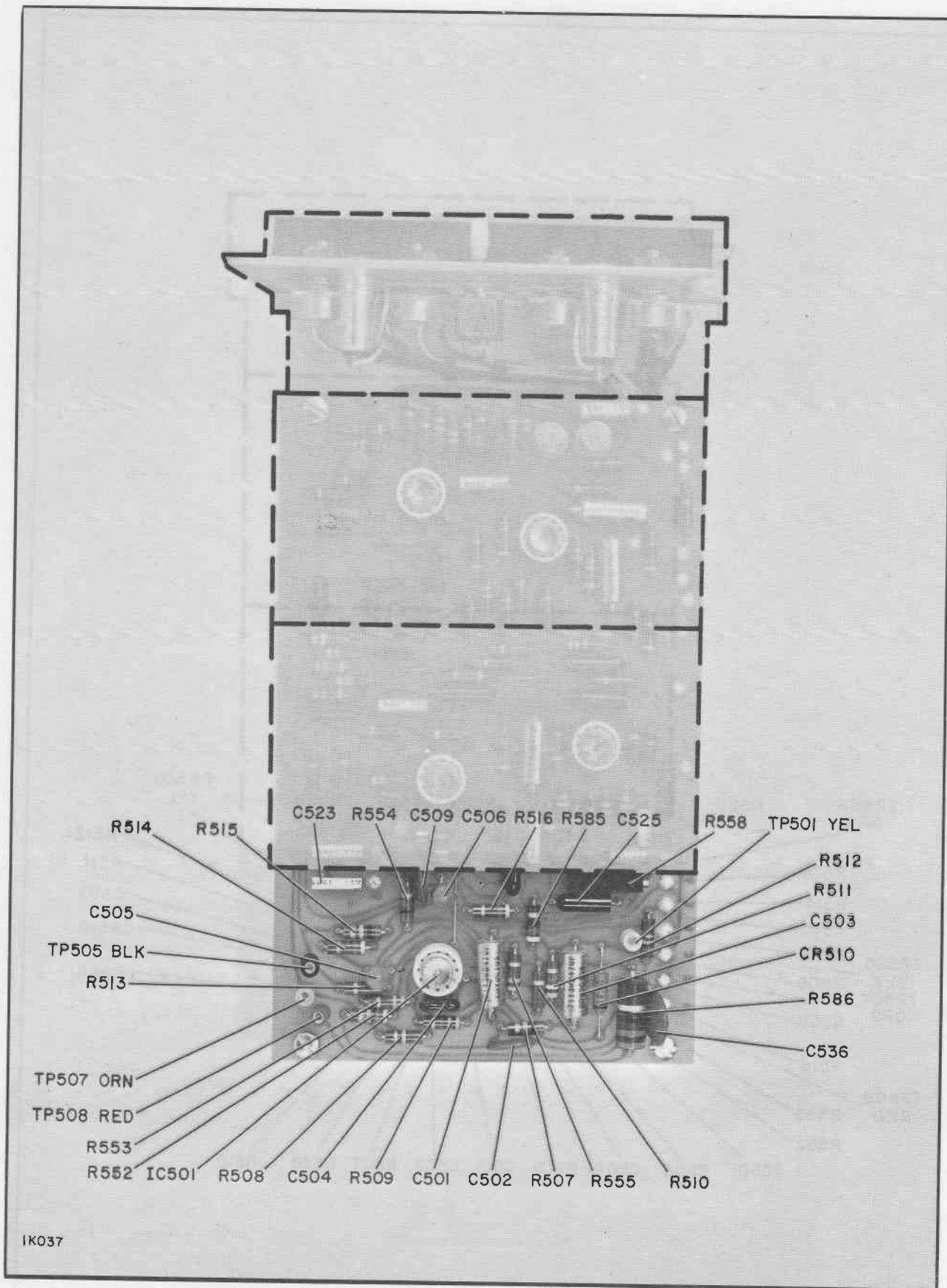

Figure 43a. SCA Generator Board, Parts Location, Ser. No. 1000 and Up

NOTES

REV	DESCRIPTION	BY	DATE	APP'D	DATE	REV	DESCRIPTION	BY	DATE	APP'D	DATE
1	INITIAL										
2	...										
3	...										
4	...										
5	...										
6	...										
7	...										
8	...										
9	...										
10	...										

1. ALL DIMENSIONS ARE IN MILLIMETERS.
 2. DIMENSIONS ARE TO CENTER UNLESS OTHERWISE SPECIFIED.
 3. DIMENSIONS ARE TO CENTER UNLESS OTHERWISE SPECIFIED.
 4. DIMENSIONS ARE TO CENTER UNLESS OTHERWISE SPECIFIED.
 5. DIMENSIONS ARE TO CENTER UNLESS OTHERWISE SPECIFIED.
 6. DIMENSIONS ARE TO CENTER UNLESS OTHERWISE SPECIFIED.
 7. DIMENSIONS ARE TO CENTER UNLESS OTHERWISE SPECIFIED.
 8. DIMENSIONS ARE TO CENTER UNLESS OTHERWISE SPECIFIED.
 9. DIMENSIONS ARE TO CENTER UNLESS OTHERWISE SPECIFIED.
 10. DIMENSIONS ARE TO CENTER UNLESS OTHERWISE SPECIFIED.



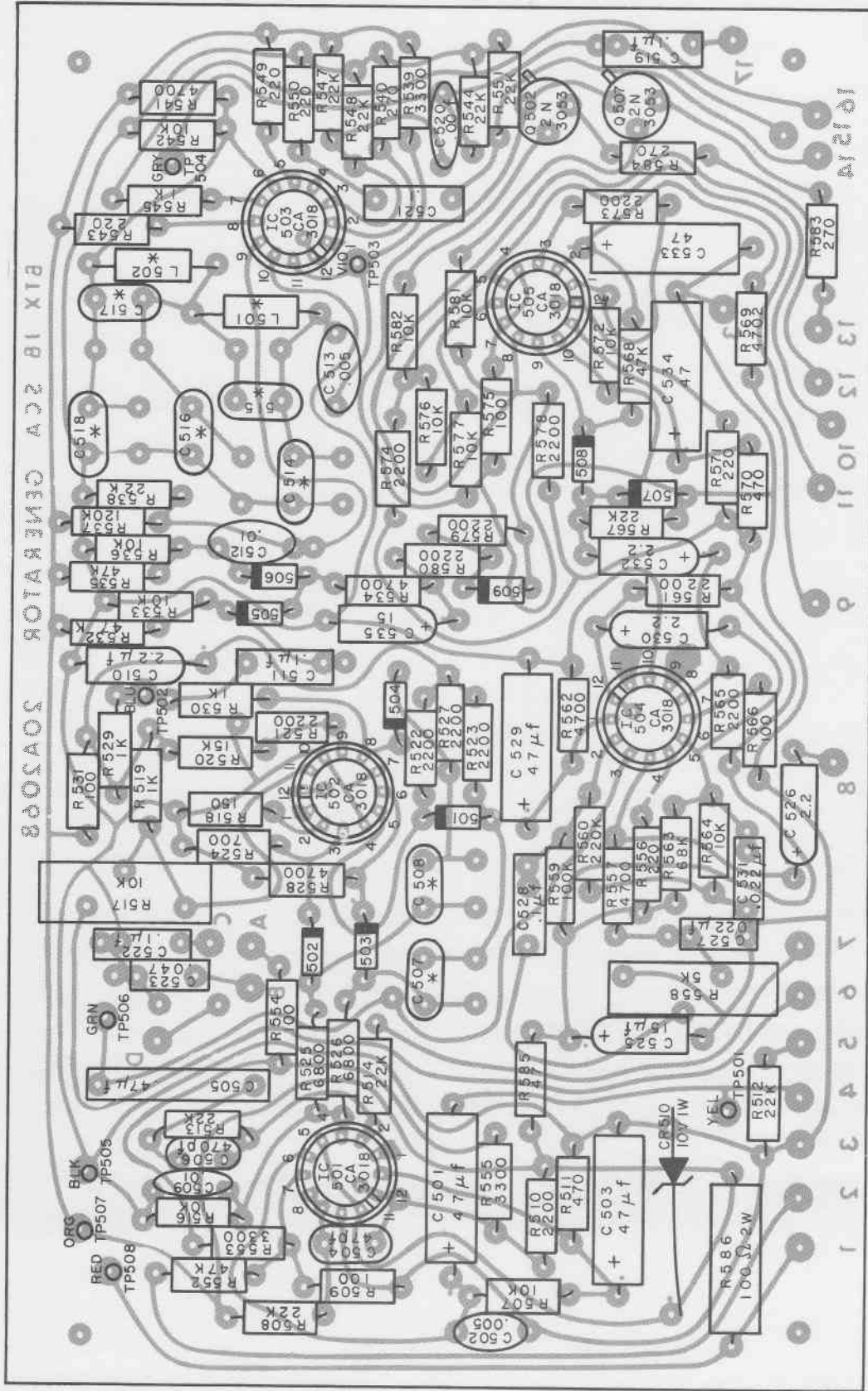

NOTES:

1. UNLESS OTHERWISE SPECIFIED
RESISTOR VALUES ARE IN OHMS, 1/2 W, 10 %
CAPACITOR VALUES ARE IN MICROFARADS.
2. DENOTES IN 5154 DIODE
3. * FREQUENCY DEPENDENT COMPONENT
VALUES.

FREQ.	C 507	C 508	L 501	L 502	C 514	C 515	C 516	C 517	C 518
67 KHZ	820pf	820pf	4700 μH	3900 μH	470 pf	120pf	820pf +120pf	430 pf	820pf
41 KHZ	820pf +560pf	820pf +560pf	10,000 μH	4700 μH	750 pf	150 pf	820pf +820pf	820pf	820pf +560pf

Figure 44. SCA Generator Board, Parts Location, Ser. No. 1 through 999

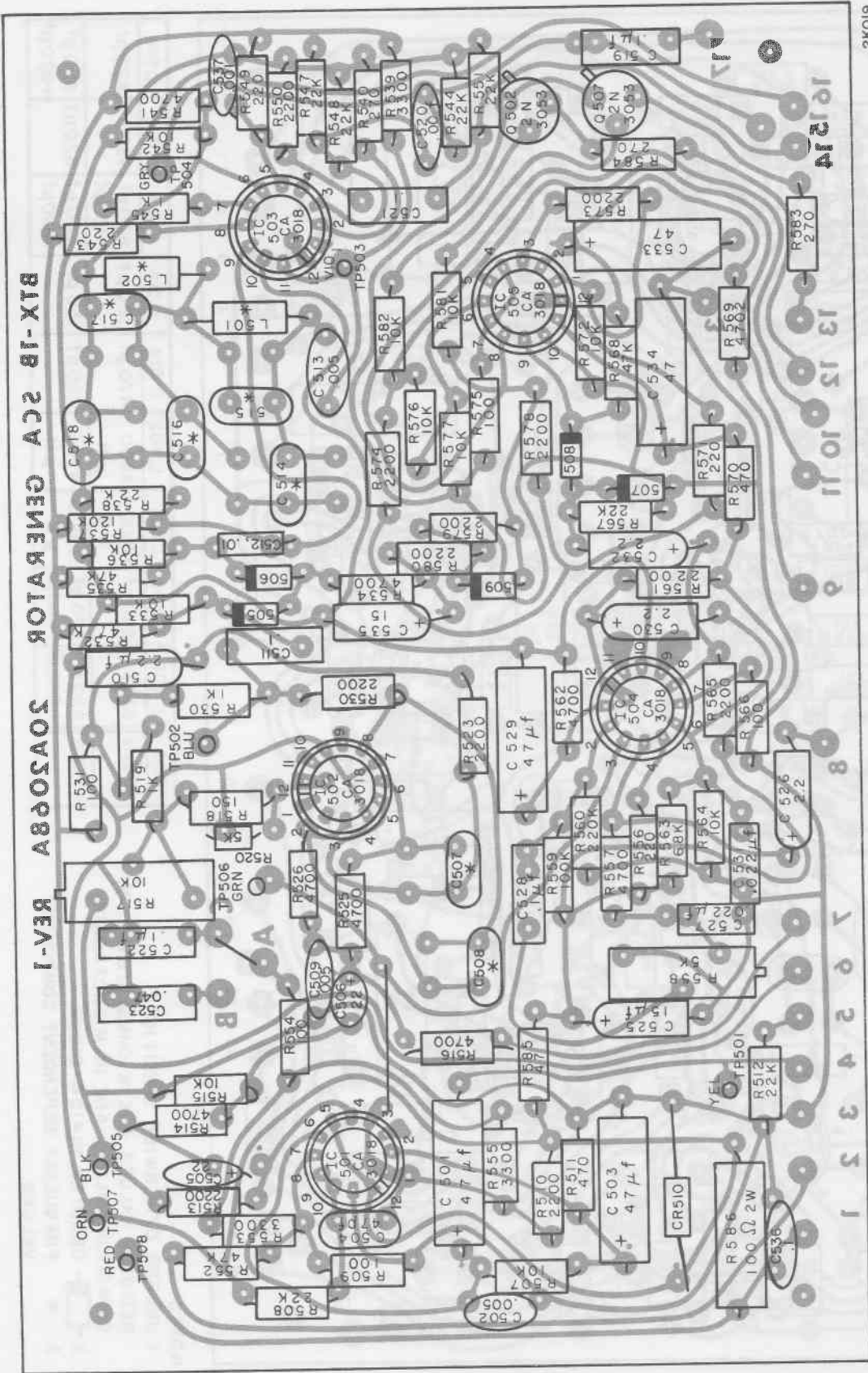

FREQ.	C507#	C508#	L501	C514	C515	C516	C517	C518
67 KHZ	560pf	560pf	4700 μ H	470 pf	120pf	820pf +120pf	430 pf	820pf
41 KHZ	820pf +330pf	820pf +330pf	10,000 μ H	750 pf	150 pf	820pf +820pf	820pf	820pf +560pf

NOMINAL VALUE GIVEN

- NOTES:
1. UNLESS OTHERWISE SPECIFIED RESISTOR VALUES ARE IN OHMS, 1/2 W, 10% CAPACITOR VALUES ARE IN MICROFARADS.
 2. DENOTES IN 5154 DIODE
 3. * FREQUENCY DEPENDENT COMPONENT VALUES

Figure 44a. SCA Generator Board, Parts Location, Ser. No. 1000 and Up

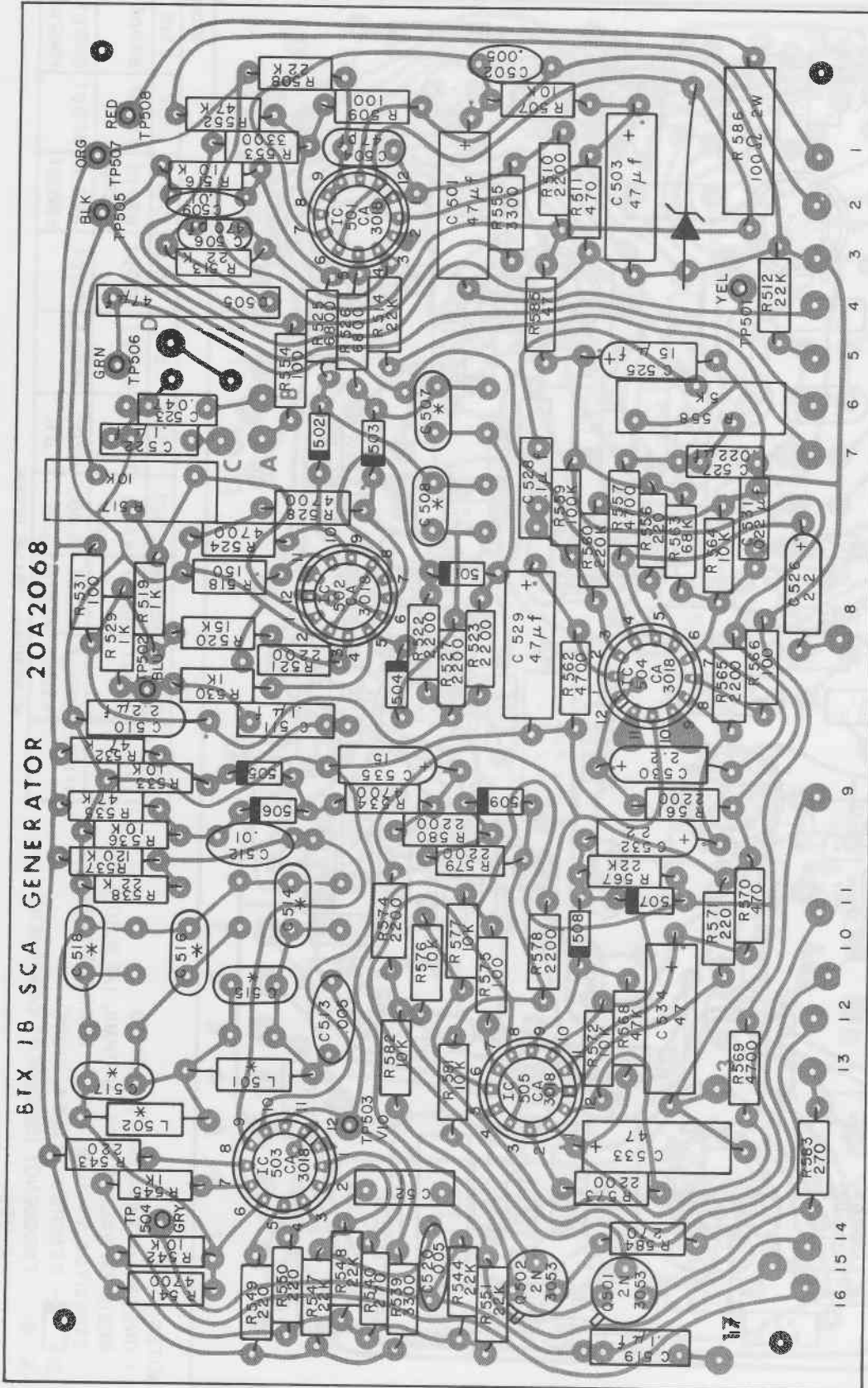

FREQ.	C 507	C 508	L 501	L 502	C 514	C 515	C 516	C 517	C 518
67KHZ	820 pf	820 pf	4700 μH	3900 μH	470 pf	120 pf	820 pf +120pf	430 pf	820 pf
41KHZ	820 pf +560pf	820 pf +560pf	10,000 μH	4700 μH	750 pf	150 pf	820 pf +820pf	820 pf	820 pf +560pf

- NOTES:
- UNLESS OTHERWISE SPECIFIED RESISTOR VALUES ARE IN OHMS, 1/2W, 10% CAPACITOR VALUES ARE IN MICROFARADS.
 - DENOTES IN4154 DIODE
 - * FREQUENCY DEPENDENT COMPONENT VALUES.

Figure 45. SCA Generator Board, Parts Location, Ser. No. 1 through 999

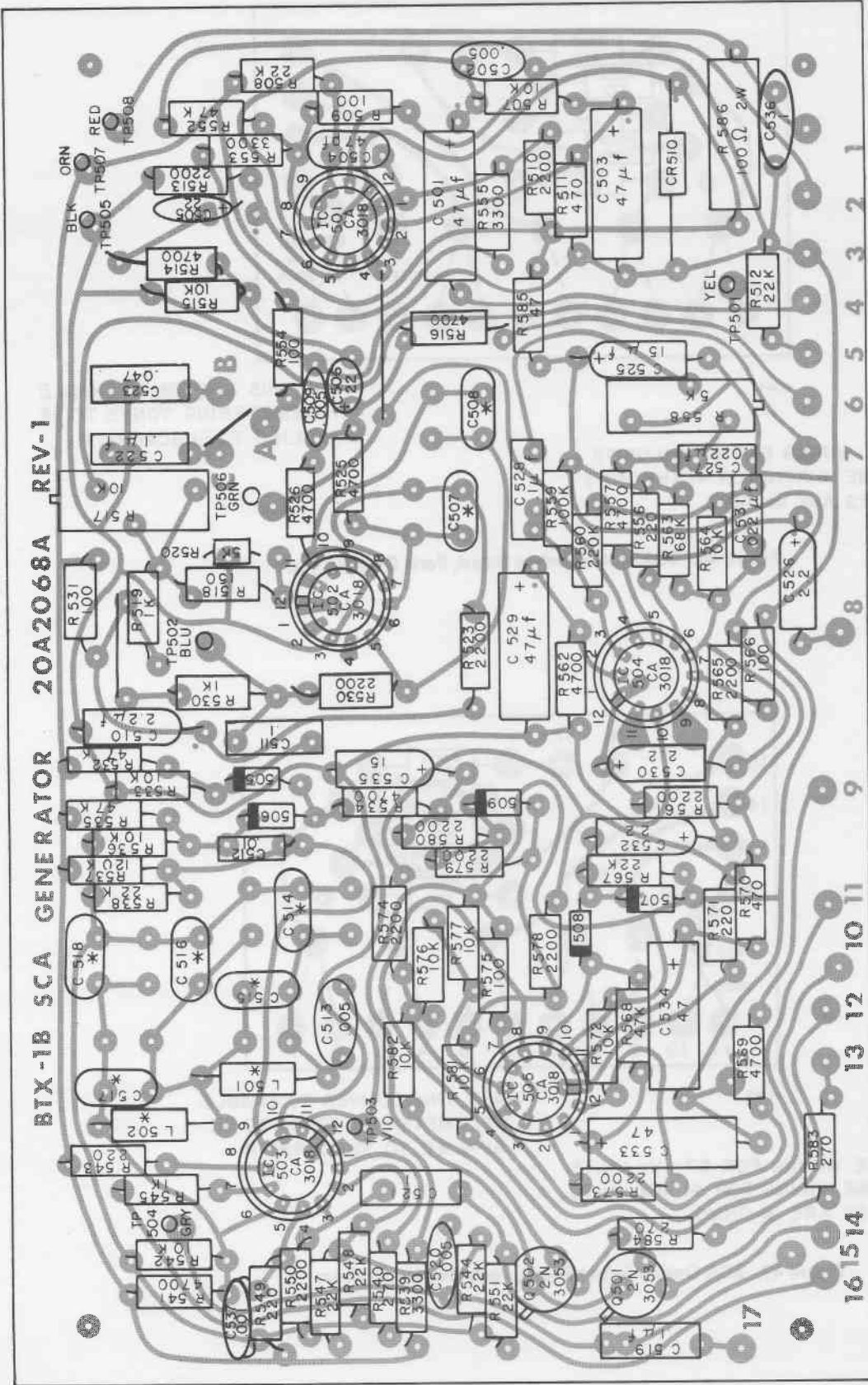

2K020

FREQ.	C507#	C508#	L 501	L 502	C 514	C 515	C 516	C 517	C 518
67KHZ	560 pf	560 pf	4700 μ H	3900 μ H	470 pf	120 pf	820 pf +120pf	C 516	C 518
4.1KHZ	820 pf +330pf	820 pf +330pf	10,000 μ H	4700 μ H	750 pf	150 pf	820 pf +820pf	C 517	C 518

NOMINAL VALUE SHOWN

- NOTES:
1. UNLESS OTHERWISE SPECIFIED RESISTOR VALUES ARE IN OHMS, 1/2 W, 10 % CAPACITOR VALUES ARE IN MICROFARADS.
 2. DENOTES IN 4154 DIODE
 3. * FREQUENCY DEPENDENT COMPONENT VALUES.

Figure 45a. SCA Generator Board, Parts Location, Ser. No. 1000 and Up

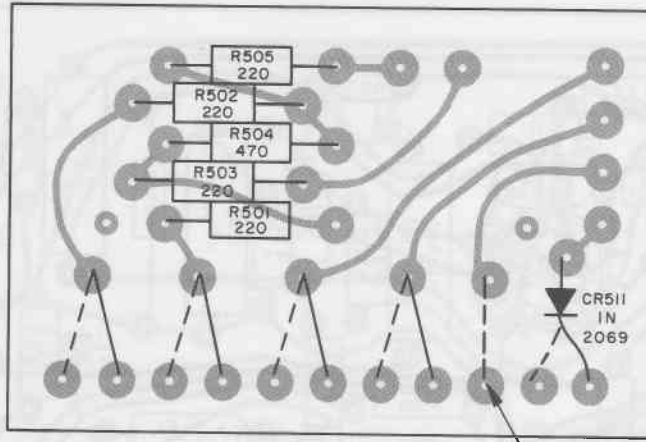

IK144

ADD THIS JUMPER TO ENABLE
TELEMETERING TONES TO BE
APPLIED TO SUBCARRIER

NOTES:

1. USE SOLID LINE WIRING FOR 67 KHz UNITS
USE DOTTED LINE WIRING FOR 41 KHz UNITS
2. RESISTOR VALUES ARE IN OHMS

Figure 46. SCA Option Select Board, Parts Overlay, Top

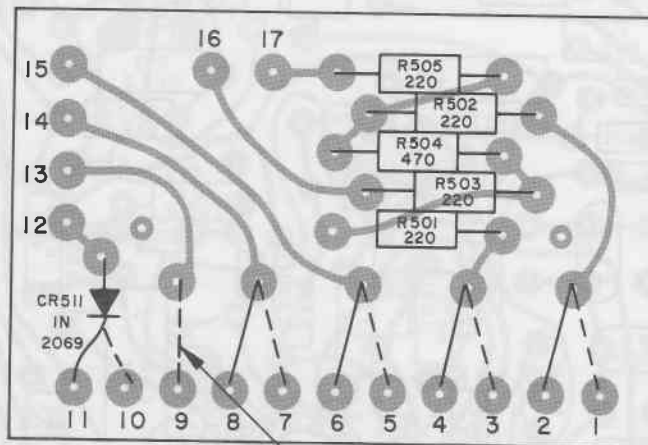

IK145

ADD THIS JUMPER TO ENABLE
TELEMETERING TONES TO BE
APPLIED TO SUBCARRIER

NOTES:

1. USE SOLID LINE WIRING FOR 67 KHz UNITS
USE DOTTED LINE WIRING FOR 41 KHz UNITS
2. RESISTOR VALUES ARE IN OHMS

Figure 47. SCA Option Select Board, Parts Overlay, Bottom

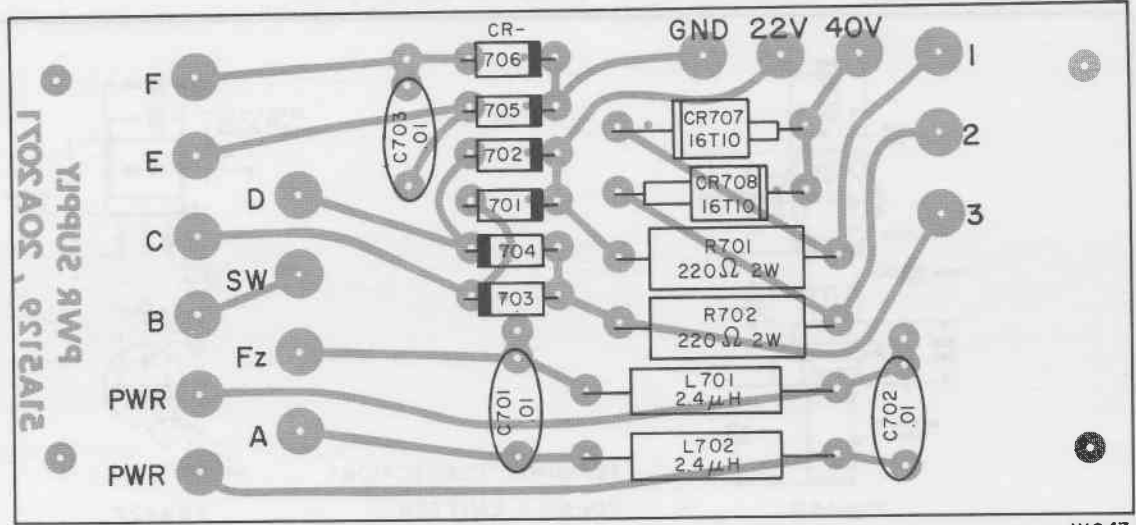

IKO47

NOTES:

1.  DENOTES 10 D2 DIODE
2. UNLESS OTHERWISE SPECIFIED CAPACITOR VALUES ARE IN MICROFARADS

Figure 48. BTS-1B Power Supply Board, Parts Overlay



IKO48

NOTES:

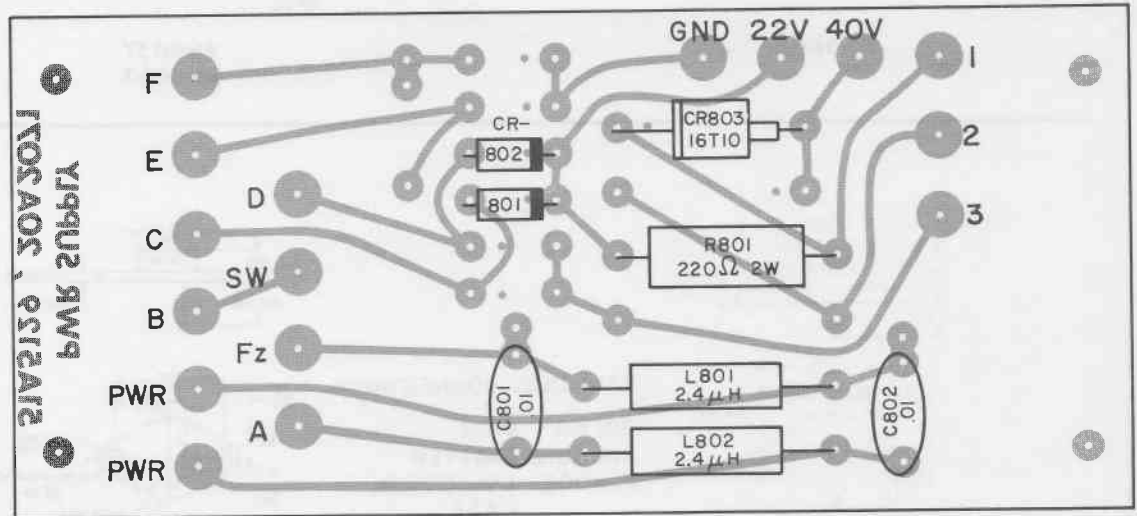
1.  DENOTES 10 D2 DIODE
2. UNLESS OTHERWISE SPECIFIED CAPACITOR VALUES ARE IN MICROFARADS

Figure 49. BTX-1B Power Supply Board, Parts Overlay

SEMICONDUCTOR BASE DATA



2N4440
2N5102

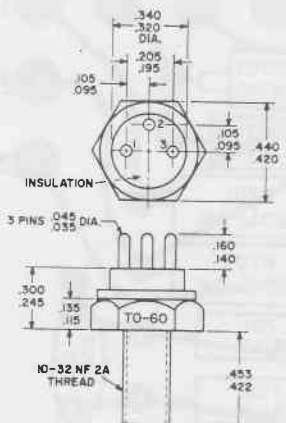
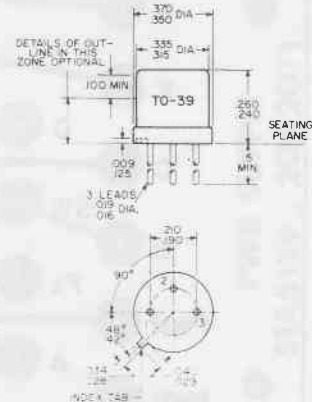

2N4427
2N3866

TERMINAL CONNECTIONS

PIN NO. 1 EMITTER
PIN NO. 2 BASE
PIN NO. 3 COLLECTOR, CASE

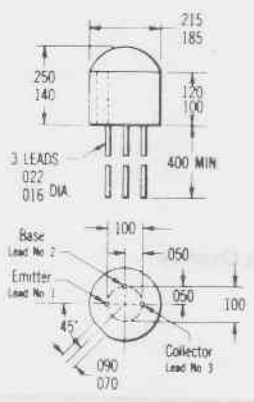

2N3640

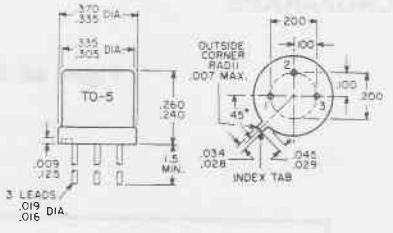

2N4037
2N3053

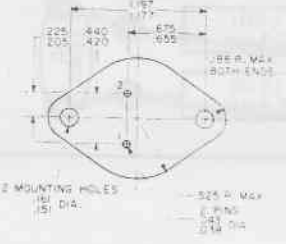
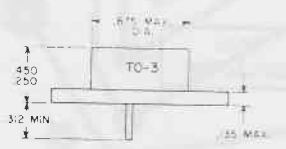

2N3055

TERMINAL CONNECTIONS

PIN NO. 1 BASE
PIN NO. 2 EMITTER
FLANGE COLLECTOR, CASE

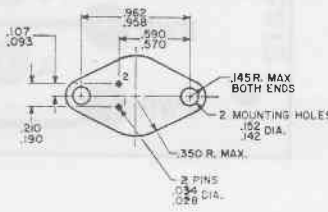
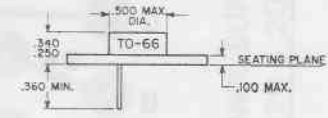

2N3054
2N3740

SEMICONDUCTOR BASE DATA

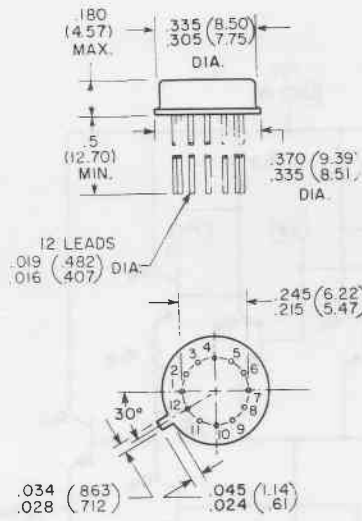

CA 3018
CA 3015

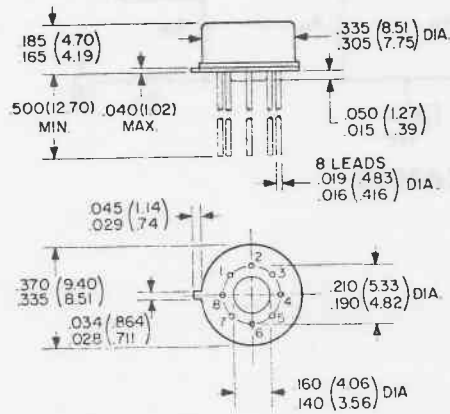

CA 3028

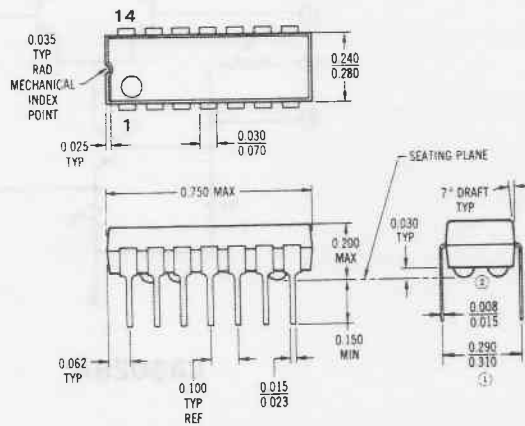

MC1027P
MC1013P
MC890P
MC819P

① This dimension is measured at the seating plane ② 4 insulating stand offs are provided

INTEGRATED CIRCUIT SCHEMATICS

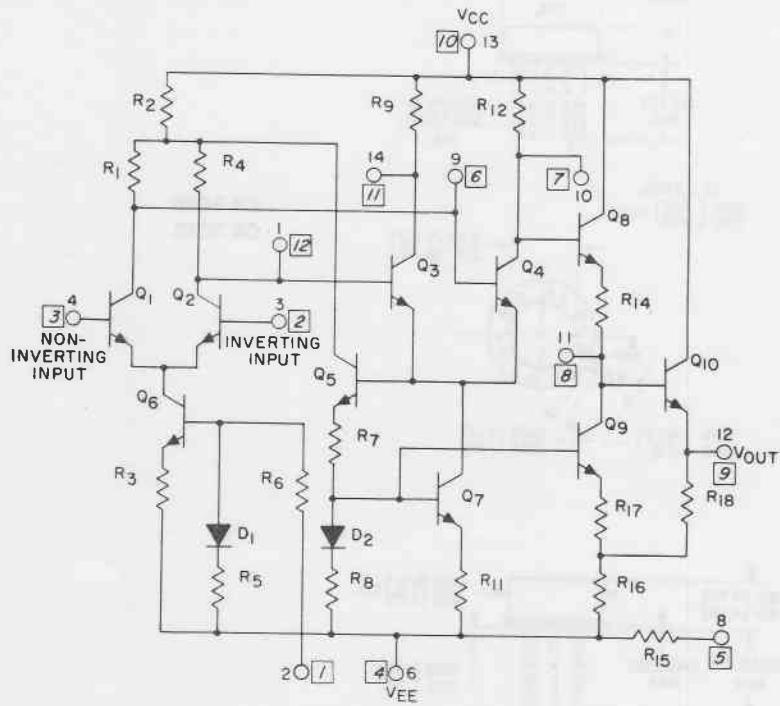

CA3015

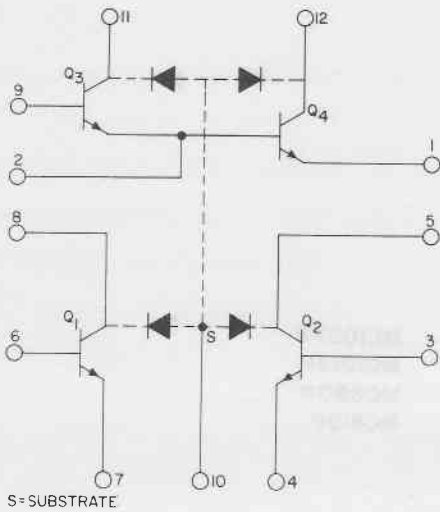

CA3018

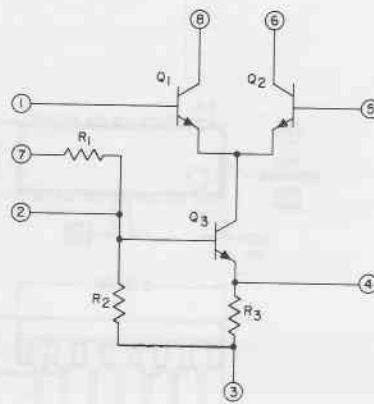

CA3028A

MC790P • MC890P DUAL J-K FLIP-FLOPS

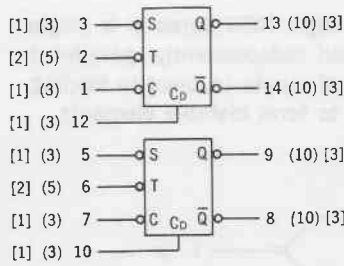

CLOCKED INPUT OPERATION ①

t_n ②		t_{n+1} ③	
S	C	Q	\bar{Q}
1	1	Q_n ③	\bar{Q}_n
1	0	1	0
0	1	0	1
0	0	\bar{Q}_n	Q_n ③

$f_{TQ} = 4 \text{ MHz}$
 $P_D = 182 \text{ mW}$

Two J-K flip-flops in a single package. Each flip-flop has a direct clear input in addition to the clocked inputs.

- Direct input (C_D) must be low.
- The time period prior to the negative transition of the clock pulse is denoted t_n and the time period subsequent to this transition is denoted t_{n+1} .
- Q_n is the state of the Q output in the time period t_n .
- Clock pulse fall time must be $< 100 \text{ ns}$.

NUMBER IN PARENTHESIS INDICATES LOADING FACTOR FOR mW MRTL.
 NUMBER IN BRACKETS INDICATES LOADING FACTOR FOR MRTL.

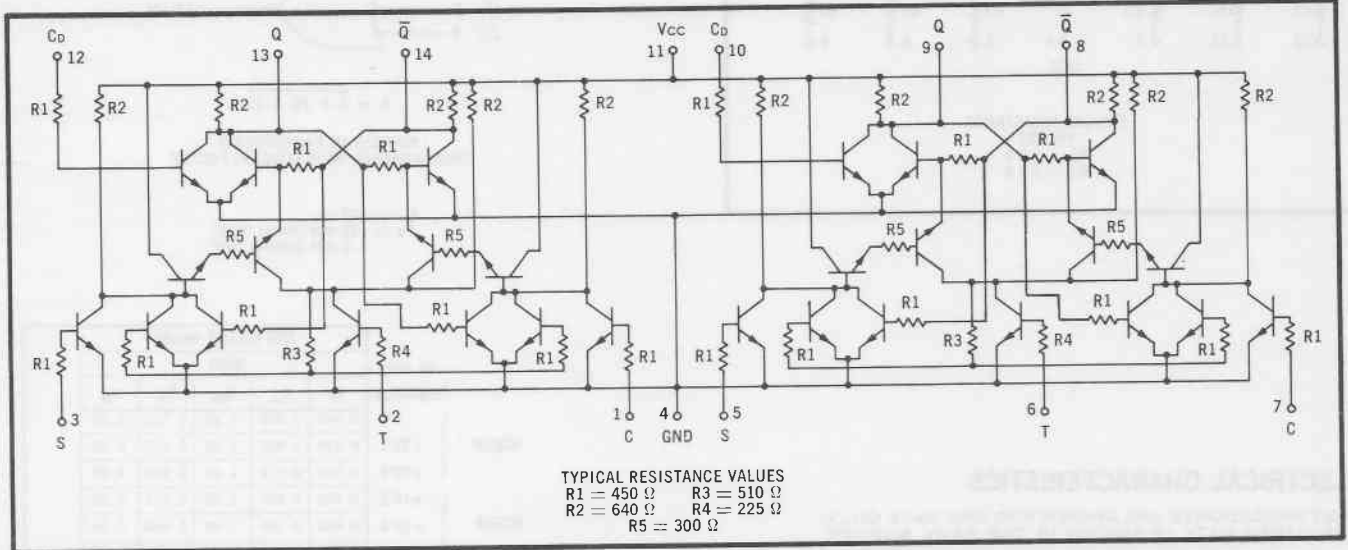

TYPICAL RESISTANCE VALUES
 $R1 = 450 \Omega$ $R3 = 510 \Omega$
 $R2 = 640 \Omega$ $R4 = 225 \Omega$
 $R5 = 300 \Omega$

ELECTRICAL CHARACTERISTICS

TEST PROCEDURES ARE SHOWN FOR ONE FLIP-FLOP ONLY. THE OTHER FLIP-FLOP IS TESTED IN THE SAME MANNER.

@ Test Temperature	TEST VOLTAGE VALUES (Volts)				
	V_{in}	V_{on}	V_{BOT}	V_{off}	V_{CC}
	MC890P	0.960	0.930	1.80	0.570
+25°C	0.910	0.880	1.80	0.500	3.60
+75°C	0.820	0.790	1.80	0.450	3.60
MC790P	0.865	0.865	1.80	0.475	3.60
+25°C	0.850	0.850	1.80	0.460	3.60
+55°C	0.800	0.800	1.80	0.430	3.60

Characteristic	Symbol	Pin Under Test	MC890P Test Limits						MC790P Test Limits						TEST VOLTAGE APPLIED TO PINS LISTED BELOW:							
			0°C		+25°C		+75°C		+15°C		+25°C		+55°C		V_{in}	V_{on}	V_{BOT}	V_{off}	V_{CC}	Gnd		
			Min	Max	Min	Max	Min	Max	Unit	Min	Max	Min	Max	Min	Max	Unit						
Input Current	I_{in}	1	-	600	-	600	-	570	$\mu\text{A dc}$	-	500	-	500	-	470	$\mu\text{A dc}$	1	-	13	-	11	2, 3, 4, 12
		2	-	1200	-	1200	-	1140		-	1000	-	1000	-	940		2	-	1, 3	-		4, 12
		3	-	600	-	600	-	570		-	500	-	500	-	470		3	-	14	-		1, 2, 4, 12
		12	-	600	-	600	-	570		-	500	-	500	-	470		12	-	14	-		1, 2, 3, 4
Output Current	$I_{A3} \S$	13	1.80	-	1.80	-	1.71	mA dc	1.65	-	1.65	-	1.56	mA dc	-	-	13	1	12	11	2, 3, 4	
		14	-	-	-	-	-	-	-	-	-	-	-	-	-	-	14	3, 12	-	-	1, 2, 4	
		14	-	-	-	-	-	-	-	-	-	-	-	-	-	-	12, 14	3	-	-	1, 2, 4	
		14	-	-	-	-	-	-	-	-	-	-	-	-	-	-	-	-	-	-	-	
Output Voltage	V_{out}	13	-	500	-	400	-	400	mV dc	400	-	300	-	320	mV dc	-	12	-	-	11	1, 2, 3, 4, 14	
		13*#	-	-	-	-	-	-	-	-	-	-	-	-	-	-	1, 3	-	-	-	4, 12	
		13**	-	-	-	-	-	-	-	-	-	-	-	-	-	-	1	-	3	-	-	
		13***	-	-	-	-	-	-	-	-	-	-	-	-	-	-	-	-	-	1, 3	-	-
		14**	-	-	-	-	-	-	-	-	-	-	-	-	-	-	1, 3	-	1	-	-	-
		14*#	-	-	-	-	-	-	-	-	-	-	-	-	-	-	3	-	1, 3	-	-	-
Saturation Voltage	$V_{CE(sat)}$	13	-	400	-	300	-	350	mV dc	-	300	-	290	-	320	mV dc	-	-	12	-	11	1, 2, 3, 4, 14
		13#	-	-	-	-	-	-	-	-	-	-	-	-	-	-	-	-	-	-	-	1, 2, 3, 4, 12
		13##	-	-	-	-	-	-	-	-	-	-	-	-	-	-	-	-	-	-	-	1, 2, 3, 4
		14##	-	-	-	-	-	-	-	-	-	-	-	-	-	-	-	-	-	-	-	-

Ground unused input pins. Other pins not listed are left open.
 * Pin 13 = LOW } Set by a momentary ground prior to the application of the negative-going Clock Pulse.
 ** Pin 14 = LOW }
 § I_{A10} is symbol for MC790P.

MC718P • MC818P DUAL 3-INPUT GATES

MCT718P • MC818P DUAL 3-INPUT GATES

Two 3-input positive logic NOR gates in a single package. Each may be used independently, paralleled for increasing the number of inputs (subject to loading rules), or cross-connected to form bistable elements.

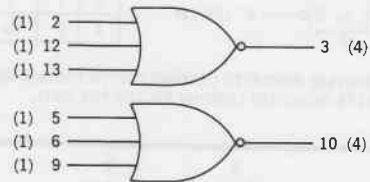
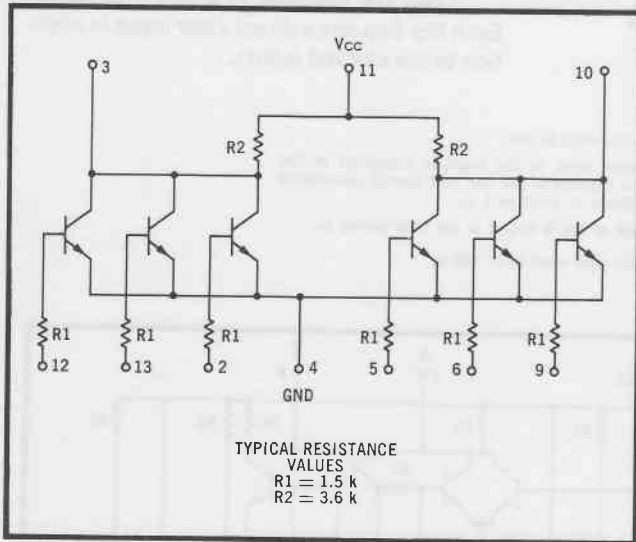

$$3 = 2 + 12 + 13$$

NUMBER IN PARENTHESIS INDICATES mW MRTL LOADING FACTOR

$t_{pd} = 27$ ns
 $P_D = 12$ mW (Input High)
 6 mW (Inputs Low)

ELECTRICAL CHARACTERISTICS

TEST PROCEDURES ARE SHOWN FOR ONE GATE ONLY. THE OTHER GATE IS TESTED IN THE SAME MANNER.

	@ Test Temperature	TEST VOLTAGE VALUES (Volts)				
		V_{in}	V_{on}	V_{BOT}	V_{off}	V_{CC}
MC818P	0°C	0.880	0.850	1.80	0.500	3.60
	+25°C	0.830	0.800	1.80	0.460	3.60
	+75°C	0.740	0.710	1.80	0.400	3.60
MC718P	+15°C	0.865	0.865	1.80	0.475	3.60
	+25°C	0.850	0.850	1.80	0.460	3.60
	+55°C	0.800	0.800	1.80	0.430	3.60

Characteristic	Symbol	Pin Under Test	MC818P Test Limits						MC718P Test Limits						TEST VOLTAGE APPLIED TO PINS LISTED BELOW:							
			0°C		+25°C		+75°C		+15°C		+25°C		+55°C		V_{in}	V_{on}	V_{BOT}	V_{off}	V_{CC}	Gnd		
			Min	Max	Min	Max	Min	Max	Min	Max	Min	Max	Min	Max	Unit	Min	Max	Min	Max	Min	Max	
Input Current	I_{in}	2, 12, 13	-	150	-	140	-	140	μ Adc	-	150	-	150	-	150	μ Adc	2, 12, 13	-	12, 13, 2, 13, 2, 12	-	11	4
Output Current	I_{A4}	3	570	-	570	-	535	-	μ Adc	570	-	570	-	570	-	μ Adc	3	-	-	2, 12, 13	11	4
Output Voltage	V_{out}	3, 3, 3	-	400	-	350	-	300	mVdc	-	400	-	300	-	320	mVdc	-	12, 13, 2	-	-	11	2, 4, 13, 4, 12, 13
Saturation Voltage	$V_{CE(sat)}$	3, 3, 3	-	250	-	250	-	250	mVdc	-	220	-	230	-	320	mVdc	-	-	12, 13, 2	-	11	2, 4, 13, 2, 4, 12, 4, 12, 13
Switching Time	$t_{on} + t_{off}$	3, 13	-	-	-	90	-	-	ns	-	-	-	90	-	-	ns	Pulse In, Pulse Out	13, 3	-	-	11	2, 4, 12

Ground unused input pins. Other pins not listed are left open.

SWITCHING TIMES TEST CIRCUIT AND WAVEFORMS

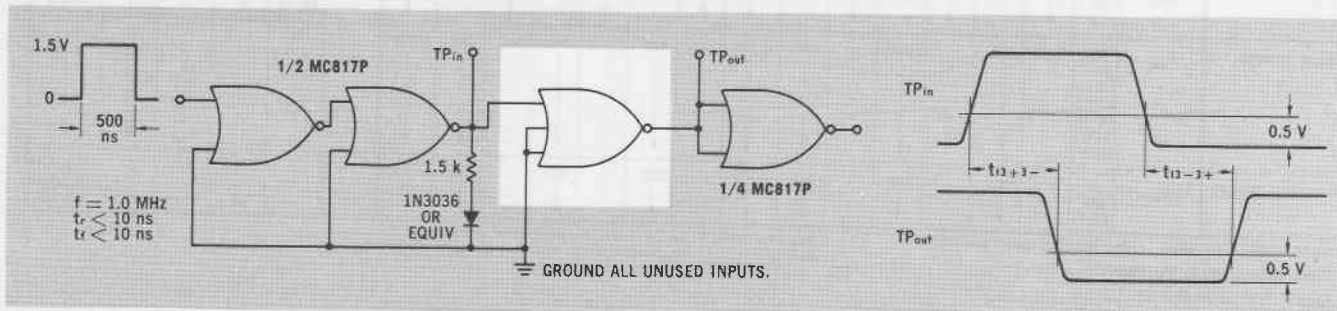

MC1013 85-MHz AC-COUPLED MC1213 J-K FLIP-FLOPS

Designed for use at clock frequencies to 70 MHz minimum (85 MHz typical). Logic performing inputs (\bar{J} and \bar{K}) are available, as well as dc SET and RESET inputs.

POSITIVE LOGIC

DC Input Loading Factor = 1
DC Output Loading Factor = 25
Power Dissipation = 125 mW typical

* Any \bar{J} or \bar{K} Input, not used for \bar{C}_D .
** \bar{C}_D obtained by connecting one \bar{J} and one \bar{K} input together.

The \bar{J} and \bar{K} inputs refer to logic levels while the \bar{C}_D input refers to dynamic logic swings. The \bar{J} and \bar{K} inputs should be changed to a logical "1" only while the \bar{C}_D input is in a logic "1" state. (\bar{C}_D maximum "1" level = $V_{CC} - 0.6$ V). Clock \bar{C}_D is obtained by tying one \bar{J} and one \bar{K} input together.

R-S TRUTH TABLE

R	S	Q^{n+1}
12	2	13
0	0	Q^n
0	1	1
1	0	0
1	1	N.D.

Pin No. All \bar{J} - \bar{K} Inputs Are Static

\bar{J}_D - \bar{K}_D TRUTH TABLE

\bar{J}_D	\bar{K}_D	Q^{n+1}
*	*	13
0	0	Q^n
0	1	0
1	0	1
1	1	\bar{Q}^n

Pin No. All Other \bar{J} - \bar{K} Inputs And The R-S Inputs Are At a "0" Level

CLOCKED \bar{J} - \bar{K} TRUTH TABLE

\bar{J}	\bar{K}	\bar{C}_D	Q^n
*	*	**	13
ϕ	ϕ	0	Q^n
0	0	1	\bar{Q}^n
0	1	1	1
1	0	1	0
1	1	1	Q^n

Pin No. All Other \bar{J} - \bar{K} Inputs And The R-S Inputs Are At a "0" Level

CIRCUIT SCHEMATIC

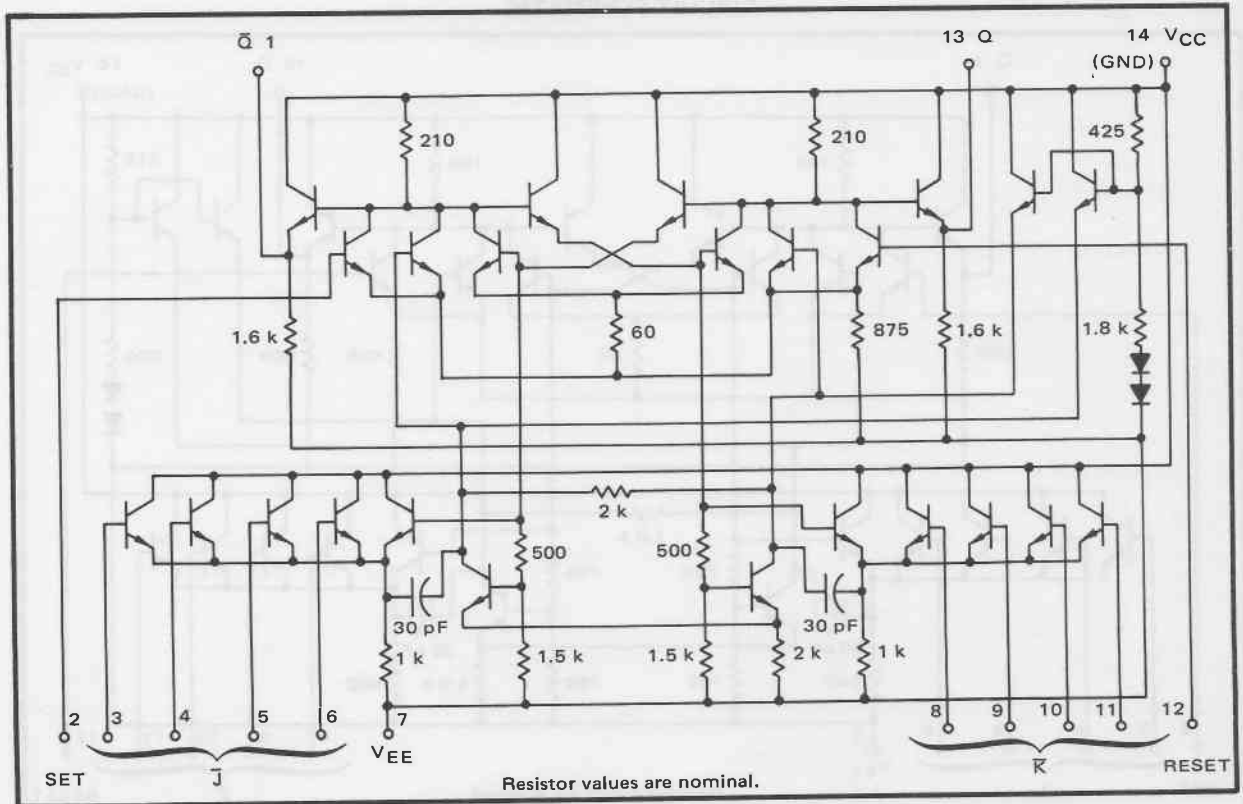

MC1027 120-MHz AC-COUPLED J-K FLIP-FLOP

Designed for use at clock frequencies to 100 MHz minimum (120 MHz typical). Logic performing inputs (\bar{J} and \bar{K}) are available, as well as dc SET and RESET inputs.

POSITIVE LOGIC

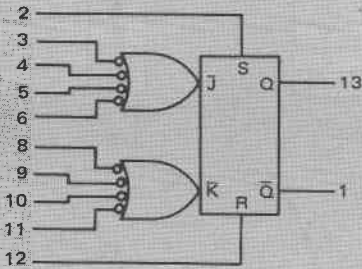

DC Input Loading Factor = 2
 DC Output Loading Factor = 25
 Power Dissipation = 250 mW typical

- * Any \bar{J} or \bar{K} Input, not used for \bar{C}_D .
- ** \bar{C}_D obtained by connecting one \bar{J} and one \bar{K} input together.

The \bar{J} and \bar{K} inputs refer to logic levels while the \bar{C}_D input refers to dynamic logic swings. The \bar{J} and \bar{K} inputs should be changed to a logical "1" only while the \bar{C}_D input is in a logic "1" state. (\bar{C}_D maximum "1" level = $V_{CC} - 0.6$ V). Clock \bar{C}_D is obtained by tying one \bar{J} and one \bar{K} input together.

R-S TRUTH TABLE

R	S	Q^{n+1}
0	0	Q^n
0	1	1
1	0	0
1	1	N.D.

All J-K Inputs Are Static

\bar{J}_D - \bar{K}_D TRUTH TABLE

\bar{J}_D	\bar{K}_D	Q^{n+1}
*	*	13
0	0	Q^n
0	1	0
1	0	1
1	1	\bar{Q}^n

All Other J-K Inputs And The R-S Inputs Are At a "0" Level

CLOCKED \bar{J} - \bar{K} TRUTH TABLE

J	\bar{K}	\bar{C}_D	Q^n
*	*	**	13
ϕ	ϕ	0	Q^n
0	0	1	\bar{Q}^n
0	1	1	1
1	0	1	0
1	1	1	Q^n

All Other J-K Inputs And The R-S Inputs Are At a "0" Level

CIRCUIT SCHEMATIC

