



Class A plate current
is constant

" B more e volts
plate current is
near zero
Modulation drive
plate current to
high value

High Fidelity

Class "C" Only for R-F
Amplification
when power needs
grid - double
the grid bias
battery

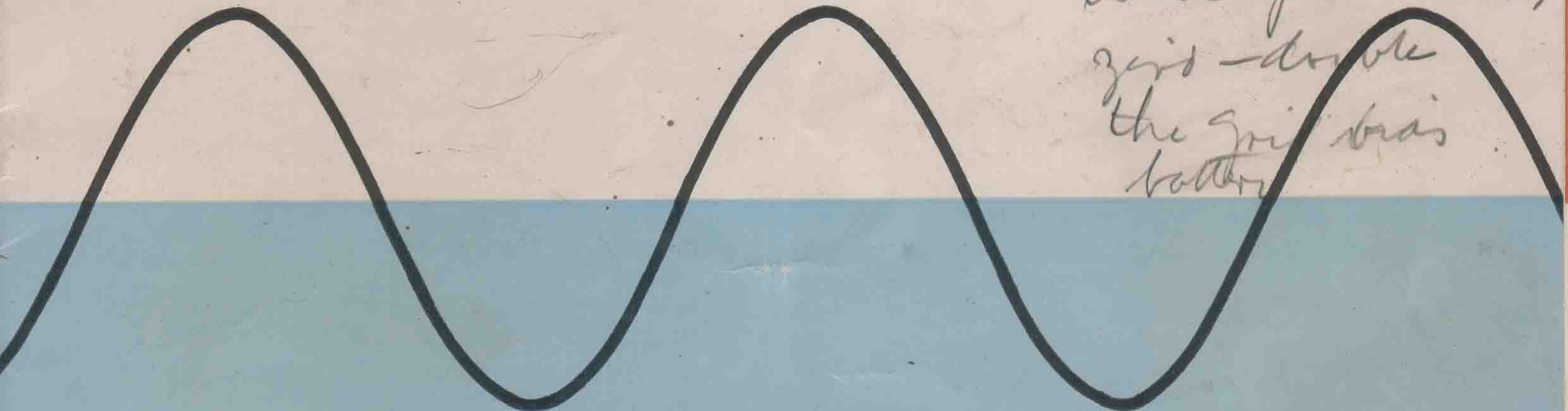

SPEECH EQUIPMENT

[Faint, illegible handwritten notes at the bottom of the page.]

IT is the purpose of this booklet to discuss briefly the technical requirements imposed by modern standards of fidelity in sound transmission and to describe apparatus developed by the COLLINS RADIO COMPANY to meet these requirements.

Obviously the most important requirement for high fidelity is the ability of the apparatus to transmit a wide frequency range. Of course, the illusion of "good tone quality" may be created by apparatus responding only to frequencies between approximately 100 and 4000 cycles. There are several reasons for this. The ear has a tendency to compensate for the poor response of the apparatus, for in the case of a musical tone consisting of a fundamental and a series of over-tones, the ear recognizes pitch not by the frequency of the lowest or fundamental tone, but by the difference in frequency between successive over-tones. Thus the ear may supply frequencies which are entirely missing in the output of the loudspeaker. However, these tones, as reconstructed by the ear, lack depth and the impression of reality.

The frequencies above 5000 cycles do not add greatly to the quality of music or to the understandability of speech, but they are essential in creating the effect of "presence" and reality in the reproduction. Tests have shown that, although the entire audible band out to 16,000 or 18,000 cycles may be desirable in some cases, considerations of background noise, absorption, and other factors place the desirable upper limit at about 10,000 cycles in most cases. The differ-

ence in naturalness which is apparent when the octave above 10,000 cycles is added can be distinguished only by a trained observer under ideal conditions. Therefore the frequency range from 30 or 50 cycles to 10,000 cycles may be considered as sufficiently wide for most practical applications.

Besides the desirability for a wide frequency range, it is of equal or greater importance that this entire band of audio frequencies be carried with neither peaks nor discrimination between frequencies. Since the human ear is the ultimate judge in every case, the practical limit of this variation is set as the minimum which can be noted by the ear. Considering the entire range of frequencies at normal volume of reproduction, a change in amplitude of 2 decibels is scarcely noticeable. Therefore, the maximum variation over the above band of frequencies must not be greater than plus or minus one decibel.

Another requirement is the necessity for a wide volume range. Orchestral music, for example, sometimes varies 60 or 70 decibels in intensity and if the reproduced music is to approximate the original, the amplifying and reproducing apparatus must at least approach this figure in its power handling capabilities. Due to the laxity of the human ear, this complete volume range is not entirely necessary, nor is it always desirable to reproduce at the volume level of the original. However, it is generally agreed that a volume range of at least 40 decibels is necessary.

This wide volume range imposes two additional requirements on the system; namely, that the power handling ability must be great enough to accommodate the highest power likely to be encountered, and, second, the noise introduced in the equipment itself must be so far below the program level that it is negligible in comparison with the minimum signal to be handled. The first requirement is easily satisfied, but the solution of the latter is not so easy. The construction of a noise-free amplifier requires very careful research and engineering. Present day resistors, condens-

ers, and other parts are practically noise-free for ordinary applications, so the major cause of noise in a. c. operated amplifiers is hum. This can be reduced by careful design to a point where it is entirely negligible, even in amplifiers having as high as 120 decibels gain, and having an integral power supply. The residual noise level of a system should be from 50 to 70 decibels below the program level.

Listening tests have shown that while a total harmonic content of 10% is detectable by critical observers, it is not at all apparent to the average listener. However, since it is not a difficult matter to build audio apparatus with distortion much lower than this, it is desirable to hold the total harmonic content for the whole system to a low figure, preferably below 5%.

Collins Series 12 High Fidelity Speech Equipment

With the realization that these requirements will become increasingly important as the public becomes cognizant of the advantages of high fidelity reproduction, the **Collins Radio Company** has developed a line of truly high fidelity audio apparatus. The **Collins' Series 12** speech equipment meets an urgent demand for fine high-fidelity studio amplifying and control equipment, possessing the additional feature of complete a. c. operation, easy installation and utmost flexibility. The standard arrangements comprise the apparatus necessary to control various microphones, phonograph pickups, telephone lines, etc. and to amplify their outputs sufficiently to feed a program line or the modulators of a radio transmitter.

The Block diagrams (pages 4, 5 and 6) show typical **Series 12** arrangements. The standard amplifiers are normally furnished with jack or terminal strip inputs for use with crystal type microphones, although inputs for moving coil or velocity type microphones can be furnished. Mixing is done at a relatively high level and the channels may be controlled either by means of locking type key switches or by relays with push

To summarize, then, an amplifying system to be capable of high fidelity performance must have the following characteristics:

- (1) It must respond to frequencies from 30 to 10,000 cycles or beyond. The upper limit may be 15,000 cycles under certain conditions.
- (2) The maximum variation over this range should be not more than plus or minus one decibel.
- (3) The dynamic power range should be at least 40 decibels.
- (4) The residual hum and noise introduced by the system must be at least 50 to 70 decibels below program level.
- (5) The total harmonic content must be below 5%.

button controls both at the speech rack and at as many remote points as may be desired. Pilot lights are provided at all control points to indicate which channels are in operation.

GENERAL SPECIFICATIONS

Frequency Response: Plus or minus one decibel from 30 to 10,000 cycles per second (extended range is available on special order).

Dynamic Power Range: 50 decibels.

Residual Hum: Minus 65 decibels below program level.

Power Output: Plus 32 decibels. (Zero reference: 6 milliwatts).

Harmonic Distortion: Less than 3 percent at plus 32 decibels.

The **Collins' Series 12** speech equipment has been designed to meet all the modern requirements of high-fidelity, quality and reliability. Although the equipment is well standardized, the arrangement may, if necessary, be altered in individual cases to take care of special conditions, so that the purchaser is assured of having speech equipment which will best satisfy his present and future needs.

COLLINS SERIES 12

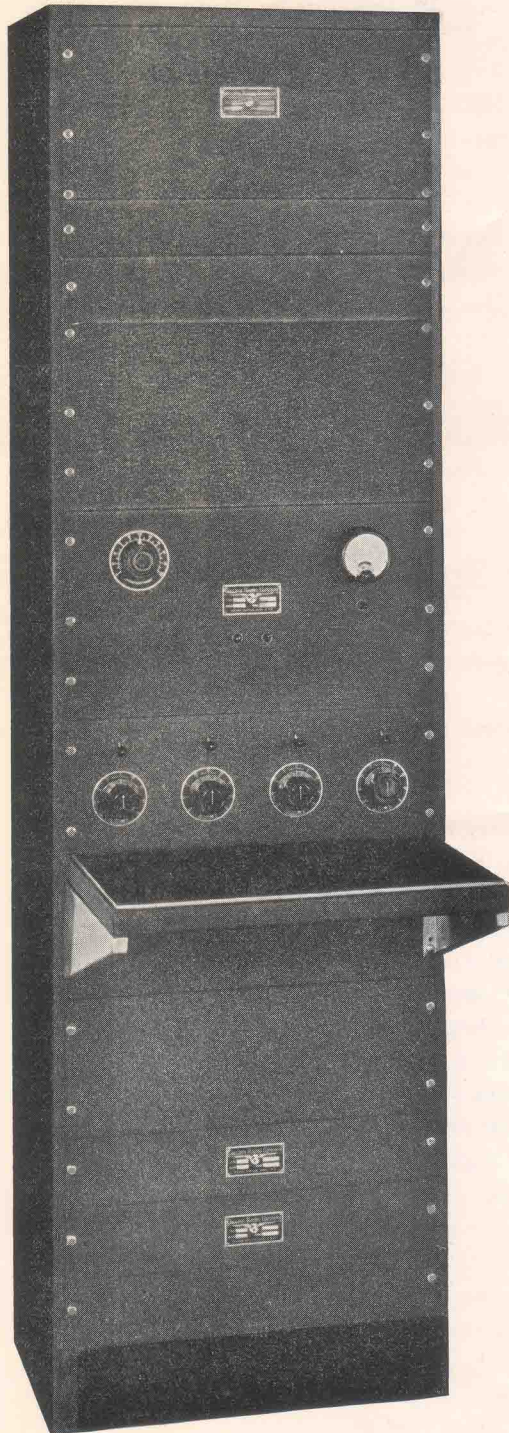

TYPE 12A

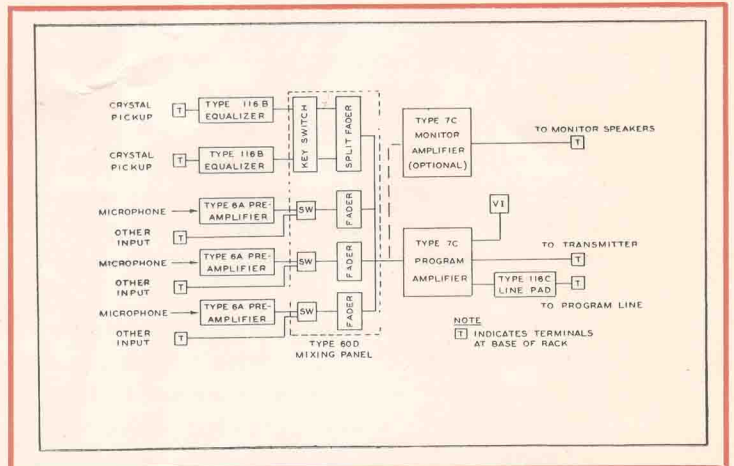

Block Diagram showing a typical 12A assembly

Type 12A •

The TYPE 12A Speech Rack comprises the equipment necessary to control three microphones of the crystal, dynamic or velocity type, two crystal pickups and three additional 500 ohm inputs. Mixing is done at a relatively high level by means of the TYPE 60D Mixing Panel. The attenuators are of the noiseless ladder type. The key switches in each channel are of the two position, locking type, serving to select either of two inputs to the channel, or to open the channel entirely without rotating the faders.

A split fader is provided for fading the outputs of two crystal pickups and their associated TYPE 116B Equalizers into the program channel. An additional TYPE 7C Amplifier may be bridged across the output of the TYPE 60D Mixer for monitoring or standby use. All external connections are made to a shielded terminal strip at the base of the rack. The TYPE 12A can be used either to feed a program line or to drive a transmitter at levels up to plus 32 decibels without auxiliary equipment.

The TYPE 12A Speech Rack includes the following units:

- 1—TYPE 7C Amplifier with terminal input and volume indicator
- 3—TYPE 6A Pre-amplifiers with jack input and 500 ohm output
- 1—TYPE 60D Four-position Mixing Panel
- 2—TYPE 116B Phono-equalizers
- 1—TYPE 116C Line Pad (20 db.)
- 3—TYPE 225B Repeat Coils
- 1—TYPE 151A Terminal Strip with Cover
- 1—110 V. fuse block

—completely assembled with shielded cable and mounted in a TYPE 19A black crinkled rack cabinet with door and arm rest.

TYPE 12A Speech Rack, code word: YAPOK

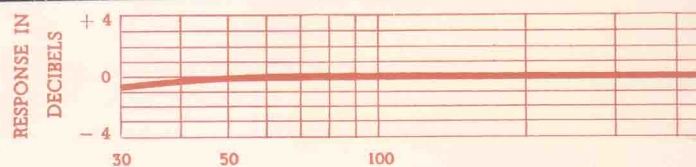

TYPICAL FREQUENCY CHARACTERISTIC CURVE

SPEECH EQUIPMENT

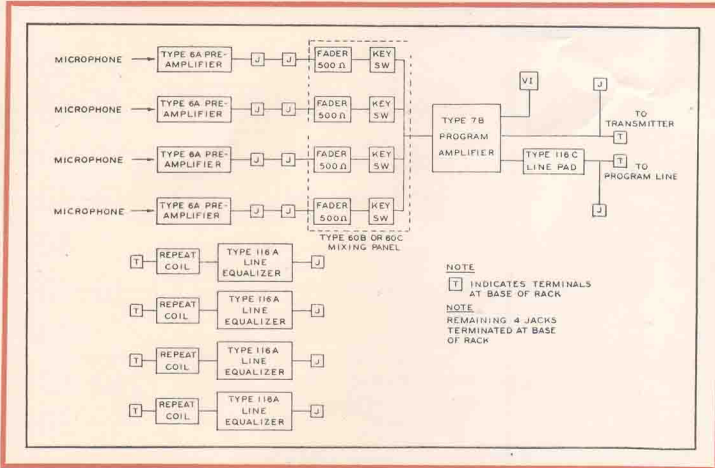

Block Diagram showing a typical 12B assembly

Type 12B •

The TYPE 12B Speech Rack is very similar to the type 12A Speech rack except that a slightly different amplifier and mixing system are employed. The equipment necessary to control four microphones, four equalized remote lines, and four additional lines or other 500 ohm inputs is included. The TYPE 6A Pre-amplifiers can be furnished either with jack input for crystal microphone or with shielded input transformers for low impedance microphones. Mixing is done at a relatively high level by means of either the TYPE 60B or the TYPE 60C mixing panels. The attenuators in both cases are of the noiseless ladder type with an attenuation of 1 decibel per step. In the TYPE 60B, key switches are provided to instantly cut each channel in or out without rotating the fader. The TYPE 60C is identical to the TYPE 60B, except that instead of using key switches to control each channel, relays are used with push button control at the speech rack and at as many remote points as may be desired. Pilot lights are provided at all control points. All external connections are made to a shielded terminal strip at the base of the rack. The TYPE 12B can be used either to feed a program line or to drive a transmitter at levels up to plus 32 decibels without auxiliary equipment.

The TYPE 12B Speech Rack includes the following units.

- 1—TYPE 7B Program Amplifier with volume indicator
 - 4—TYPE 6A Pre-amplifier with jack inputs and 500 ohm outputs
 - 1—TYPE 60B or 60C Four-position Mixing Panel
 - 4—TYPE 116A Line Equalizers
 - 1—TYPE 116C Line Pad
 - 4—TYPE 225B Repeat Coils
 - 1—TYPE 265A Jack Strip
 - 4—TYPE 211A Patch Cords
 - 1—TYPE 151A Terminal Strip with Cover
 - 1—110 V. fuse block
- completely assembled with cable and mounted in a TYPE 19A black crinkled rack cabinet with door and arm rest.

TYPE 12B Speech Rack, Code word: YAPKO

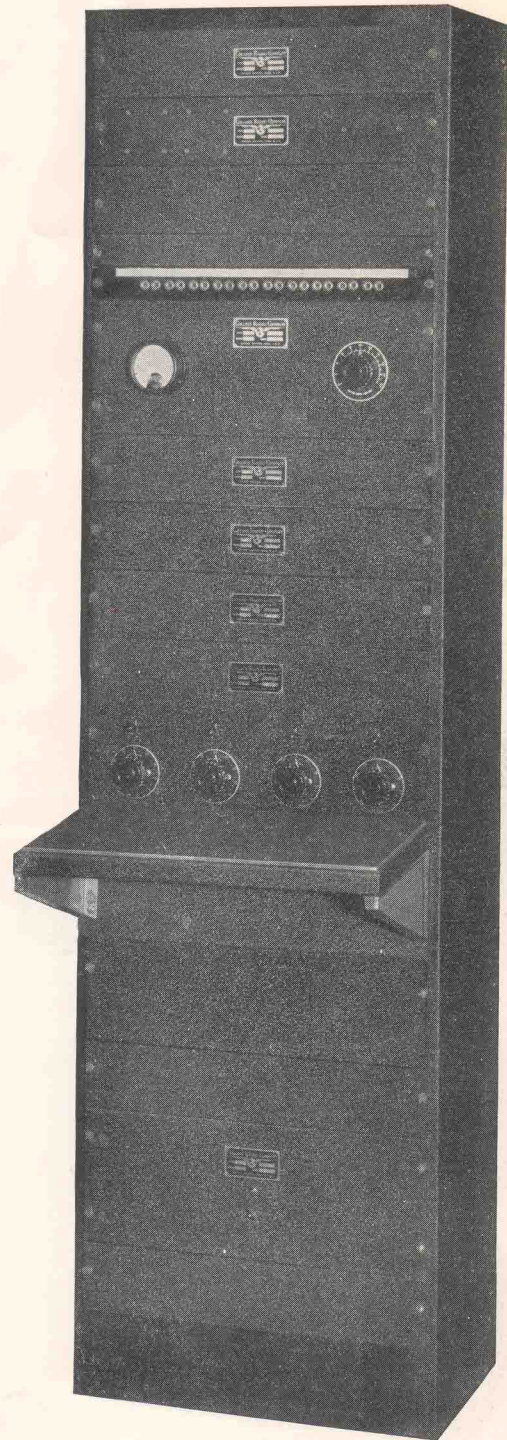

TYPE 12B



COLLINS SERIES 12 S

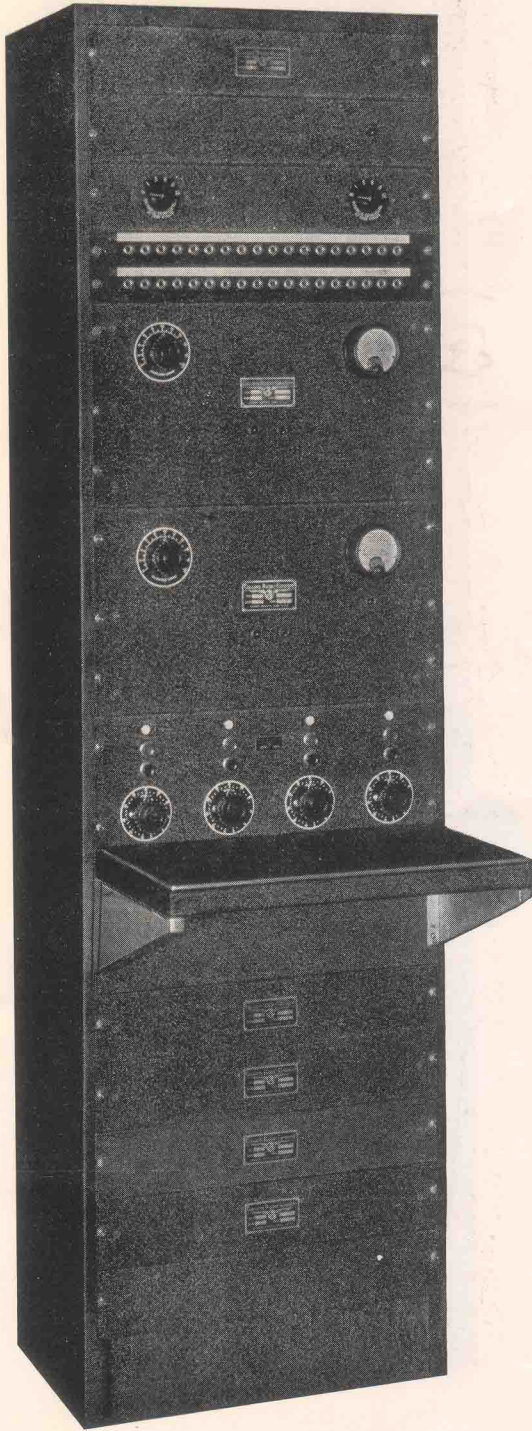

FRONT VIEW

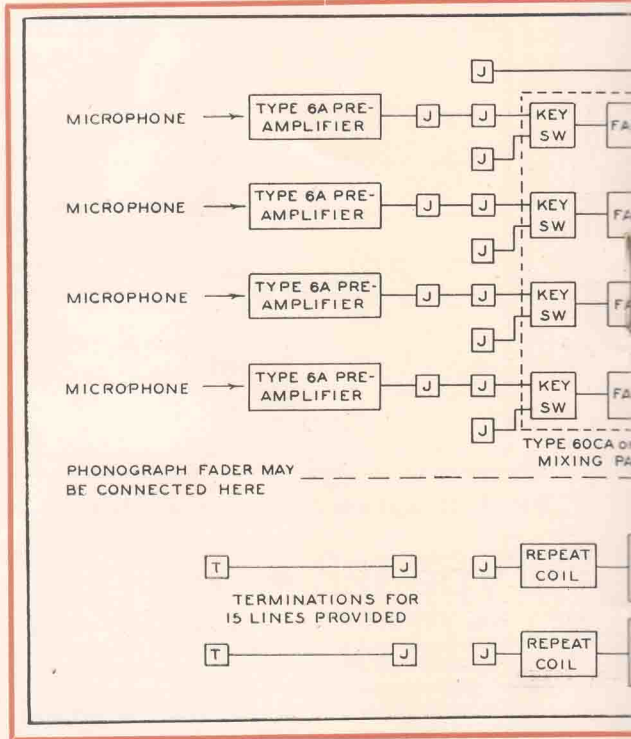

BLOCK DIAGRAM SHOWING

» TYPE

The TYPE 12C Speech Rack includes the facilities for controlling four low level microphones and fifteen remote lines. The TYPE 6A Pre-amplifiers can be furnished either with jack input for crystal microphones or with shielded transformer input for low impedance microphones. Mixing is done at a relatively high level by means of either the TYPE 60BA or the TYPE 60CA mixing panels. The attenuators in both cases are of the noiseless ladder type with an attenuation of 1 decibel per step. In the TYPE 60BA, key switches are provided to instantly cut each channel in or out without rotating the fader. The switches are arranged so that each channel is terminated in a resistor of the proper impedance when in the off position. Standard impedance is 500 ohms per channel. The mixing circuit and equipment of the TYPE 60CA is identical to that of the TYPE 60BA described above. However, instead of using key switches to control each channel, relays are used with push button control at the speech rack and at as many remote points as may be desired. The control circuits are arranged so that a momentary contact on the proper push button serves to open or close the

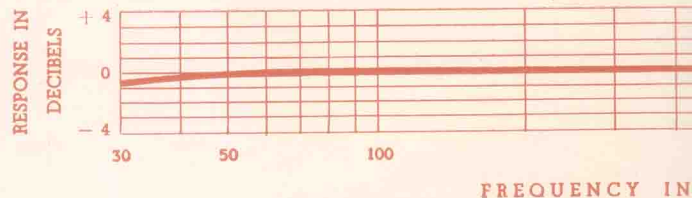

TYPICAL FREQUENCY CHARACTERISTIC CURV

SPEECH EQUIPMENT

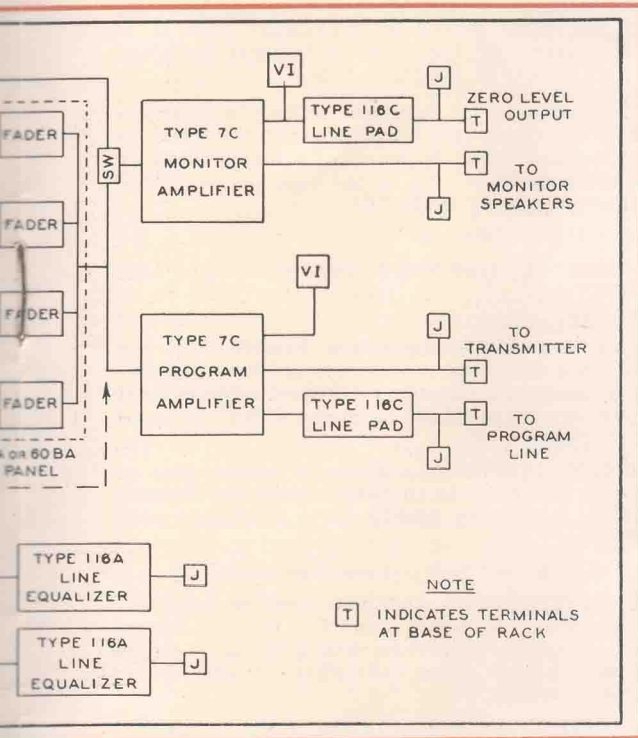

FIG. 12C A TYPICAL 12C ASSEMBLY

TYPE 12C «

channel. Pilot lights are provided at all control points to indicate which channels are in operation. Provisions are made for connecting control circuits for monitor speakers, studio speakers and warning lights. All external connections are made to a shielded terminal strip at the base of the rack. The TYPE 12C is suited for feeding a program line or for driving a transmitter at levels up to plus 32 decibels without auxiliary equipment.

The TYPE 12C Speech Rack includes the following units:

- 2—TYPE 7C Amplifiers with terminal inputs and volume indicators
 - 4—TYPE 6A Pre-amplifiers with jack inputs and 500 ohm outputs
 - 1—TYPE 60BA or 60CA Four-position Mixer Panel
 - 2—TYPE 116A Line Equalizers
 - 2—TYPE 116C Line Pads (20 db.)
 - 2—TYPE 225B Repeat Coils
 - 2—TYPE 265A Jack Strips
 - 4—TYPE 211A Patch Cords
 - 1—TYPE 151B Terminal Strip with Cover
 - 1—110 V. fuse block
- completely assembled with shielded cable and mounted in a TYPE 19A black crinkled rack cabinet with door and arm rest.

TYPE 12C Speech Rack, code word: YAPUL

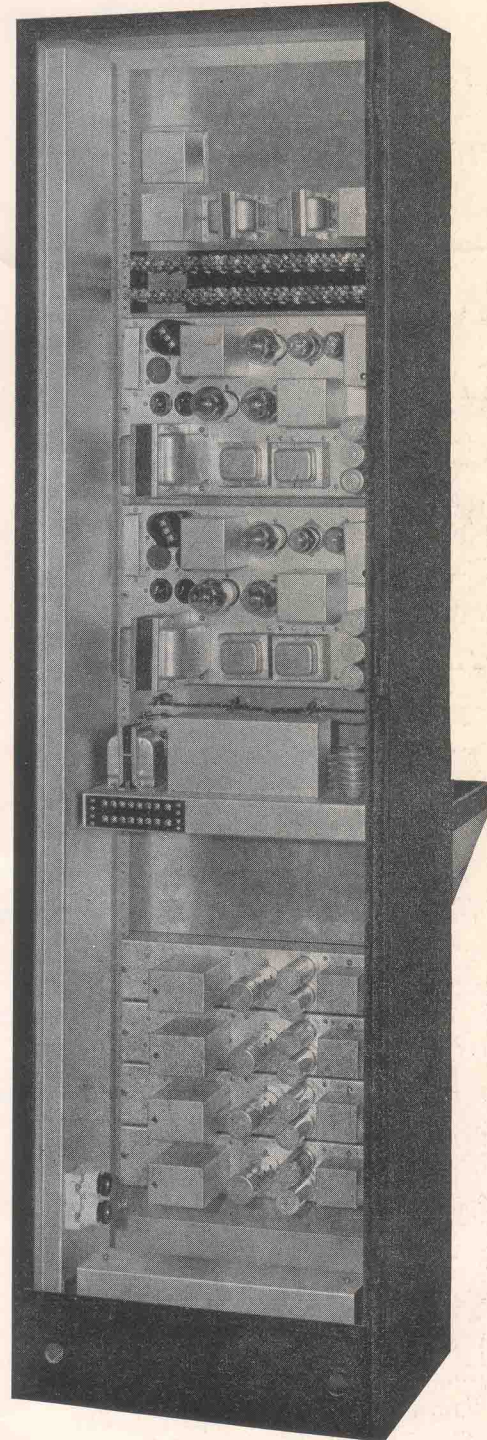

REAR VIEW
(door removed)



RESPONSE OF COLLINS' SERIES 12 SPEECH EQUIPMENT

COLLINS TYPE 7C AMPLIFIER

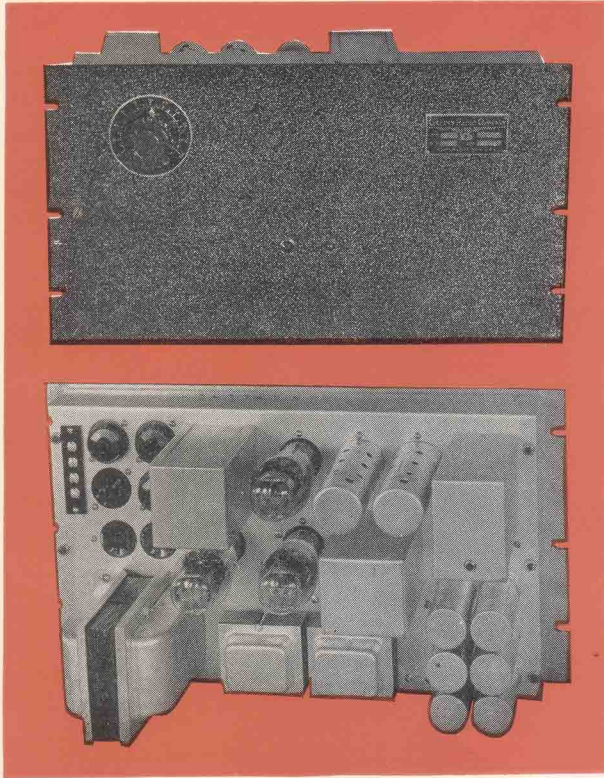

The TYPE 7C Amplifier is a high gain, high fidelity, general purpose amplifier. It is designed for direct operation from a sound-cell crystal microphone, or as a main amplifier following mixing apparatus. The output may be used to drive the modulator tubes of a radio transmitter, a program line, a loudspeaker, or for any other purpose where a source of wide range audio power is required.

The TYPE 7C Amplifier is very easy to put into service, since all connections are made by means of standard receptacles, and the carefully filtered power supply is self-contained.

INPUT: The TYPE 7C Amplifier has an input arrangement which permits it to be used with input circuits of any impedance without the use of input or matching transformers except in the case of a balanced telephone line. The input circuit is connected directly to the grid of the first tube through a resistance network. The only effect of connecting the TYPE 7C Amplifier to circuits of widely varying impedance is that the gain is slightly reduced in the case of low input impedances. An indication of the relation between available gain and input impedance is given by the following table:

GAIN of TYPE 7C Amplifier vs. Input Circuit Impedance	
Input Circuit Impedance	Available Gain
100,000 ohms	110 db
10,000 ohms	100 db
1,000 ohms	90 db
500 ohms	87 db
200 ohms	83 db

HUM: Hum in the TYPE 7C Amplifier has been reduced to the point where at maximum gain it is masked completely by the noise of thermal agitation and "Schrott effect" in the input tube.

The residual noise at full gain setting is chiefly a function of the input resistance, so that the ratio of signal to residual noise is practically independent of input circuit impedance, and in the case of the TYPE 7C Amplifier is entirely negligible.

NUMBER OF STAGES: 4.

TUBES USED: 1—type 6C6, 2—type 76, 2—type 2A3, 1—type 5Z3.

GAIN: 83 to 110 db.

The gain is ample for operation directly from one sound cell crystal microphone without the use of a pre-amplifier although preamplifiers are used when several microphones are to be mixed as in the TYPE 12A and TYPE 12C speech racks.

FREQUENCY RESPONSE: Uniform within plus or minus one decibel from 30 to 10,000 cycles per second. An individual laboratory fidelity curve is shipped with each amplifier.

HARMONIC DISTORTION: Less than 2%.

OUTPUT IMPEDANCE: 500/2000 ohms to duplicate output receptacles (Numbers 1 and 2). A third output receptacle (Number 3) provides 4000/6000 ohms direct from the output tubes (type 2A3) plate circuits. Other impedances to order.

POWER OUTPUT: Class A rating, 7 watts. Maximum undistorted output, 11 watts. The output can be reduced by means of the TYPE 116C Line Pad to plus 10 db. for feeding program lines.

GAIN CONTROL: Special logarithmic noiseless control.

VOLUME INDICATOR (optional): Copper oxide rectifier type meter, calibrated in decibels from minus 10 to plus 6 with switch for two ranges, plus 10 to plus 26 db., and plus 20 to plus 36 db., above zero level (6 milliwatts).

RESIDUAL NOISE LEVEL: 65 decibels below program level.

MOUNTING: 10½" x 19" standard rack panel.

POWER SUPPLY: 110 volt, 60 cycles a. c. 25 cycle models can be supplied on special order.

EXTERNAL POWER CONNECTIONS: 110 volt service cord furnished. Terminal strip for supplying 6.3 v. 2.5 amp. a. c. and 350 v. 30 ma. d. c. to four TYPE 6A preamplifiers.

TYPE 7CH EXTENDED RANGE AMPLIFIER

The specifications for this model are the same as for the TYPE 7C, except as given below:

FREQUENCY RESPONSE: Flat within plus or minus one decibel from 20 to 20,000 cycles per second.

HARMONIC DISTORTION: Less than 2%.

	Code Word
TYPE 7C Amplifier with microphone jack input	YASNO
TYPE 7C Amplifier with terminal strip input	YASAK
TYPE 7CH Amplifier with terminal strip input and extended frequency range	YARPY

COLLINS TYPE 6A - PRE - AMPLIFIER

The TYPE 6A is a two stage amplifier, designed for use with low level microphones, including those of the crystal type. Its excellent frequency response and low residual noise as well as its small size make it very desirable for all broadcast applications.

SPECIFICATIONS

- NUMBER OF STAGES: 2.
- TUBES USED: 1-type 6C6, 1-type 76; or 1-type 57, 1-type 56.
- GAIN: Approximately 60 decibels.
- GAIN CONTROL: None.
- FREQUENCY RESPONSE: Uniform within plus or minus one decibel from 30 to 10,000 cycles per second. Individual fidelity curve furnished with each amplifier.
- HARMONIC DISTORTION: Less than 1/2 of 1%.
- OUTPUT IMPEDANCE: 200 or 500 ohms as specified.
- INPUT IMPEDANCE: Jack or terminal strip to grid of tube. May also be supplied with shielded input transformer for 50/200/500 ohms.
- MOUNTING: 3 1/2" x 19" standard rack panel.
- EXTERNAL CONNECTIONS: Six prong receptacle.
- POWER SUPPLY REQUIRED: 250 to 400 volts d. c. 2.5 or 6.3 volts a. c. or d. c., depending on tubes used.

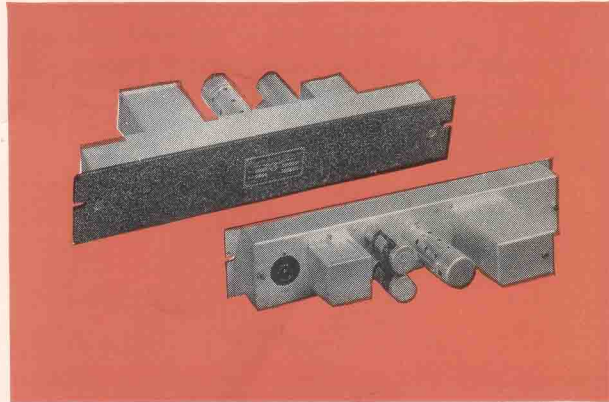

- | | |
|--|-----------|
| | Code Word |
| TYPE 6A PREAMPLIFIER with microphone jack input | YAACS |
| TYPE 6A PREAMPLIFIER with terminal strip input | YAAWN |
| TYPE 6A PREAMPLIFIER with shielded 50/200/500 ohm input transformer..... | YAASK |

COLLINS SERIES 60 MIXING PANELS



TYPE 60B - 60BA

The TYPE 60B and 60BA Mixing Panels embody four constant impedance attenuators and four key switches mounted on a 7" relay rack panel. The attenuators are of the noiseless ladder type with an attenuation of 1 db. per step. Key switches are provided to instantly cut each channel in or out without rotating the fader. The switches are arranged so that each channel is terminated in a resistor of the proper impedance when in the off position. Standard impedance is 500 ohms per channel.

- | | |
|---|-----------|
| | Code Word |
| TYPE 60B Four Channel Fader for use with TYPE 7B Amplifier | YASUP |
| TYPE 60BA Four Channel Fader for use with TYPE 7C Amplifier | YAUCY |

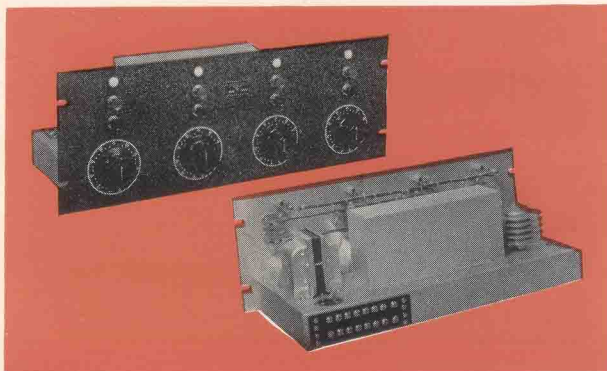

TYPE 60C - 60CA

The mixing circuit and equipment of the TYPE 60C and 60CA are identical to that of the TYPE 60B-60BA described above. However, instead of using key switches to control each channel, relays are used, with push button control at the speech rack and at as many remote points as may be desired. The control circuits are arranged so that a momentary contact on the proper push button serves to open or close the channel. Pilot lights are provided at all control points to indicate which channels are in operation. The power supply for operating the relays is incorporated in the chassis. Provisions are made for connecting control circuits for monitor speakers, studio speakers, and warning lights.

The apparatus is chassis mounted on a standard 7" x 19" rack panel.

- | | |
|---|-----------|
| | Code Word |
| TYPE 60C Four Channel Fader for use with TYPE 7B Amplifier | YATEM |
| TYPE 60CA Four Channel Fader for use with TYPE 7C Amplifier | YAURN |

TYPE 60D MIXING PANEL

The TYPE 60D Mixing Panel is similar to the TYPE 60BA except that a split fader is provided for fading the outputs of two crystal pickups and their associated TYPE 116B equalizers into the program channel.

The TYPE 60D is furnished with three noiseless ladder type attenuators and one phono-fader, allowing the use of six separate 500 ohm inputs and two phono-graph pickups. The output is connected through a resistance network to the grid of a TYPE 7C Amplifier.

TYPE 60D Mixing Panel..... Code Word
YATLA

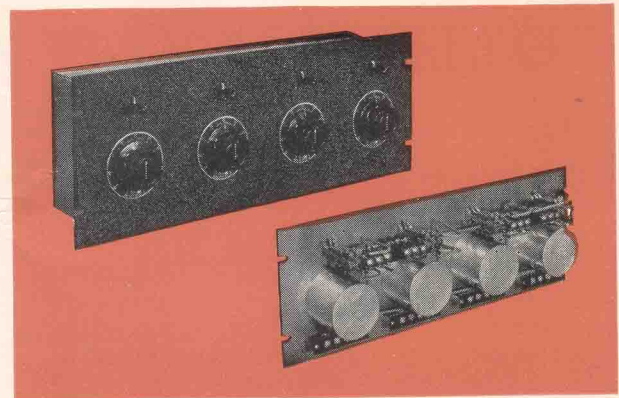

TYPE 116A LINE EQUALIZER

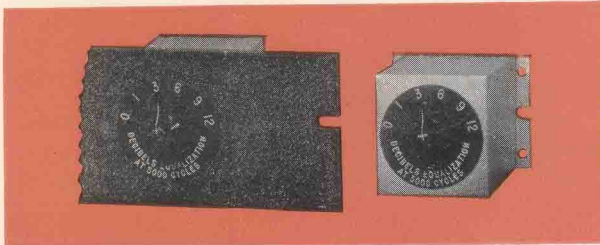

The TYPE 116A Line Equalizer is designed to equalize the high frequency attenuation in telephone lines when used for program lines. Following modern trends, equalization is provided up to 7500 cycles, and the maximum equalization is 15 decibels at that frequency. The equalization is variable in small steps.

The use of an audio frequency oscillator and level indicator is necessary to make best use of the equalizer, but if the frequency response of the line is known, a calibration curve can be supplied which will allow an approximate setting to be made.

The unit is designed for use on 500 ohm lines. Code Word
TYPE 116A Line Equalizer for 500 Ohm lines.....YAWNA

TYPE 116B CRYSTAL PICKUP EQUALIZER

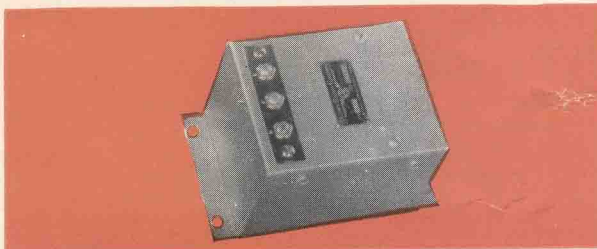

The TYPE 116B equalizer has been developed for use with the TYPE CS-8 or TYPE CS-12 crystal pickup to provide equalization for the characteristics of both the record and the pickup, giving uniform response over a band of frequencies from 50 to 4000 cycles per second, with a sharp cut-off above 4000. It is impractical to attempt to pass a wider band with present day records.

In addition to providing uniform frequency response, the equalizer allows the pickup, which normally appears as a capacity, to be faded and mixed by means of resistances.

Code Word
TYPE 116B Equalizer for Crystal Pickups.....YAWOR

TYPE 116C LINE PAD

When the TYPE 7C Amplifier is used to feed a program line, it is desirable to insert a line pad between the amplifier output and the line. This serves the dual purpose of giving some attenuation and providing the proper impedance match.

The standard model provides approximately 20 db. loss, and matches the TYPE 7C output to a 500 ohm balanced line. Line pads for other impedances can be supplied on special order.

The pad is built in a small bakelite case, and is designed to plug in one of the output sockets of the TYPE 7C Amplifier. Three terminals are provided for the line connections.

Code Word
TYPE 116C Line Pad.....YAWPE

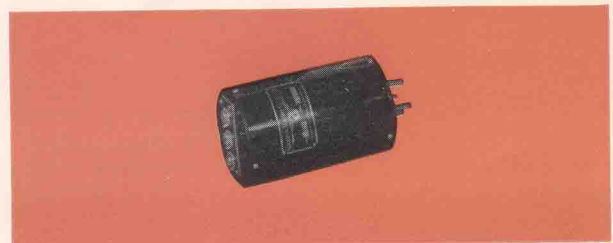

TYPE 265A JACK STRIP AND TYPE 211 PATCH CORD

The TYPE 265A 18 pair jack strip is a considerable improvement both in design and appearance over the twin jacks and plugs commonly used in studios. Three contact plugs and jacks are used, allowing the use of shielded, balanced lines with only a single plug and jack for each line. The strip measures 1 3/4 x 19" and mounts in standard relay rack. It is supplied complete with designation strip. The TYPE 211 patch cord is a two conductor shielded cord 24 inches in length. The plugs are of the three contact shielded type.

Code Word
TYPE 265A 18 Pair Jack Strip.....YAZTO
TYPE 211 Patch Cord.....YEACY

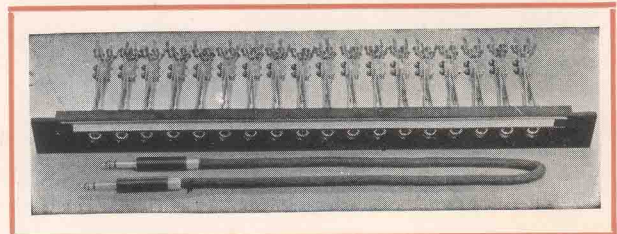

PRICES ON APPLICATION



Series 12

COLLINS INSISTENCE ON CAREFUL, STRAIGHTFORWARD DESIGN, RIGIDLY SELECTED MATERIALS AND SKILLFUL WORKMANSHIP, ESPECIALLY QUALIFIES THE **SERIES 12 SPEECH EQUIPMENT** FOR MODERN BROADCAST SERVICE WHERE HIGH-FIDELITY AND RELIABILITY ARE PARAMOUNT REQUIREMENTS.

PRICES ON THE **SERIES 12 SPEECH EQUIPMENT** WILL BE GLADLY FURNISHED. ADDRESS ALL INQUIRIES TO:

**COLLINS RADIO COMPANY
CEDAR RAPIDS, IOWA, U. S. A.**

