

© RCA Victor
1955



BROADCAST EQUIPMENT

INDEX

	PAGE		PAGE
Microphones	5-16	Standard Line	74-77
Microphone Accessories	15	Construction Permit Data	77-78
Microphone Tabulation	16	Transmitter Accessories	79-81
Speech Input Equipment	17-60	Facsimile Equipment	82
Custom Built Installations	20-22	Television Equipment	83-86
Factory Assembled Equipment	23-29	Measuring Equipment	87-106
DeLuxe Line Units	30-37	RCA V-Cut Crystals	107-120
Standard Line Units	38-40	Faradon Condensers	121-128
Economy Line Units	41-47	RCA Transmitting Radiotrons	129-133
Summary of RCA Broadcast Amplifier Characteristics	48	RCA Receiving Type Tubes	134-136
Speech Input Accessories	49-52	Other RCA Products	137-144
Loudspeakers	53	Aviation Radio Equipment	138
Transcription Turntables and Accessories	54-57	Police Radio Systems	139
Field Amplifier Equipment	58-59	Commercial Sound Equipment	140
How to Order Equipment	60	Photophone Equipment	141
Transmitters	61-86	Communications Equipment	142-143
De Luxe Line	66-73	Data Section	145-150

INDEX BY TYPE NUMBERS

TYPE	EQUIPMENT	PAGE	TYPE	EQUIPMENT	PAGE	TYPE	EQUIPMENT	PAGE
1-E	Transmitter	67	90-B	Boom Stand	15	MI-4437	Cabinet	53
1-G	Transmitter	76	91-A	Stand	15	MI-4438	Cabinet	53
5-D	Transmitter	68	91-B	Stand	15	MI-4589-99	Blank Panels	40
5-DX	Transmitter	70	93-A	Vibrator Power Unit	93	MI-4650-2, 4, 6	Patchcord	49
9-A, B, C,	Racks	50	92-A	Lighting Choke	79	MI-4855	Booster	59
10-D	Transmitter	69	94-D	Amplifier	35	MI-4857	Tonearm	56
13-D	Volume Indicator	97	96-A	Limiter	36	MI-4861	Tonearm Lift	56
15-B	Meter Panel	39	100G	Transmitter	75	MI-4878	Sapphire Styli	56
15-C	Meter Panel	37	105	Antenna Tuner	80	MI-4879	Steel Styli	56
30-A	Microphone	14	250-D	Transmitter	66	MI-4887	Recording Head	57
33-A, B	Jack Panels	49	250-G	Transmitter	75	MI-4888	Float Stabilizer	57
35-A, B, C	Shelves	50	300-A	Phase Meter	99	MI-4898	Compensator	55
36-A, B	Panel and Shelf	47	301-A	U.H.F. Field Meter	100	MI-6226-A	Microphone	13
40-C	Amplifier	40	302-A	Audio Meter	92	MI-7113-A	Volt Control	70
40-D	Amplifier	33	303-A	Frequency-limit Monitor	98	MI-7127	Power Panel	73
41-B	Preamplifier	39	304-A	Oscillograph	89	MI-7237	Control Console	81
41-C	Preamplifier	32	305-A	Oscillograph	101	MI-11300	Power Supply	36
44-BX	Microphone	8	307-A	Pressure Conversion Unit	104	MI-11302	Power Supply	44
46-B	Mixer Panel	37	310-A	Plate Supply	93	MI-11500	Cabinet	29
50-D	Transmitter	72	314-A	Pressure Indicating	104	MI-11600	Cover OP-5	51
54-A	Power	52	350-A	Square Wave Generator	102	MI-11606	Fil. Transformer	44
55-B	Amplifier	34	351-A	Oscillator	102	MI-11700	Plate Current Meter	47
56-B, C, E, D	Equalizers	51	352-A	Sweep	103	MI-11701	Meter Transfer Switch	47
57-A	Switch Panel	49	353-A	Sweep Rectifier	103	OP-5	Field Amplifier	58
57-A	Field Power Supply	53	560-A	Synchronizing Generator	103	P3-35	Receptacle	14
58-A	Triamplifier	36	561-A	Auxiliary Rack	103	P3-CG-11	Connector	14
59-A	Stand	15	580-A	Plate Supply	94	P3-CG-12	Plug	14
62-A	Field Amplifier	59	582-A	Filter Panel	94	PB-112-B1	Handset	14
64-AX	Speaker	53	AC-95	Crystal	116	T-1	Television Transmitter	85
66-A	Modulation Monitor	98	ACT-20	Transmitter	142	TMV-129-B, C	Crystal	117
68-B	Oscillator	95	ACT-150	Transmitter	143	TMV-135	Crystal	118
69-A	Distortion Meter	96	AP-4234	Adaptor	15	UZ-4209	Speaker	53
70-C	Turntable	54	AR-4291	Transceiver	143	UZ-4309	Speaker	53
71-B	Tonearm	55	AR-60	Receiver	142	XT-2769	Transformer	52
72-B	Recorder	55	AR-67	Receiver	143	XT-2770	Transformer	52
74-B	Microphone	9	AVA-10	Crystal	113	XT-2771	Transformer	52
75-B	Field Meter	100	AVA-11	Crystal	114	XT-2830	Transformer	52
76-B	Console	28	AVA-37	Crystal	115	XT-2831	Transformer	52
77-B	Microphone	10	AL-4293	Antenna Coupler	79	151†	Oscillograph	91
77-C	Microphone	11	ET-4315	Transmitter	77	151-2	Oscillograph	91
78-B1	Speech Input	24	FAX-1, 2-A, 2-C	Facsimile	82	155	Oscillograph	91
78-C1	Speech Input	25	*MI-1500	Filament Supply	94	158	Oscillograph	90
80-A	Control Desk	26	MI-1520	Filament Supply	94	160	Oscillograph	90
80-B	Control Desk	27	MI-3526	Plate Supply	94	9641	Oscillograph	90
81-A	Mixing Console	29	MI-3527	Plate Supply	94	9765	Vibration Pickup Unit	105
81-B	Mixing Console	29	MI-3528	Plate Supply	94	9784	Amplifier	105
82-B	Amplifier	46	MI-4015	Microphone	13	9785	Vibrator Power Supply	93
84-A	Amplifier	45	MI-4065-A	Stand	15	9786	Synchronizer	105
85-A	Preamplifier	42	MI-4068-A	Stand	15	9787	Calibrator	106
85-X	Isolation Amplifier	43	MI-4082-A	Shock Mtg.	9	9796	Transformer	105
88-A	Microphone	12	MI-4303	Power Supply	44	9819	D-C Meter	92
89-A	Atten. Panel	97	MI-4308	Power Supply	52	15889	Record Weight	56
90-A	Stand	15	MI-4315	Comp. Network	41	32200	Speaker	53

*MI--numbers are used for all equipment. They have been listed here only where no type number has been assigned.

† Stock numbers.

RCA

BROADCAST STATION

EQUIPMENT

*

JULY • 1939

Price . . . Fifty Cents

Transmitter Section

RCA MANUFACTURING COMPANY, INC.

A Service of Radio Corporation of America

Camden, N. J.

With Branches, Factories or Subsidiaries Located in:

Harrison, N. J.	Montreal, Canada	Rio de Janeiro, Brazil
Indianapolis, Ind.	Mexico City, Mexico	Shanghai, China
Hollywood, Calif.	Buenos Aires, Arg.	London, England

Transmitter Sales Offices at:

1270 Sixth Avenue New York City	589 E. Illinois Street Chicago, Ill.	530 Citizens' and Southern Bank Bldg. Atlanta, Ga.
Santa Fe Bldg. Dallas, Texas	1016 N. Sycamore St. Hollywood, Calif.	170 Ninth Street San Francisco, Calif.

INTRODUCTION

•

IN PRESENTING the second edition of the Broadcast Equipment Catalog, we have endeavored to broaden its scope in order that it may prove more valuable to the engineer. Individual units are discussed more fully, additional sections have been included and new equipment is shown. It does not represent by any means a complete list of apparatus which can be supplied by RCA Manufacturing Company. For example, RCA Public Address and Centralized Radio equipment is shown in a separate catalog as is Photophone recording and reproducing equipment. Descriptive material on RCA Victor radio receivers (which will undoubtedly be of interest to broadcasters) can be obtained from any RCA representative, dealer or distributor. However, certain of the items included in these other lines have been described herein since they may be useful to stations for various purposes. Among these items are loudspeakers and mountings, communications receivers and transmitters.

The information presented on broadcast equipment is intended to be sufficiently comprehensive to give a clear picture of each piece of apparatus. However, individual bulletins are available for each major unit and may be obtained upon request. Attention is also directed to the comparative tables at the end of each section where differences and similarities of apparatus are clearly set forth and the conditions of use outlined. If there is any doubt as to type of equipment required, it is recommended that the reader first consult the proper table and then the individual unit, rather than vice versa. For example, the table of microphones on page 16 will enable the purchaser to obtain the type best suited to the needs of the station. After this, the individual description will provide full data.

H. I. Neher

THIS IS RCA



Above: NBC Studio 8-H, Largest Broadcasting Studio in the World



Left: View of the RCA Building, New York



A Class at RCA Institutes.

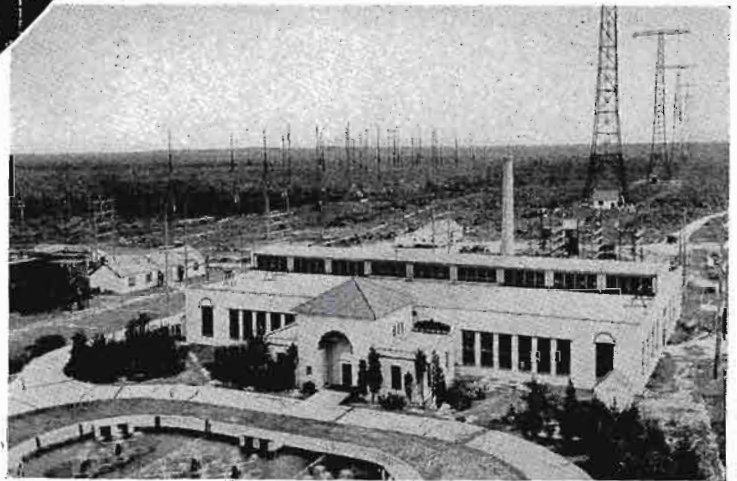

Above: Radio central—the RCA Communications station at Rocky Point, L. I.

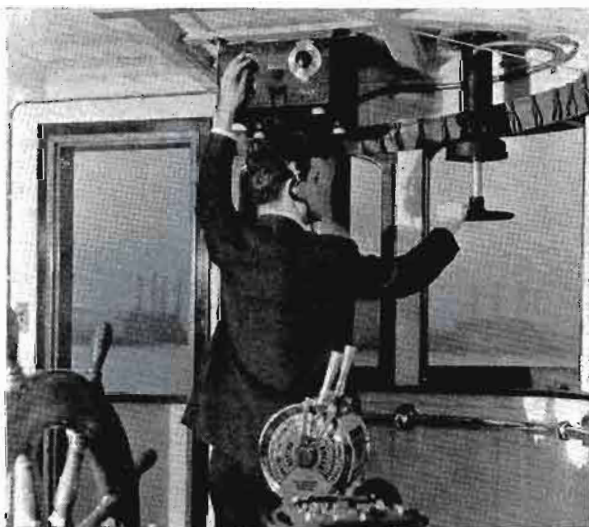

Radio-Marine Installations are Found Throughout the World.



Above: RCA Manufacturing Co., Inc., Camden, N. J. Devoted Exclusively to Manufacturing Everything in Radio from the Microphone in the Studio to the Receiver in the Home.

FOREWORD

The activities of RCA embrace every field of the radio art and its services reach almost every country of the globe. Its operations in these many fields are carried on by its five subsidiary companies, each of which confines its activities to one of the well defined major divisions of the radio industry. Thus, RCA Communications, Inc., which is strictly an operating company, maintains and operates a world-wide system of international communications, as well as domestic radio circuits between the large centers of population. In addition, it provides the international program service which has made possible the successful rebroadcasting in this country of foreign programs and vice versa. In this field its direct communication circuits and its extensive diversity-type receiver installations have made it indispensable.

The Radiomarine Corporation of America, as its name implies, carries on RCA activities in the field of marine radio. In this field of radio communication, particularly important because radio is the only possible means of communication with ships at sea, the Radiomarine Corporation is one of the world's leading companies.

The National Broadcasting Company is the RCA operating company in the entertainment field. It operates two nationwide station networks and furnishes programs to a large number of stations linked together by specially engineered telephone lines and radio circuits. Of these stations NBC itself owns and operates some of the largest, while the remainder are furnished programs on a contract basis. In addition to its Radio City studios, the world's largest broadcasting plant, NBC maintains and operates extensive layouts in Chicago and Hollywood, and smaller studio installations in other station cities. It offers a complete broadcast advertising and program building service and provides radio talent of all kinds including the NBC Thesaurus transcription service.

The RCA Institutes, Inc., is a company devoted to the teaching and training of radio engineers and operators. It offers practical instruction in radio and its associated electronic arts. At its two residence

schools in New York and Chicago, it offers an extensive list of courses in every field of radio engineering and operating. In addition, it offers correspondence courses in servicing and operating radio and sound systems.

The four previously mentioned companies are all more or less operating companies. The fifth company of the RCA family—the RCA Manufacturing Company—differs in that it is devoted entirely to the development and production of radio equipment. While it furnishes the equipment used by the four RCA operating companies, this constitutes only a very small percentage of its total business. By far the greater part of its facilities are devoted to the production of equipment for sale to other users. This includes not only receivers, phonograph combinations and the like for home use, but also many types of specialized equipment for other radio and allied applications. In the development, design and test of such equipment the RCA Manufacturing Company has the benefit of the cooperation of the other RCA companies and its engineers are, therefore, in a position to take advantage of the latest and most advanced engineering knowledge. The broadcast transmitting and speech input equipment offered by the RCA Manufacturing Company is an outstanding example of this coordinated RCA development.

The extent of the far-flung RCA Services, the unequalled experience of RCA engineers and the manufacturing and laboratory facilities of the RCA Manufacturing Company have been described here in detail because of the part they have played in the development and production of the broadcast transmitters and speech input equipment which are described in the following pages. It is with pride and confidence that the RCA Manufacturing Company offers to broadcast stations this line of transmitting and speech input equipment—pride, that it is by far the finest equipment yet developed for the purpose—confidence, that it will insure continuance of the high regard with which broadcast engineers have come to hold RCA broadcast equipment.



MICROPHONES

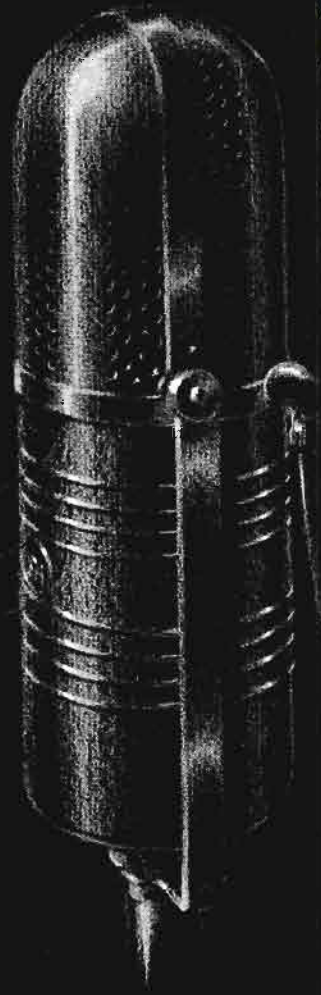

MICROPHONES

BROADCAST microphones are used under widely differing conditions. No single design or type of microphone has yet been developed which is completely suited for operation under all of these conditions; hence, for broadcasting, there is no such thing as an all-purpose microphone. For this reason, the RCA Manufacturing Company makes available several different types of microphones, each having characteristics of particular advantage for certain kinds of use.

THE VELOCITY MICROPHONE is more highly perfected and has a broader and more uniform response than any microphone yet produced. It is primarily intended for use in high quality studio production and, when so used, is capable of transmission fidelity unapproached by any other type of microphone.

THE JUNIOR VELOCITY MICROPHONE is a small-sized model of the high quality studio-type microphone. Inexpensive, rugged and convenient, it is particularly suited for remote pickups from interior points and for occasional studio use.

THE UNI-DIRECTIONAL MICROPHONE is an RCA-developed microphone which has the unique characteristic of presenting high attenuation to all sounds arriving from the rear direction. This negligible back pickup makes it of unequalled advantage for auditoriums and similar pickups where audience noise must be suppressed. It is also of advantage in reducing excess reverberation pickup and, in small studios, in arranging placement of artists.

THE THREE-WAY MICROPHONE is a new development designed to give station owners the advantage of three microphones in one. A twist of the switch makes it uni-directional, bi-directional or non-directional.

THE PRESSURE MICROPHONE is designed especially for outside pickup use. Because it has a relatively high output, is smaller, lighter and less affected by wind, it is better suited for most outside work.

THE TALK-BACK MICROPHONE utilizes a sound-powered unit to obtain very high output levels with good intelligibility.

THE AERODYNAMIC MICROPHONE is an inexpensive microphone of the pressure-operated type. Of convenient dimensions and attractive appearance this unit finds a handy application as a "talk-back" microphone and for emergency announce purposes.

VELOCITY MICROPHONE

Type 44-BX . . . *The Standard Microphone of Broadcasting*

THE TYPE 44-BX Velocity Microphone was developed by RCA engineers to meet a long standing need for a microphone capable of reproduction fidelity equal to that of the other equipment of a modern broadcast station. It is not to be compared with other types of microphones for it is totally different, both in construction and in operation; and, because of its unique features, so far excels in reproduction quality as to be properly placed in a class by itself.

The Type 44-BX Velocity Microphone, unlike other types of microphones, has no diaphragm—the moving element being, instead, a thin metallic ribbon so suspended as to be able to vibrate freely between the poles of a permanent magnet. Because of its lightness, the motion of this ribbon corresponds exactly to the velocity of the air particles and the voltage generated in it is, therefore, an exact reproduction of the sound waves which traverse it. Moreover, since it has no diaphragm and is open in construction so that air flows freely through it, the Type 44-BX Velocity Microphone is free from the effects of cavity resonance, diaphragm resonance and pressure doubling, which cause undesirable peaks in the response of all pressure type microphones. As a result it provides reproduction of unequalled uniformity and smoothness over the whole audio range.

Advantages of the Type 44-BX Velocity Microphone are not limited to superb reproduction fidelity for the special



characteristics represent an almost equally attractive feature. The directional pattern is of the "figure eight" type, giving the microphone a bi-directional characteristic. This is a feature of considerable convenience as it provides a pickup configuration corresponding closely to average studio dimensions. Not only does it allow placing of artists on both sides of the microphone but it also, because of the dead sides, greatly reduces reflection from side walls.

While the Type 44-BX Velocity Microphone is very sensitive, it is extremely rugged and, in general, better suited to stand hard usage than are most other microphones. Moreover, because it is constructed almost entirely of metal and because of the low impedance of the ribbon, it is unaffected by temperature, humidity or changes in air pressure. Used either in the studio or in the field, this unit makes an extremely good appearance. The shape is attractive and the new finish—chrome and black—is modern. Matching mountings are available. A shock-proof mounting is furnished.

SPECIFICATIONS

Output Impedances 50/250 ohms
 Output Level —49 VU
 Frequency Response 30-15,000 cycles
 Finish polished black and chromium
 Mounting 1/2" pipe thread
 Dimensions:

Overall length including cushion mounting 12"
 Overall width 4 3/4"
 Overall depth 3 3/8"
 Weight (unpacked, including mtgs.) 8 1/2 lbs.
 Supplied with 30' shielded cable, less plug.

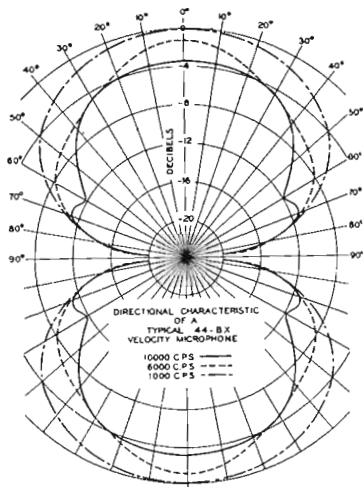
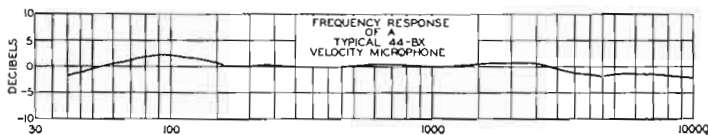

Directional Response Diagram of 44-BX

JUNIOR VELOCITY MICROPHONE

Type 74-B . . . A Small Sized Velocity Type Microphone

THE TYPE 74-B Junior Velocity Microphone is an inexpensive model which has several advantageous applications in broadcast use as well as sufficient flexibility for use in emergency under almost any conditions. It will be found particularly well suited for remote pickups at inside points. In night clubs, restaurants and the like, where lines and other limiting features make the extended response of the deluxe model unnecessary, this inexpensive unit can be used to advantage. Similarly, for banquets and speeches where the directional characteristics of the velocity type microphone are of importance, it may be found better suited than would microphones of non-directional types. It is also a useful microphone for audition studios or for small or occasionally used studios.

In design the Type 74-B Microphone is similar to its bigger brother, the 44-BX Microphone. The frequency response, while not as extended, is in general, smoother than that of other types of microphones and is free from objectionable peaks or dips throughout the range of 70 to 8,000 cycles. The built-in transformer has output connections providing impedances of 50, 250 and 15,000 ohms. The output level is approximately the same as that of the larger size RCA microphones. The 74-B Microphone is somewhat smaller than the deluxe model and is unusually light, weighing only 2½ lbs. For many pickups outside of the studios, particularly for banquets and similar occasions, microphone size is of importance not only because of portability but also because it is undesirable to obstruct the speaker's view with an unnecessarily large microphone. Obviously the Type 74-B Microphone is of advantage in this respect. The appearance also is such as to lend itself to such use. The die-punched, perforated shield is finished in chromium, while the transformer case is black. Attached to the base is a ball and socket joint which makes it possible to rotate the microphone in any direction and to tilt it as desired.

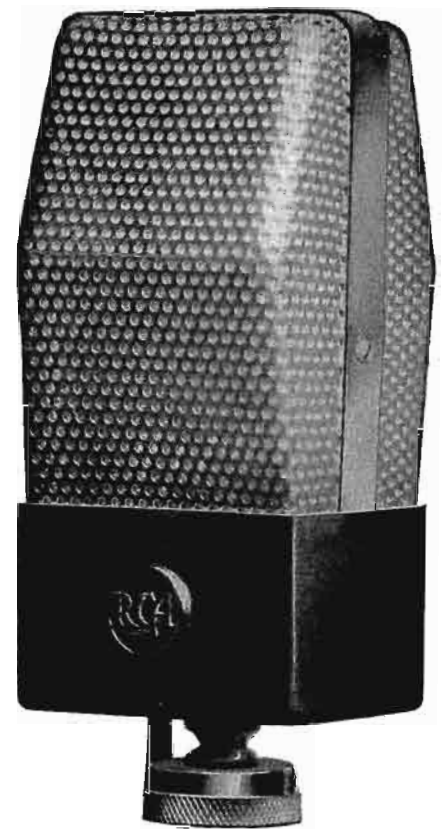

SPECIFICATIONS

- Output Impedance 50/250/15,000 ohms
- Output Level —51 VU
- Frequency Response (See curve)
- Finish Polished Black and Chromium
- Dimensions (overall) 7¾" high, 4" wide and 2½" deep.
- Weight 2½ lbs.

A ball and socket mounting (½" pipe thread) and a 30' shielded rubber covered cable less plug are furnished.

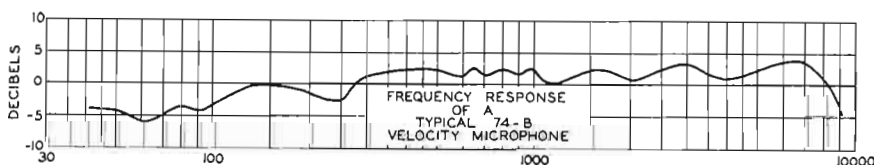

UNI-DIRECTIONAL MICROPHONE

Type 77-B . . . A Special Microphone for Critical Pickups

THE TYPE 77-B Uni-directional microphone can be used to excellent advantage in practically any type of studio installation. For example, in an auditorium studio or in one which provides space for an audience, this Uni-directional microphone can be used to pickup the entire action on the stage because of its cardioid pattern and will suppress, approximately 20 to 1, any undesirable noises originating in the audience. It can also be used to advantage in small studios where the reverberation time tends to be objectionable, precluding the use of a non-directional microphone. In a given studio, the type 77-B microphone can be used with approximately 1.73 times less reverberation pickup than a non-directional microphone. It is ideal for applications where it is necessary to place a microphone close to a wall or a window, since the pickup of reflected sound from the wall or glass is materially reduced.

Its operation is similar to that of the type 77-A Uni-directional microphone which it supersedes, namely; a single ribbon fixed at the center, one-half operating as a velocity microphone and the other half operating as a pressure type. The two outputs of the ribbon are connected in series and the resultant vector addition of the generated voltages produces a directional characteristic as shown below. This curve also shows the uniformity of the directional response with respect to frequency. The microphone's small size, light weight, rugged construction and good sensitivity recommend it as one which no station can afford to lack.

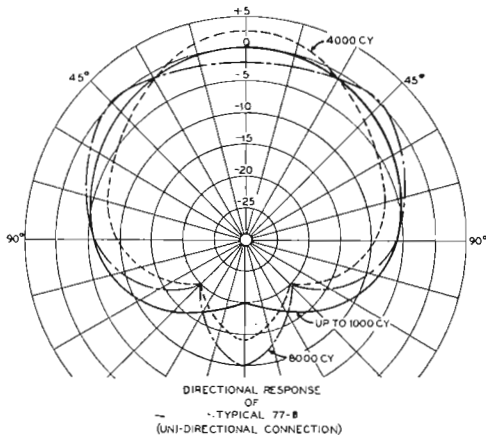

SPECIFICATIONS

Output Impedances.....	50/250 Ohms
Output Level	—55 VU
Frequency Response.....	See curve
Directional Ratio.....	10 to 1 —20 db.
Finish.....	Polished Black and Chromium
Mounting.....	1/2" pipe thread
Dimensions overall length (including mounting) 10"; width 3 3/4"; depth 2 1/2"	
Weight.....	Unpacked including mounting 2 lbs.

Supplied with 30' shielded cable, less plug.

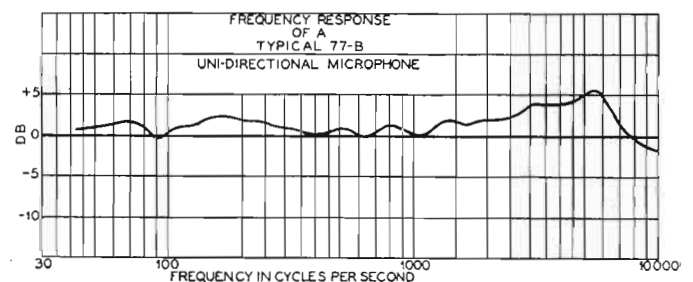

COMBINATION MICROPHONE

Type 77-C

Non-Directional, Bi-Directional or Uni-Directional Response at the Twist of a Switch

THE TYPE 77-C microphone which is slightly more expensive than the type 77-B provides the station owner with the equivalent of three microphones in a single unit. The general construction is similar to that of the 77-B. It can be used in all applications where a uni-directional microphone is desirable and in addition can be operated at the twist of a switch as a bi-directional velocity microphone or as a pressure operated non-directional microphone. Its exceptionally fine frequency characteristics are shown below, together with the directional patterns when used as any one of these three types.



SPECIFICATIONS

Output Impedance (MI-4042-A)250 ohms
(MI-4042-B) 50 ohms
Output Level Uni-directional-55VU
Bi-directional-58VU
Non-directional-58VU
Frequency Response See Curves
Directional Ratio . . . (Uni-directional)	10 to 1 —20 db
Finish Polished black and chromium
Mounting 1/2" pipe thread
Dimensions Overall length—inc. mounting 8 1/2"
Overall width—inc. mounting 3 3/8"
Overall depth—inc. mounting 2 1/4"
Weight 3 lbs.
Supplied with 30' shielded cable, less plug.	

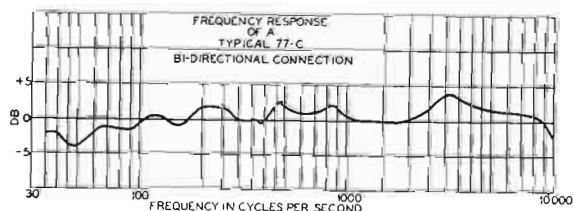
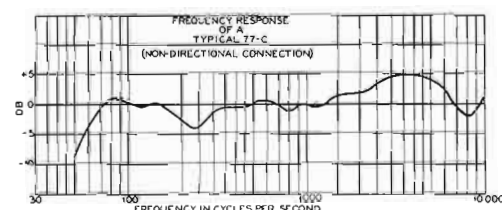
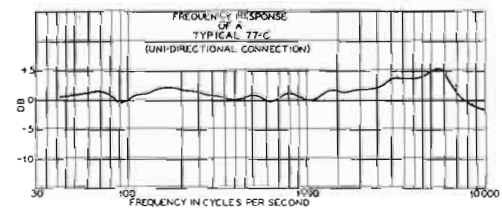
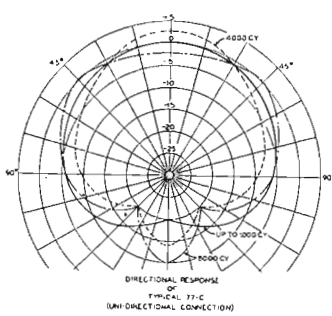
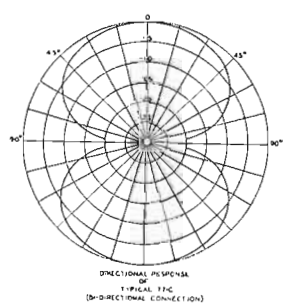
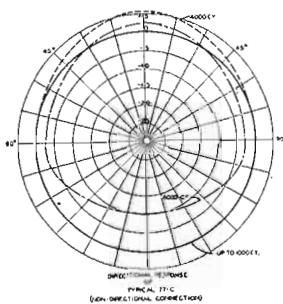

PRESSURE MICROPHONE

Type 88-A

A Rugged Non-Critical Unit Especially Suited for Remote Pickups



The 88-A Microphone is shown mounted on the 91-B Desk Stand.

THE TYPE 88-A Pressure microphone excels in the four requisites of an ideal remote pickup microphone, namely; light weight, high output, good frequency response and freedom from the effects of wind and moisture.

Tipping the scales at but one pound it is truly the remote pickup man's ideal microphone. In spite of its light weight and small size, it is extremely rugged and well-suited to stand the hard usage to which a remote microphone is put. The high output, —46 VU keeps the signal-to-noise ratio in any remote pickup at least 6 db. better than ever available in a microphone of this quality. The frequency response as shown below extends from 60 to 10,000 cycles with remarkably few peaks usually found in a pressure or inductor type microphone. Its diaphragm of molded styrol is practically impervious to moisture and

together with the wind screen supplied with this microphone makes the effects of objectionable currents of air practically unnoticeable. Like all RCA microphones it is styled and finished in a manner which will make you proud to use it under any circumstances.

Not only is the type 88-A pressure microphone ideal for remote pickups, but also because of these very qualities it is excellent for many types of studio use where a non-directional microphone is desirable. Not content with making a microphone of this quality, RCA engineers have designed it to sell at a surprisingly low cost in comparison with any type microphone.

SPECIFICATIONS

Output Impedances.....50/250 ohms
Output Level.....—46 VU
Frequency Response.....See curves
Finish.....Polished black and chromium
Mounting..... $\frac{1}{2}$ " pipe thread
Dimensions.....Overall length $4\frac{1}{2}$ " ; width $2\frac{1}{8}$ " ; depth 4"
Weight1 lb.

MI-4048 supplied with 6' shielded cable, less plug.

MI-4048-A supplied with 30' shielded cable, less plug.

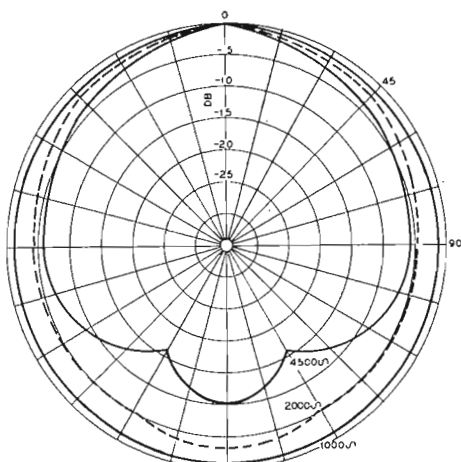

DIRECTIONAL CHARACTERISTICS
OF A
TYPICAL 88-A

*Directional Characteristics When
Mounted Horizontal*

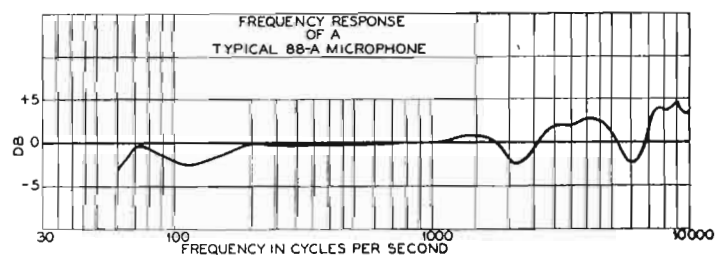

SPECIAL TALKBACK MICROPHONE Type MI-4015

Featuring Unusually High Output Level

MI-4015 Press-to-Talk Microphone

A NEED has long been felt in the broadcast industry for a talk-back microphone with good, intelligible, quality, modern appearance and an output level sufficiently high for it to be fed directly into the monitor amplifier. The MI-4015 press-to-talk microphone incorporates all of these features and several others extremely desirable in this type of equipment, including a press-to-talk switch assembled in the stand. When fed into a 250 ohm load the frequency response of this microphone extends from 200 to 2500 cycles. It is mounted in a case almost identical with that of the aerodynamic microphone, presenting a fine streamlined appearance. The stand, which is approximately 12" high, is likewise modern in appearance and contains a short black bar, which, when pressed, closes a single pole switch. The four-conductor cable normally supplied contains a pair of leads from the output of the microphone and another pair which is the d. c. circuit to the switch.

Its obvious application is to enable the operator to talk back from the control room to the studio. However, another of its many applications is for a program director's microphone. It may be connected across the terminals of the present talk-back key enabling the program director to walk around the control room with this microphone in his hand. This system permits both the operator and the director to talk back into the studio simultaneously or one at a time, each using his own microphone.



The MI-4015 Microphone is supplied with stand.

SPECIFICATIONS

Output Impedance.....	250 ohms
Output Level.....	—39 VU
Frequency Response.....	200-2500 cycles
Finish.....	Polished back and chromium
Mounting.....	Complete with stand
Dimensions.....	Overall height, 12"; Base diameter, 5"
Weight	1½ lbs.

Supplied with 6' of 4 conductor cable, less plug

AERODYNAMIC MICROPHONE Type MI-6226-A

An Inexpensive Pressure Type Microphone for Talkback Use



The Aerodynamic Microphone with the MI-6227 Stand (special for this microphone).

THE TYPE MI-6226-A Aerodynamic Microphone is an inexpensive unit which, while not designed specifically for broadcast use (as are all of the preceding models), nevertheless, has one particular application for broadcast purposes: viz, where a microphone is needed for communication ("talkback") from the booth to the studios.

The Type MI-6226-A Microphone neatly meets the ordinary requirements for talkback purposes. While the frequency response is limited, it is sufficient for pleasing voice transmission—all that is required. In emergency it is good enough for announce use. The output level is comparable to that of broadcast type microphones, facilitating switching. The unit is of convenient dimensions, is housed in a chromium plated, streamlined (tear-drop) case of attractive design and can be furnished with a convenient matching stand. Finally, because of quantity production, it offers the advantages of reliability and comparatively good quality at an unusually low price. Use MI-6227 Stand.

SPECIFICATIONS

Output: 250, 40,000 ohms. Output Level: for a 10-bar input, (250 ohm load) —57VU. Frequency Response: 100 to 6000 cycles, rising. Finish: chromium. Dimensions: 2½" diameter, 3¾" deep. Weight: 1¼ lb. (net). Accessories: 6' cable furnished—stands available. (Type MI-6227 illustrated.)

LAPEL MICROPHONE

Type 30-A . . . A Velocity Type Unit for Especially Difficult Pickup Conditions

THE TYPE 30-A Lapel Microphone has been developed to meet a very particular situation: viz, that where the speaker or artist requires a wider latitude of movement than can be tolerated when the pickup is made with a fixed microphone. This may occur at banquets and similar events, particularly when the speaker is unaccustomed to addressing a fixed microphone, and even in the studio as, for instance, in demonstrations of cooking and the like.

Essentially the Type 30-A Lapel Microphone is a miniature velocity microphone similar in principle of operation to the deluxe Type 44-B microphone. The pickup pattern is such that when it is placed in correct position on the coat lapel the movements of the speaker's head are normally such that his mouth traces a path on a sphere of equal sensitivity and the pickup, therefore, remains at an equal volume regardless of head movement.

SOUND POWER TELEPHONE HANDSET Model PB 112-B-1



MICROPHONE PLUGS AND RECEPTACLES

MOST RCA microphones are sold without plugs in order that the purchaser may use any type desired. However, Cannon fittings are recommended for their reliability and freedom from noise. For convenience to broadcasting stations, a number of these fittings are stocked by RCA.

P3-CG-12 Male Plug for microphones (locking).

P3-35 Wall Receptacle for plug (no cover).

P3-CG-11 Female Connector for plug (extensions).

The P3-35 receptacle will fit in a Sprague No. SP-5800 outlet box. Provision is made in plugs and receptacles for three connections.

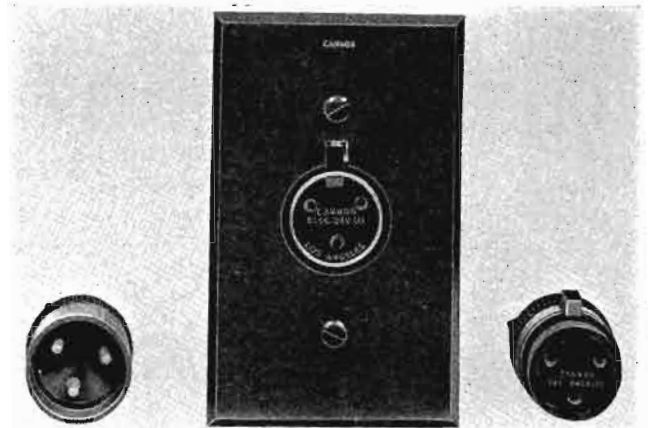

MICROPHONE CABLES

MANY stations have requested microphone cable to be used as extension cords or for replacing old microphone cables and it has been decided to place on sale the special RCA microphone cable now used on almost all standard RCA microphones. This cable consists of two

SPECIFICATIONS

Output Impedance: 250 ohms. Output Level: for a 10-bar input, (250 ohm load) —86 db.* Frequency Response: fair uniformity from 80 to 7000 cycles. Finish: plain black. Dimensions: $1\frac{3}{8}$ " x $1\frac{5}{16}$ " x $1\frac{5}{16}$ ". Weight: $3\frac{1}{4}$ oz. Accessories: a microphone-to-line transformer which is a separate unit is furnished, also the connecting cable and 25' of special flexible cord with plug.

(NOTE: The separate transformer is approximately the same size.)

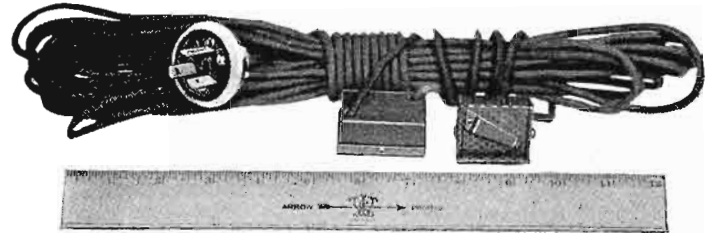

30-A Lapel Microphone

THE RCA sound power telephone provides convenient communication without the use of batteries between points separated by not more than a few miles. It may also be employed between control room and studio, to parts of the same building, for field use, or between transmitter building and antenna tuning house. Each handset consists of an electromagnetic microphone and a similar receiver mounted as a unit set with a line-off switch in the handle. No additional equipment is needed for talking because of the high level output of the microphone. Ringing circuits should be external. Thus a single pair of wires with two instruments will provide rapid and reliable service. The handsets are completely weatherproof. They are equipped with a short rubber covered cable and stowage hook. Weight each, $27\frac{1}{2}$ oz.

Microphone Accessories . . . Stands

◀ 90-A PROGRAM STAND

THE 90-A Program Stand is a new handsomely finished microphone stand, adjustable in height and designed for use with the 44-BX, 77-A, 77-B, 77-C, 88-A or 74-B microphones. It is of modern appearance, designed by John Vassos and its satin chrome finish will match with practically all studio decorations. By the use of a new, patented clamping device, the height of the stand may be changed without operation of any release mechanism. It may easily be lowered or raised, as desired, and will retain its position without chance of slipping. The clamp is one which is not subject to excessive wear and is simple and free from complications. Its base is equipped with equalizing projections to assure a firm position on an uneven floor.

SPECIFICATIONS

Adjustable in height from 44" to 73 $\frac{3}{4}$ " above the floor. Diameter of base 12 $\frac{1}{4}$ ". Finish: Satin chrome. Threaded to take microphones, standard $\frac{1}{2}$ " pipe thread. Cable guides included.



◀ 91-A ANNOUNCE PEDESTAL

A SIMPLE but attractive desk stand for 44-BX microphones. Finished in satin black. Diameter 7", height of 44-BX center above desk 8 $\frac{3}{8}$ ". For use with 74-B microphone, the AP-4234 adaptor should be ordered extra. With the adaptor, the stand will be 6 $\frac{13}{16}$ " in height.



MI-4068A LIGHT PROGRAM STAND ▶

THIS chromium and black stand is suitable for use particularly with the 74-B or 88-A microphones. It is equipped with a special clutch which eliminates thumbscrews and is adjustable in height from 35 to 67 inches. It is also useful for fixed remote installations. Fitting is for $\frac{1}{2}$ " pipe thread.



▼ THE 91-B DESK STAND

THIS is an attractively styled black and chromium base with a felt covered bottom. Two fittings are provided for using the stand with 88-A, 74-B, 77-B or 77-C microphones.



90-B BOOM MICROPHONE STAND ▶

THE RCA type 90-B Boom Microphone Stand will be useful to stations for piano pickups or wherever an extension is required for placing a microphone close to the source of sound. The 90-B stand has been carefully designed to present an attractive appearance, the form being simple and modern with a brushed chromium finish. A "streamlined" counterweight is included to compensate for the weight of either the 44-BX or the 77-A. The arm may be adjusted in height and will remain at the setting without clamping devices. Supports for the microphone cable are furnished along the length of the boom. In usefulness, appearance and lasting qualities, the 90-B will fill a long felt need for a sturdy boom microphone stand.

SPECIFICATIONS

Adjustable in height from 26 $\frac{1}{2}$ " to 73" above the floor. Length of boom 36 $\frac{1}{4}$ ". Diameter of base 15 $\frac{5}{8}$ ". Finish—Satin Chrome. Weight 75 lbs. Cable supports furnished. Threaded to take microphones, 44-BX or 77-A; standard $\frac{1}{2}$ " pipe thread.



◀ MI-4065-A BANQUET STAND

THIS smartly designed announce stand is designed for all of the RCA broadcast microphones except the aerodynamic for banquet or announce purposes. Finished in chromium and black. Takes $\frac{1}{2}$ " pipe fitting. Height 8 to 10 $\frac{1}{2}$ ".



59-A PORTABLE MICROPHONE STAND ▶

A STURDY, lightweight, collapsible stand for field use featuring a tripod base and maximum portability. Recommended for use with 74-B, 77-B, 88-A or 44-BX units. Several of these stands may be carried easily to a remote pickup broadcast. Weight only 3 lbs. May be extended from 32 $\frac{1}{2}$ " to 60" above the floor. Has $\frac{1}{2}$ " pipe thread.

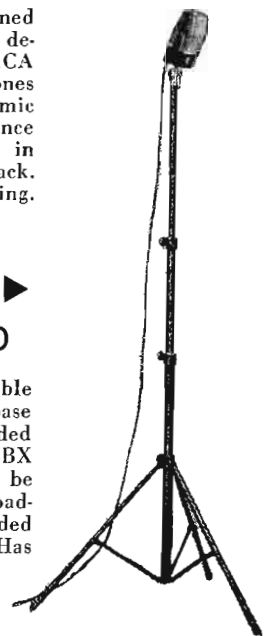

RCA Microphones

Type No.	Operation	Use	Output Level*	Output Imped.	Frequency Response	Finish	Fitting
44-BX Velocity	Velocity	Studio	-49 VU	50/250	30-15,000	Chromium & Black	1/2" Pipe Thread
74-B Junior Velocity	Velocity	Studio or indoor remotes	-51 VU	50/250 15,000	70-8,000	Chromium & Black	1/2" Pipe Thread
77-B Uni-Directional	Uni-Directional Velocity	Studio or auditorium	-55 VU	50/250	30-10,000	Chromium & Black	1/2" Pipe Thread
77-C Three-Way	Uni-Directional Bi-Directional Non-Directional	Studio or auditorium	-55 VU -58 VU -58 VU	50/250	30-10,000	Chromium & Black	1/2" Pipe Thread
88-A Pressure	Pressure	Remotes	-46 VU	50/250	60-10,000	Chromium & Black	1/2" Pipe Thread
MI-4015 Talkback	Pressure	Talkback	-39 VU	250	200-2,500	Chromium & Black	Complete with Stand
30-A Lapel	Velocity	Speakers	-75 VU†	250	80-7,000	Black	Clip
MI-6226-A Aerodynamic	Pressure	Talkback	-57 VU	250 40,000	100-6,000	Chromium	1/8" Pipe Thread

*10 dynes per sq. cm. sound pressure, open circuit.

†Proximity to source results in output levels corresponding to those of other microphones.

See page 156 for chart on VU vs. power level.

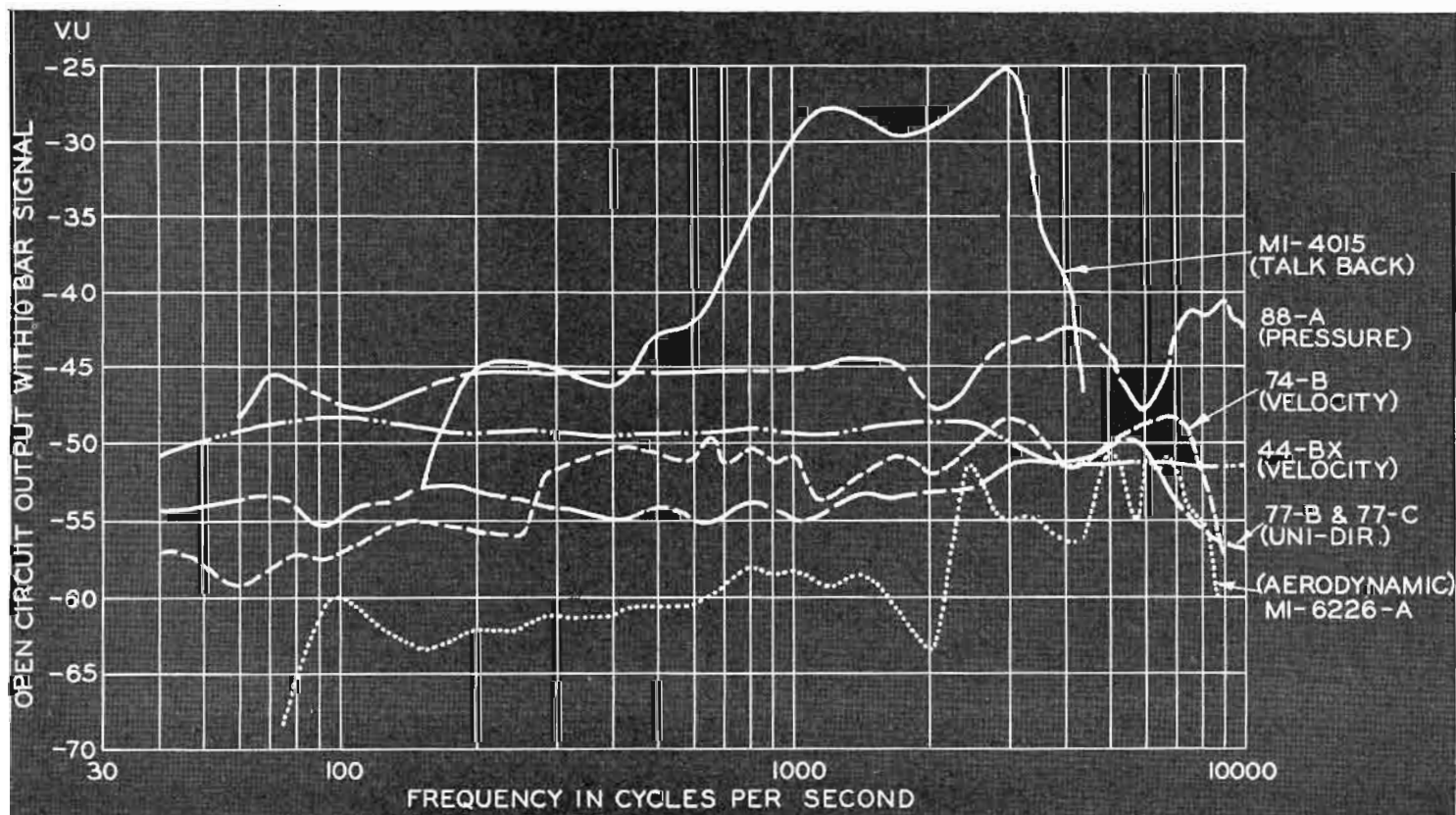

Frequency characteristic and relative output of RCA microphones



SPEECH INPUT EQUIPMENT



SPEECH INPUT EQUIPMENT

The speech input equipment described on the following pages includes not only every ordinarily-used type of equipment, but also, in most cases, more than one style or design. There are "custom-built" systems for special requirements, "factory-assembled" standard groupings, console and consolette type equipments, "deluxe" units, for those engineers who like to assemble their own "economy" units for lower-cost installations; and accessory units suitable for use in every station. All of these follow correlated design ideas, match closely in appearance, and combine most efficiently into complete installations.

RCA Custom-Built Speech Input Equipments are special combinations of RCA speech units, designed by RCA engineers, assembled and tested in the RCA factory exactly according to the requirements of the station for which they are intended. They insure maximum efficiency and convenience no matter how large or how special the installation. In network studio installations such custom-built equipments are a necessity,—in many larger stations they are almost equally desirable, and, in the long run, often less expensive.

★

RCA Factory-Assembled Speech Input Equipments are standard combinations of RCA speech units which have been assembled, and tested in the factory and are carried in stock complete and ready for shipment. Because of the advantages of standardization and quantity production, they represent a considerable saving in cost. For medium-sized stations they will be found ideally-suited. For smaller stations there are console and consolette type equipments offering still larger economies.

★

RCA Deluxe Speech Input Units, the units which form the basis of all RCA deluxe installations are also available separately. The list of these unit-panels includes one or more in every category. Together they provide for every operation of a speech input system,—and they may be easily combined to form any desired arrangement of single or multiple channels. The finest equipments yet devised, they guarantee maximum performance, reliability and convenience under all conditions.

RCA Standard Line Equipment includes several apparatus units which combine the advantages of "network" type apparatus without the hinged chassis feature and without the styling which has been used on the deluxe line. Such familiar units as the 41-B preamplifier and 40-C program amplifier which have achieved an enviable reputation in the field are included in this line. These units are in every day use in leading broadcast stations and have proved satisfactory under severe operating conditions.

★

RCA Economy Speech Input Units constitute the "junior" line of RCA studio equipments. Designed to enable stations to achieve high-fidelity transmission without exceeding limited budgets, they lack some of the convenience and appearance features of the deluxe line but are, nevertheless, built to RCA standards,—which means that they are reliable, efficient and capable of true broadcast quality.

★

RCA Speech Input Accessories, include transcription turntable equipments for reproduction of both lateral-cut and vertical-cut recordings, recording equipment, including records, and equipments designed for remote pickup use. Designed by the same engineers, these equipments have application and performance characteristics comparable to the RCA speech units proper—and may, therefore, be used with these to form coordinated installations of maximum efficiency.

CUSTOM-BUILT INSTALLATIONS

RCA "Custom-Built" equipments are complete speech input systems designed according to the requirements and specifications of individual stations. While standard panels and units are used, for the most part, in assembling these systems,—and the accumulated experience of RCA engineers, in building many such systems, called upon in their design—nevertheless, each system is different in one or more particulars. No two broadcast studio layouts are just alike,—and never, except perhaps in the smallest stations, are the equipment requirements exactly the same. Moreover, the bigger the installation, the more specialized the equipment problem. Similarly the more advanced the station engineer's ideas, the greater the ingenuity required to meet them. But, however large, or however modern, may be the requirements, RCA "Custom-Built" equipments can be furnished to meet them.

Moreover, the "Custom-Built" service means more than just so many racks or pieces of equipment,—it includes, in fact, the services of the whole RCA engineering organization. These services may be utilized by broadcast stations to almost any extent desired. In some cases, for instance, the station or network engineers may wish to lay out the system themselves, complete with specifications. In such instances, RCA engineers will assemble standard units and, where necessary, specially-built units to meet these specifications in every detail. On the other hand, where stations so desire, RCA engineers will themselves study the requirements of the station, make overall and detailed layouts, and draw up specifications for the needed equipment.

RCA CUSTOM BUILT INSTALLATIONS

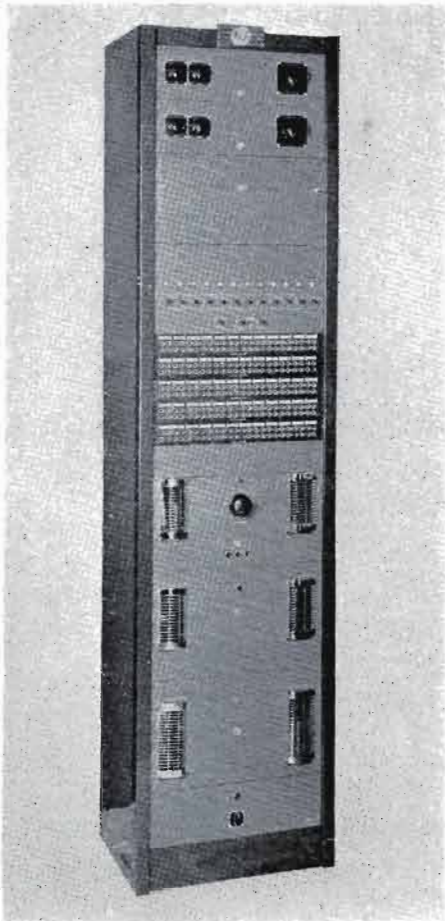

*Line Terminating Rack at WHBC,
Canton, Ohio.*

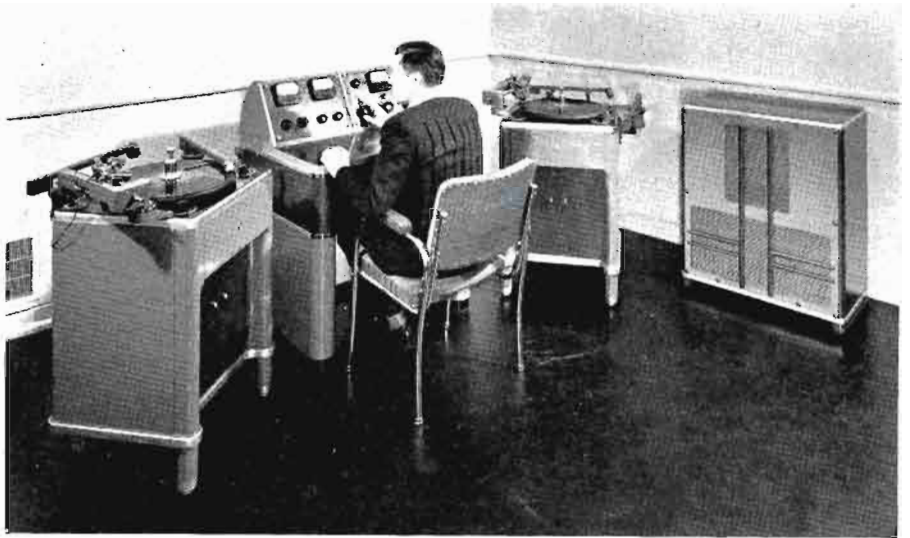

*Transcription Turntables, Monitoring Loudspeaker and Control Console installed at
the Golden Gate Exposition.*

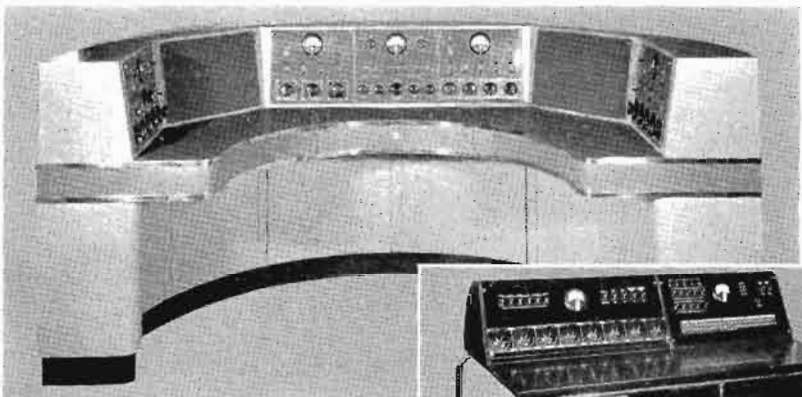

▲ *Master Control Desk,
WWNC, Asheville,
N. C.*

▶ *A modified 80-A Desk
for Canadian Broad-
casting Company.*

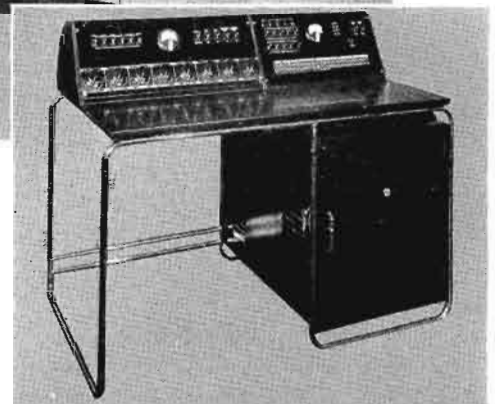

*A Studio Control Console and Rack built for WFBR,
Baltimore, Md.*

*An RCA installation for the Department of Interior. ▶
Note the shelves on the speech input.*

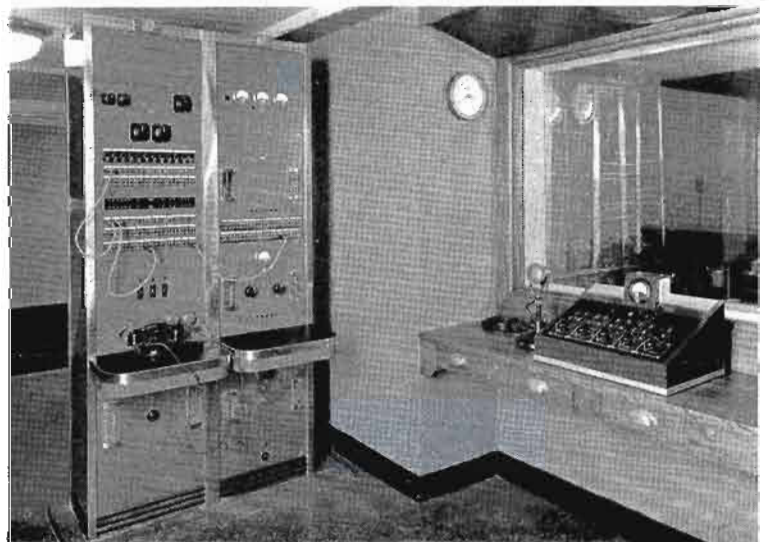

RCA CUSTOM BUILT INSTALLATIONS

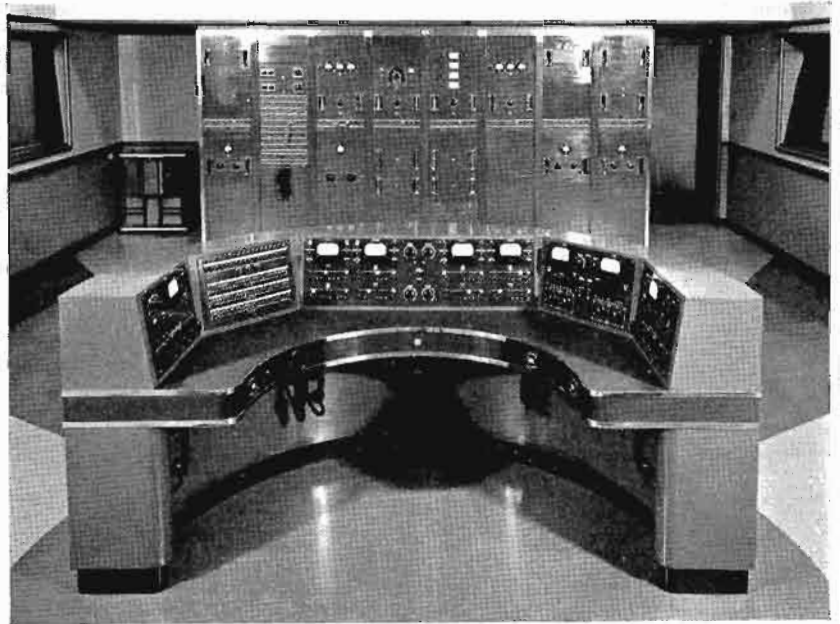
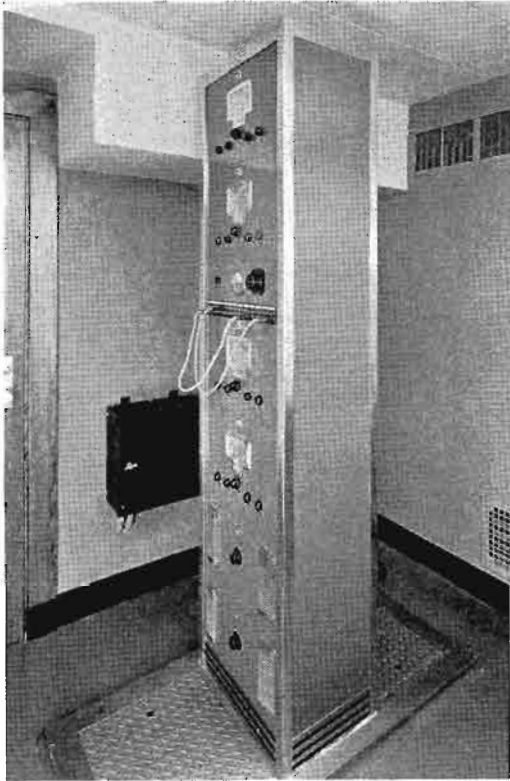

Speech Input Master Control Desk, Racks and Monitoring Loudspeaker installed at WFBR, Baltimore, Md.

◀ *A custom built Speech Input Rack installed for the Department of Interior.*

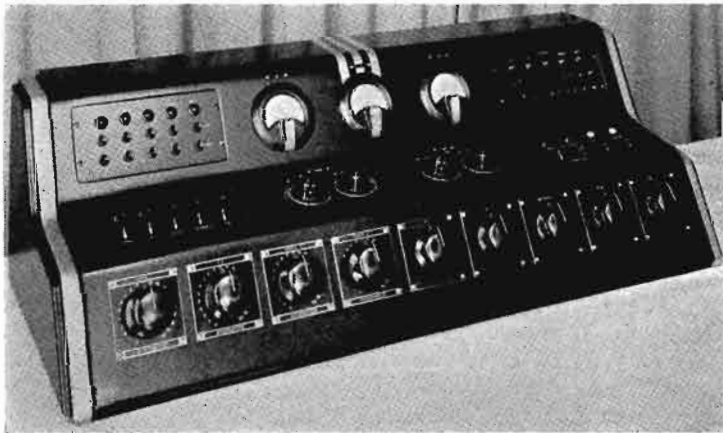

Master Control Console at WHBC, Canton, Ohio.



The RCA 78-C Equipment in the Control Room of Studio 2 at Columbia's WCCO.

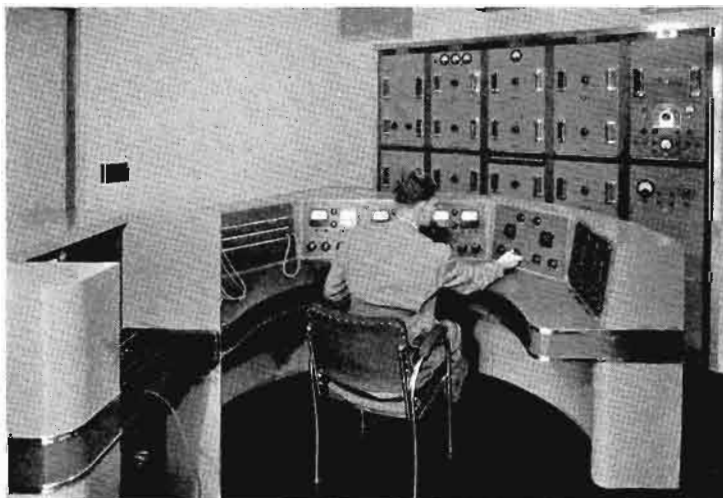

◀ *Speech Input Master Control Desk and Racks employed at the Golden Gate Exposition.*

RCA FACTORY-ASSEMBLED SPEECH INPUT EQUIPMENTS

RCA "Factory-Assembled" Equipments are complete speech input equipments; assembled with standard units in the factory; wired, by expert wiremen; and tested, as complete equipments, before shipment. They differ from the "Custom-Built" equipments in that they are not built to individual station requirements but are, rather, standard groupings assembled in quantity and carried in stock ready for immediate shipment.

While studio layouts, even of small stations, do vary considerably, experience indicates that one of three or four standard speech input assemblies will meet the requirements of most of the single-studio or two-studio installations. By producing these standard assemblies in quantities it is possible to include extra facilities which provide sufficient flexibility to meet most of the requirements particular to the individual stations—and still offer a saving over the average cost of assembling and wiring units in the field. Moreover, this plan makes available to small stations that assurance particular to factory-assembled and tested equipment—viz, certainty of matched overall performance, of maximum reliability, and of optimum conformance to accepted operating practice—an assurance otherwise available only in the relatively more expensive "custom-built" equipment.

The several types of factory assembled equipment listed offer a considerable choice—both as to the extent of the facilities included and as to the style and appearance. They are all, however, alike in one outstanding respect; namely, that they are made up

almost entirely of standard panels and units. Thus they not only obtain the economies resulting from quantity production of these units, but they also retain the important advantages—of standardization, of proved design, and of provision for future expansion—which are inherent in unit-type equipments. RCA Assembled Equipments are almost alone in providing this feature.

In quality of workmanship and materials, in perfection of performance, and in reliability, these RCA equipments are similarly outstanding. Moreover, the circuits employed, the arrangement of units and the details of design have been given careful attention by audio engineers who specialize in broadcast design. For more information along these lines, reference should be made to the separate descriptions which follow.

One thing about these equipments in general should be noted. Since the economies they represent depend on standardization and quantity production, modifications cannot be made except at added cost. However, minor changes can be easily made in the field and RCA engineers will be glad to make suggestions along this line. Moreover, it should be noted that the particular assemblies here listed are merely those which were in production at the time this catalog was printed. From time to time, as the demand arises, new assemblies will be added to this line—so that stations not finding just what they want among these are invited to seek additional information from the nearest RCA district office.

TWO-STUDIO SPEECH INPUT EQUIPMENT

Type 78-B1

THE TYPE 78-B1 Speech Equipment is a factory-assembled grouping of deluxe type panels, intended for use in the control rooms of small and medium-sized stations and for other applications requiring similar facilities. It consists of three units; a cabinet type rack on which are mounted the standard panel units which make up the systems; a sloping-front operator's console containing all of the mixing and switching controls; and a small wall-mounting unit which furnishes the 12 volt d.c. supply for the relays. The rack and console units are shown on this page. The streamlined and attractive appearance of these will be evident. Their modern "functionalized" design places unusual emphasis on efficiency in application, flexibility in location, and convenience in operation. In transmission fidelity they are unexcelled.

All of the unit panels used in the 78-B1 are of the deluxe type—and more detailed descriptions of these will be found on later pages. In addition to the 41-C Three-Channel Program Amplifier and the 40-D Program Amplifier and the 94-D Monitoring Amplifier, there are two 33-A Jack Panels, a 57-A Switch Panel and a special relay panel. On the console are the four mixers, the main gain, the V. I. meter, and sixteen key switches. A plate current meter is mounted on the 40-D panel.

The outstanding feature of the 78-B1 is its provision for two-studio operation—including means of auditioning simultaneously with program transmission. A separate interlocked talk-back microphone is available for talking into either studio. A three-position switch allows the monitoring system to be placed across the program

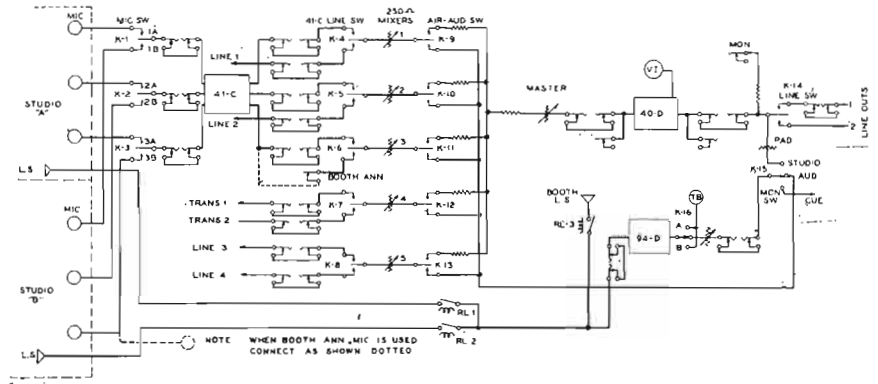

line output for regular monitoring; or, across a remote "cue" or transmitter output monitoring circuit.

The use of standard jack strips and a rack makes the 78-B1 very flexible for emergency setups or the addition of new equipment as required.

SPECIFICATIONS

Input Impedance:

- Microphones (6) 50 and 250 ohms
- Line and Transcription (6) 250/300 ohms
- Talk Back Microphone (1) 500 ohms

Output Impedance:

- Line (2) 500/600 ohms
- Speaker (3) 15 ohms

Output Levels:

- Line +6 db.* normal
+18 db.* maximum
- Speakers 12 watts normal
17 watts maximum

Gain:

- Microphone to Line 101 db. maximum
- Microphone to Speaker (Monitor) .. 133 db. maximum
- Microphone to Speaker (Audition) .. 108 db. maximum
- Transcription to Line 55 db. maximum
- Transcription to Speaker (Audition) . 62 db. maximum
- Talkback to Speaker 75 db. maximum

Frequency Response:

- Microphone to Line,
-1 to +2, 30 to 10,000 cycles
- Microphone to Speaker,
+2 db., 30 to 10,000 cycles

Distortion:

- +6 db.* to Line,
less than 1% RMS, 50 to 7500 cycles
- 12 watts to Speaker,
less than 2½% RMS, 50 to 7500 cycles

Noise:

- 60 db. below normal output with normal gain settings

Power Input:

- 105-125 volts, 50-60 cycles, 250 watts

Finish: Black or Two-Tone umber gray

* Zero level=12½ milliwatts

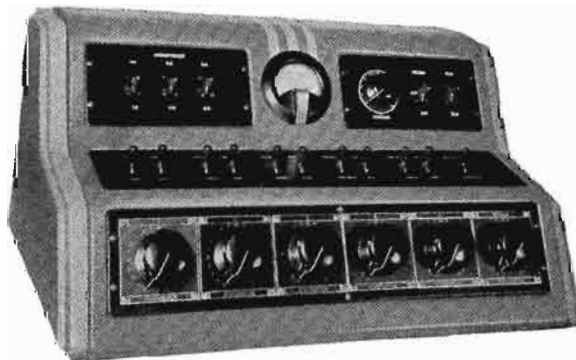
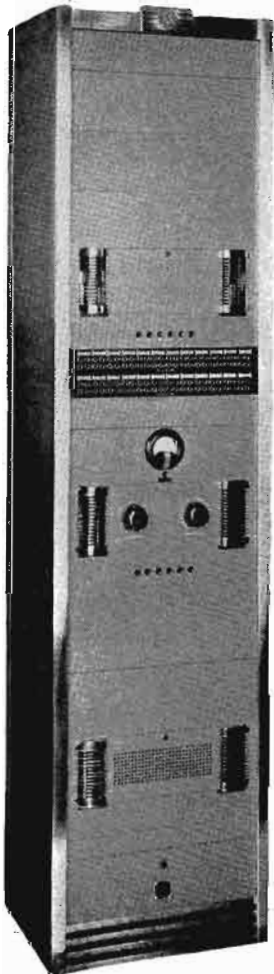

SINGLE STUDIO SPEECH INPUT EQUIPMENT

Type 78-C1

THE TYPE 78-C1 Studio Equipment is a deluxe assembly which is very similar in layout and appearance to the 78-B1 Equipment previously described. It differs, chiefly, in that it is arranged primarily for single studio operation. As such it is suitable for use in the individual studio booths of larger stations and in some cases in small station control rooms.

Like the 78-B1 it composes a standard cabinet type rack on which are mounted the unit panels, an operator's console and a relay rectifier.

Operating and switching arrangements of this equipment are shown in the diagram below. As will be noted, these amount to a simplified version of the 78-B1. The audition switching circuits are, of course, omitted, as are also the

microphone input switches and there are only five mixer-input positions. However, talkback, cue and monitoring facilities are retained in full and in general the same degree of convenience and flexibility is provided. For those applications where only a single studio program is to be handled this equipment is unexcelled in any respect and is now being used by several prominent stations.

The 78C-1 can be easily arranged for four microphones by the addition of a 41-B Pre-amplifier for which wiring has been provided. A filter and switch permit the pre-amplifiers to obtain their plate voltage from the monitoring amplifier for emergency operation should a failure develop in the program amplifier. The high gain and excellent operating characteristics of the 94-D Monitoring Amplifier make it ideally suited for emergency use to replace the program amplifier and it may be quickly patched for this service.



SPECIFICATIONS

No. of Microphone Inputs: Three (50/250 ohms). No. of Other Inputs: Two, for additional microphone, transcription or line input. No. of Output Lines: (500 ohms) two. No. of Speaker Outputs: (7½ ohms) three. Overall Gain: 101 db. Normal Output Level: 0 db. Maximum Usable Output: +18 db. Frequency Response: ±1 db., 30 to 5000 cycles. Rises to 3 db. at 12,000 cycles. Output Noise Level: (at normal level)—60 db. Distortion: (at normal level) 0.8 of 1%. Power Required: 105/125 volts, 50/60 cycles, 310 watts. Dimensions of Rack: 82⅞" high, 14⅜" deep, 20⅝" wide; Console, 25" wide, 15" deep, 12" high. Weight: Rack, 500 lbs., Console, 50 lbs., 0 db. = 12½ milliwatts.

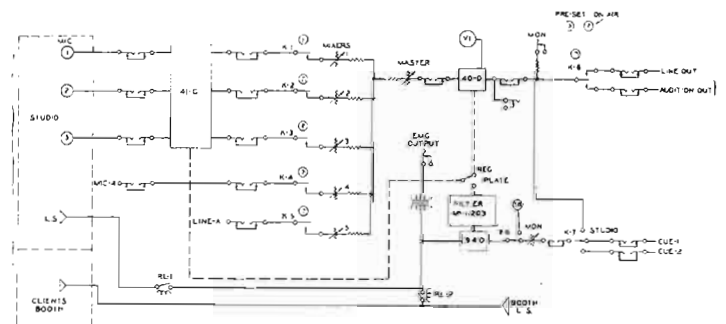
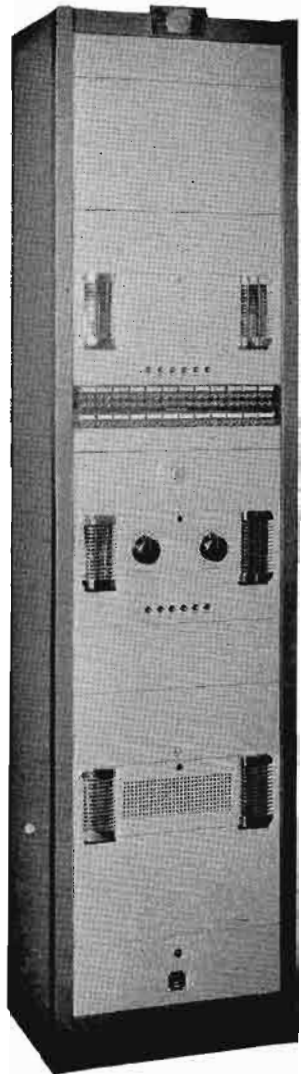

RCA TWO STUDIO CONTROL DESK Type 80-A

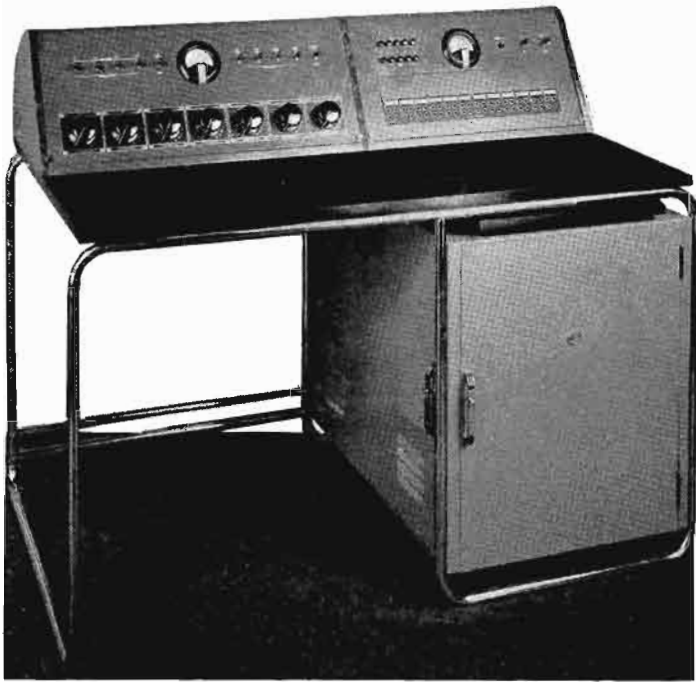

IN THE 80-A desk, RCA has designed a unique speech input system for the station desiring the maximum of performance and appearance at a relatively low cost. With the 80-A desk it is possible for one operator to handle efficiently two full sized studios and a transcription booth. In addition, all the switching and equalizers necessary for handling a remote program from any one of five incoming lines is included. Any combination of studios and remotes may be used on the air while any other combination may be instantly switched to the audition loudspeakers. Full talkback facilities are provided from the control room to either of the two main studios. An emergency plate supply for the preamplifier is obtained from the monitoring amplifier. Standard double-jacks are connected in all the principal audio circuits. A new switching system permits "cue" to be fed back on any of the remote lines so the remote operator will know exactly when to start his broadcast. Complete metering is provided for all tubes in the program channel. Full-sized, standard RCA amplifiers are used throughout.

The completed desk is about the size and shape of a modern frame desk. It is beautifully finished in black, chromium and umber gray. The switches and controls are mounted on panels in a metal turret comprising the upper part of the desk. The control panels remove for easy servicing. All meters and control knobs are at the proper angle and height for convenient operation. The rear of the turret control is rounded to provide visibility into the studio. The left hand control panel contains the mixers, the illuminated VI meter and all the program circuit key switches. The VI meter also indicates plate currents. The monitoring volume control, the monitor selector switch, the remote line program and cue selector switches, and a double jack strip are mounted on the right hand panel.

A sliding writing shelf is mounted in the right hand side of the desk for the convenience of program directors and others. Below the shelf is a ventilated metal compartment which houses all the amplifiers and relays.

Four RCA Type 85-A single tube preamplifiers are used

ahead of the mixers. Two additional 85-A's are utilized as booster amplifiers; one in the program circuit before master gain control and the second in the audition circuit preceding the monitoring volume control. A Type 84-A Program Amplifier completes the program channel and a Type 82-A Monitoring Amplifier is used. The monitoring amplifier is capable of furnishing 110 Volts, D. C. field supplies to three loudspeakers.

SPECIFICATIONS

Gain (Maximum): Microphone to Line, 107 db. Transcription Turntable to Line, 77 db. Line to Line, 66 db. Microphone to Speaker (Audition), 101 db. Turntable to Speaker (Audition), 76 db. Talk-back to Speaker, 86 db.
Gain Controls: 250-ohm step-by-step ladder-pads for mixer and master controls.

Input Impedance: Microphone, 250 and 30 ohms, balanced. Transcription, 250 ohms, unbalanced. Line, 250 and 500-600 ohms, balanced. Talk-back, 250 ohms, balanced. Cue, 10,000 ohms, balanced.

Output Impedance: Line, 500-600 ohms, balanced. Monitor, four 15-ohm speakers.

Output Level: Line, +10 db., normal; +20 db., maximum. Monitor, 4 watts, normal; 8 watts, maximum.

Distortion: Line, less than 1% RMS at normal output, over band between 50 and 7,000 cycles. Monitor, less than 2.5% RMS at normal output, over band between 50 and 7,000 cycles.

Noise Level: With normal gain-settings, minus 60 db.

Frequency Response: Line, $\pm 1\frac{1}{2}$ db., from 1,000-cycle response, between 30 and 10,000 cycles. Monitor, $\pm 2\frac{1}{2}$ db., from 1,000-cycle response, between 30 and 10,000 cycles.

(Note: the monitor may be compensated +6 db. at 60 and 10,000 cycles if desired.)

Power Supplied to External Devices: 110 volts D.C., for one to three 100-milliamperere loudspeaker-fields. 12 volts D.C., for "ON AIR" light relays.

Power Input: 105-125 v., 50-60 cycles A.C., 250 w., 90% P.F., includes 30 watts for speaker fields.

Tube Complement: 8, RCA-1603; 1, RCA-6C6; 2, RCA-89; 2, RCA-76; 2, RCA-6L6-G; 1, RCA-80; 1, RCA-5Z3; 1, No. 289415-C Rectigon.

Weight: Desk, 200 lbs. Relay Rectifier, 17 lbs.

Dimensions: Desk, height, table 30", overall 40 $\frac{1}{2}$ "; width 50"; depth 30". Rectifier, height 10", width 8", depth 5".

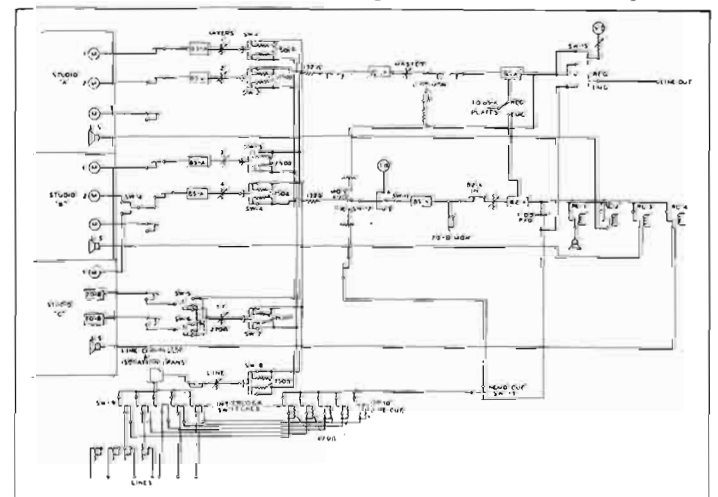

RCA SINGLE STUDIO CONTROL DESK

Type 80-B

THE TYPE 80-B Control Desk is similar to the 80-A except that it has been primarily designed for single studio operation. Thus it fulfills the need of a complete studio control booth equipment for stations using several studios and a master control room. It is also useful for installations in play houses and remote studios. All the switches which are required for the multiple studio operation of the 80-A have been omitted in the 80-B. A double-throw key switch on the input of each of the four preamplifiers permits switching to studio microphones, turntables or remote lines. A monitoring cue selector switch permits the operator to choose his cue from the preceding program on his individual channel.

The 80-A and 80-B desks are small enough to permit a convenient installation in a rather small control room and large enough to permit the use of standard size components. Only a chair and a loudspeaker are required to completely equip a control room when the 80-A or 80-B desks are used. Matching chromium finished tabular steel chairs are readily obtained and present an attractive modern appearance in the control room.

A unique feature of the 80-B is the inclusion of a switching and a jack circuit for quickly substituting the monitoring in place of the program amplifier for emergency operation. The monitoring amplifier power supply may likewise be switched to feed the preamplifier should such operation ever be required.



SPECIFICATIONS

Same as 80-A, except for the following: Gain (Maximum): Microphone to Line: 110 db. Line to Line: 80 db. Cue to Speaker: 28 db. Line out to Speaker (Monitor) 28 db. Talk-back to Speaker: 80 db. Tube Complement: 7, RCA-1603; 1, RCA-6C6; 2, RCA-89; 2, RCA-76; 2, RCA-6L6-G; 1, RCA-80; 1, RCA-5Z3; 1, No. 289415-C Rectigon.

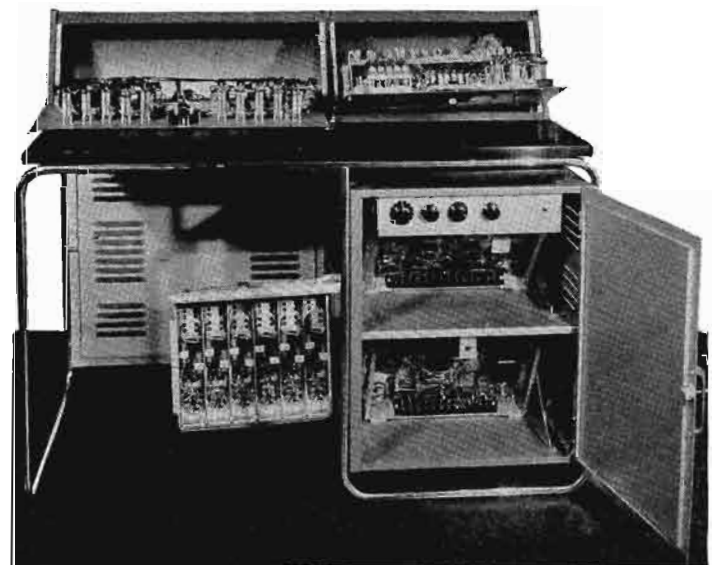

Interior view of 80-B Desk showing accessibility to all amplifier chassis. Pre-amplifiers swing out for servicing.

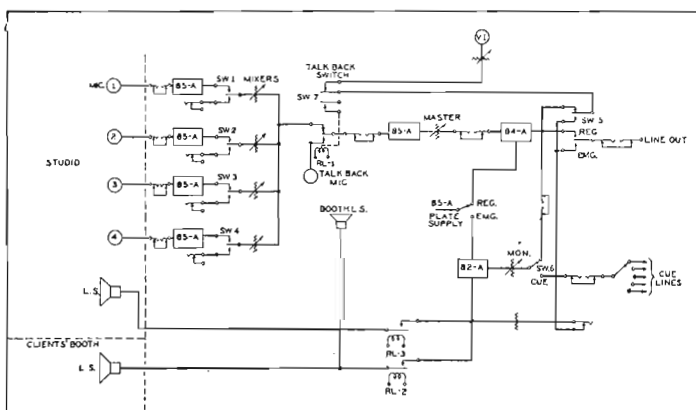

CONSOLE SPEECH INPUT EQUIPMENT

Type 76-B



THE RCA 76-B has been designed to provide a complete and flexible speech input system for maximum economy. It provides all the amplifying and control equipment required to successfully handle two studios, an announce and transcription booth, and six remote lines. All the amplifying and control equipment is mounted in a single console and two power supplies are located in an external box which may be floor or wall mounted.

Full facilities are provided for simultaneous auditioning and broadcasting of any combination of studios, turntables or remote lines. A separate talk-back microphone may be instantly switched to either of the studios or remote lines. The talk-back and cueing circuits are interlocked with the microphone keys to prevent feed-back. A six position mixer is utilized with preamplifiers connected to four of the mixers and banks of mechanically interlocked push keys connected to the remaining two. A switch in the input to the fourth preamplifier permits the use of one announce microphone in the control room and another in an announce or transcription booth. The push-keys on the fifth and sixth mixer positions allow any one of six remote lines (through pads and transformers) or two turntables to be instantly connected to either of the two mixers.

Additional push-key sets provide circuits for feeding cue out on remote lines or bringing in monitoring circuits from a transmitter output or from a master control.

Switching facilities are included for instantly using the monitoring amplifier in place of the program amplifier should an emergency arise. Two power supplies are used and the preamplifier may be switched to obtain their plate voltage from either of them. The 76-B power supply also furnishes operating voltage for external studio "on air" light relays.

The newly standardized illuminated volume indicator meter is furnished and the calibration is in "VU's". New lower priced high quality speech input metal tubes are used for maximum performance and economy.

Both the console and power supply have hinged chassis and covers which permit easy and quick accessibility to every part and connection.

The units are finished in the new RCA two-tone umber grey lacquer.

SPECIFICATIONS

Input Impedance:

Microphones (5)	50 and 250 ohms
Lines (6)	300 and 600 ohms
Turntables (2)	250 ohms
Talkback (1)	250 ohms
Monitor Cue (5)	20,000 ohms

Output Impedance:

Line (1)	500/600 ohms
Speaker (3)	15 ohms each

Output Level:

Line	+10 VU. normal, +28 VU. max.
Monitor	4 watts normal, 8 watts max.

Maximum Gain:

Mic. to Line	110 db.
--------------------	---------

Frequency Response:

Mic. to Line, $-\frac{1}{2}$ to $+\frac{1}{2}$ db.,	30 to 10,000 cycles
Mic. to Speakers, ± 2 db.,	30 to 10,000 cycles

Distortion:

Line	Less than 1% for normal output
Monitor	Less than $2\frac{1}{2}$ % for normal output

Noise Level:

-60 db. below normal output

Power Input:

105-125 volts, 50-60 cycles, 225 watts.

Tube Complement:

11-RCA-1620, 2 RCA-1621, 2 RCA-1622, 1-RCA-5Y4G, 1 RCA 5V4G.

Size:

Console, 39" long, 17" deep, $10\frac{1}{2}$ " high
Power Supply, 15" long, 8" deep, 15" high

Weight:

Console, 135 lbs.
Power Supply, 60 lbs.

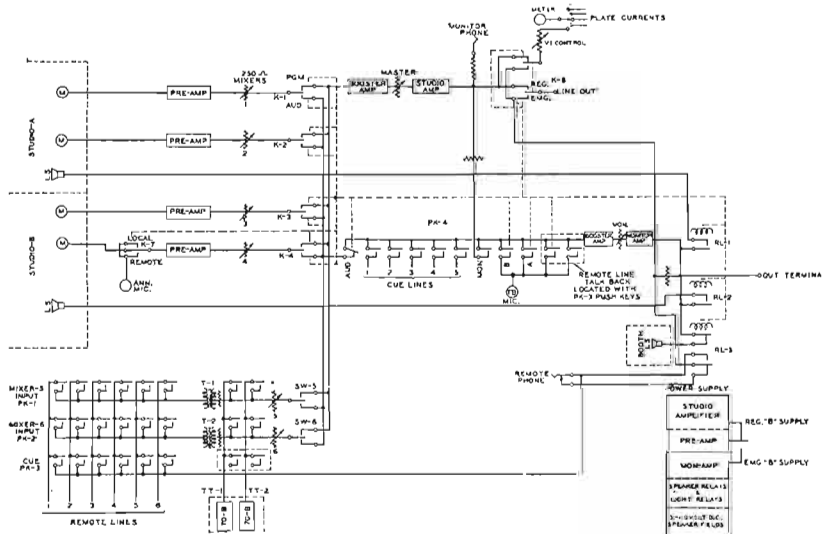

Block diagram of RCA 76-B Console

ASSEMBLED MIXING CONSOLES

Type 81-A *Double Studio*

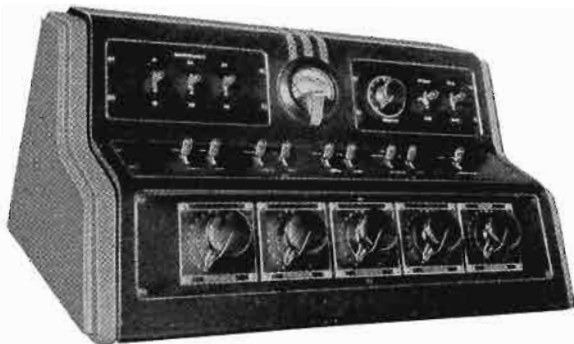

THE TYPE 81-A operator's console is a completely assembled and wired unit providing a four position mixer (plus a master) with a switching circuit similar to that shown for the 78-B1 on page 24. It is intended for use with three preamplifiers and provides switching for connecting the inputs of the preamplifiers to three microphones in each of two studios. Each mixer has a key in its input which permits the first three mixers to be connected to the preamplifier outputs or to lines. The fourth mixer has an input key for switching between two turntables. A key in the output of each mixer permits switching it to either the air or audition channels. Additional keys are provided for switching the program amplifier's output to either of two lines, for talking back into either studio, and for switching the monitor amplifier's input to (1) the program amplifier's output, (2) the output of the mixer's set for audition, and (3) an external cue such as a monitoring output from a transmitter. Rectifier or DC type VI meters are available.

Type 81-B *Single Studio*

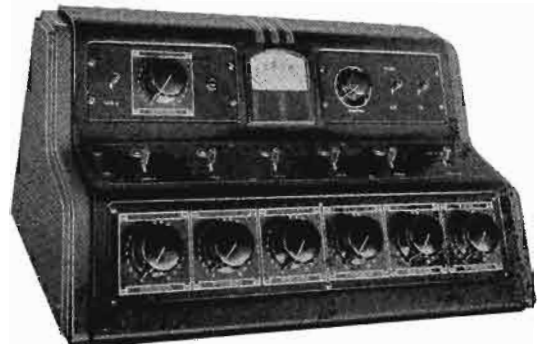

THE 81-B console was designed for use in the control booths for individual studios. It contains a six position mixer with an "off-on" switch and indicating lamp in the input circuit of each mixer. It is intended for use with four preamplifiers and the two additional mixers are used for lines or turntables. Step-by-step ladder pads are used for the six mixers and the master attenuator. A line out key switches the output of the program amplifier between two outgoing lines. A talk-back key is provided. A monitor key switches between the output of the program amplifier and an external cue circuit.

As with the 81-A, the cabinet design has been made for a maximum operating ease and serviceability. The mixer and VI panels have a 60° slope to provide good visibility and operating convenience. The key panel is almost horizontal in order to reduce the overall height of the unit. The entire front panel is hinged at the top rear which permits easy and quick servicing of all attenuators and switches. Shielded, twisted-pair, wiring is used and a wiring diagram is furnished. Various types of VI meters are available. The color is grey and black—and the dimensions are 25 in. wide, 15 in. deep and 12 in. high. The weight is approximately 50 lbs.

WALL MOUNTING JACK AND EQUALIZER CABINET

Type MI-11500

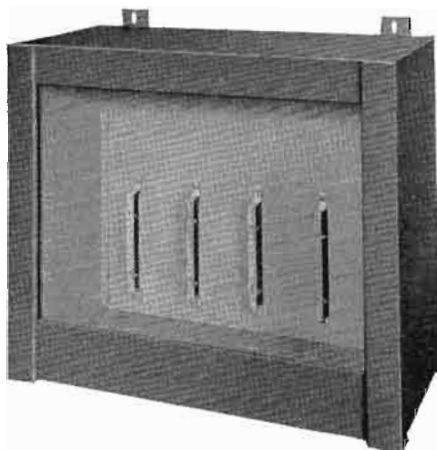

For speech input, installations utilizing consolettes or where the present facilities will not permit expansion, it is often desirable to have several jack strips and one or two variable line equalizers for terminating, patching and equalizing the remote lines. To fill this requirement the MI-11500 cabinet has been designed. It is for wall mounting and provides mounting space for 4 type 33A double jack strips, and one 56-E two channel variable line Equalizer panel—33-B jack strips may be used if preferable. There is sufficient space inside the cabinet for 4 terminal blocks. The overall dimensions are 20½ in. wide, 9⅝ in. deep and 19¼ in. high. The finish is umber-grey.

DE LUXE SPEECH INPUT UNITS

THE RCA Deluxe Line of speech input equipment has been designed to provide stations with studio equipment which would offer the maximum in fidelity, flexibility, convenience and reliability. While the apparatus is truly deluxe in performance and appearance, it is not expensive considering the many features which are offered. It has been designed primarily for unsurpassed service and nothing has been omitted which would contribute to usefulness and reliability, yet cost has been watched carefully in order to provide the desired features without excessive expense.

The deluxe amplifiers feature fidelity of the highest order. Frequency response is uniform, not only over the usual range to 10,000 cycles; but well beyond. Distortion has been reduced to a point which would have been considered impossible for commercial apparatus a few years ago—note the curve shown below. Noise level is well below -60 db. Thus the apparatus provides for incomparable fidelity standards which are not likely to be exceeded by any commercial equipment for many years.



Typical RCA DeLuxe Front Panel, Chromium
Lowers Enhance Appearance and Provide
Additional Ventilation

But fidelity is not the only consideration. Reliability is particularly important to stations deriving income from the sale of time. One interruption, particularly when several stations are receiving the same program, may cost far more than the apparatus. Therefore, the equipment has been provided with components which are unusually heavy and which have a larger factor of safety than normal. Resistances and capacitors are the best which can be obtained for the purpose, tested under conditions which assure trouble free service. Transformers are large in order to avoid low frequency distortion and are provided with particularly efficient shielding. Gain controls are all of the tapped type with individual fixed

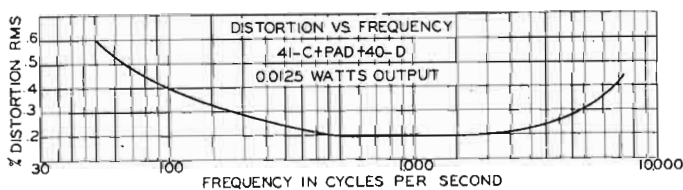
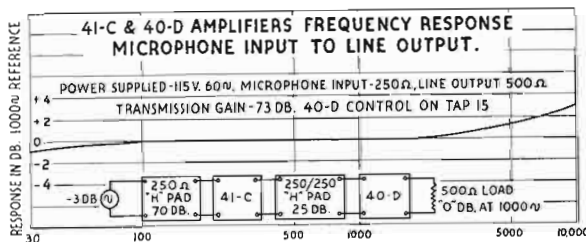

Curve showing distortion vs. frequency 41-C + Pad + 40-D

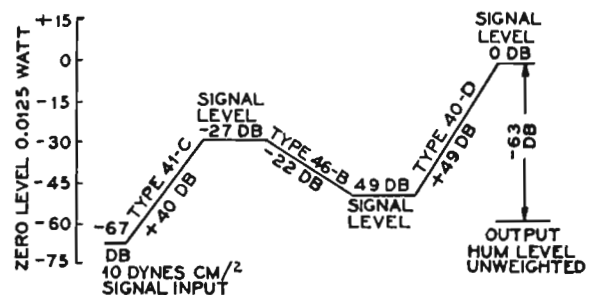

Signal levels for deluxe system



Rear View of 78-B Rack Showing Perfect Accessibility

resistor units constructed to avoid noise during operation and tested for thousands of cycles of use. Every detail has been carefully considered from the standpoint of reliability and long life.

Convenience plays an important part also. Most

of the deluxe units are supplied with hinged chassis units which allow the entire unit to be tipped to the rear, exposing the under portion for inspection. Thus it is unnecessary to remove the panel from the rack once it has been connected up. Tubes are easily reached through a door in the front panel. Meters are of the illuminated type with easy access to the lamp. Plate currents of tubes can be read by operating push-buttons. Even the terminal strips are of a type which facilitate wiring.

Appearance has been considered important to increase the prestige of the station. The front panels are treated with chromium styling which also forms louvres to furnish ventilation and to keep all parts at a conservative temperature. Chassis and components are heavily plated to provide an attractive appearance and to prevent dust from sticking. Panel finish is uniform and of the highest grade.

Thus the deluxe units represent the finest speech input equipment it is possible to obtain. While the cost is somewhat greater than for other lines, it is represented in value — greater safety factor, heavier materials, more expensive and better components as well as showmanship in appearance and highest fidelity. Stations desiring equipment which makes no compromise in performance may buy this apparatus in unit form, building up as the occasion demands. Used extensively by network stations the RCA DeLuxe Line finds universal acceptance among stations large or small who appreciate fine quality apparatus.

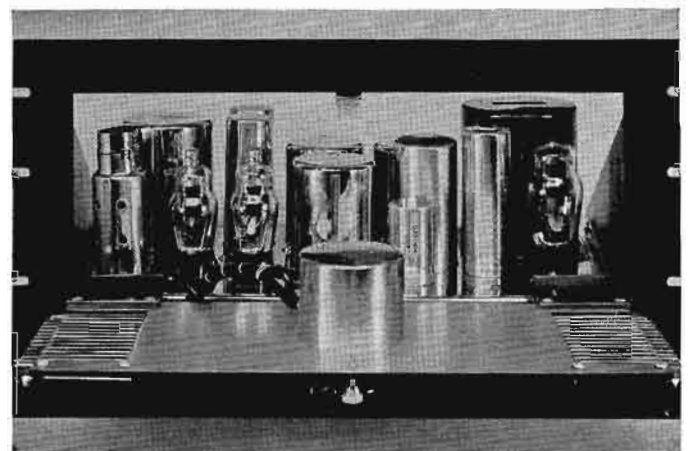

Front View of DeLuxe Type Amplifier (55-B) With Door Opened. Notice Accessibility of Tubes and Volume Control

THREE-CHANNEL PRE-AMPLIFIER

Type 41-C

A DeLuxe Unit Incorporating Three Complete Pre-Amplifier Channels

ALL of the high-quality microphones developed to date have relatively low output and are, therefore, ordinarily used with preamplifiers designed to raise these outputs to a satisfactory mixing level. The Type 41-C Preamplifier is a unique unit which provides the preamplification facilities ordinarily needed for a complete speech input channel. It contains three separate preamplifiers, each complete and independent of the other, save for power supply. These preamplifiers may be used exactly as if they were three separate units. Since the usual speech input channel consists of three microphone inputs, plus transcription and line inputs—which do not require preamplifiers—the Type 41-C should take care of all ordinary needs.

Prime requirements in a preamplifier are low noise-level and freedom from microphonics. In the Type 41-C these are assured by use of RCA-1603 "low-noise" tubes, provision of extra-large bypass condensers, and by shock mounting of tubes. Each preamplifier channel consists of two stages—RCA-1603's triode-connected. Taps are provided so that the gain of each channel may be set at either 42 db. or 48 db. Input impedances of 50 ohms or 250 ohms are available from alternate connections.

Characteristics of the Type 41-C Preamplifier are exceptional. The frequency response is flat from 30 to 5,000

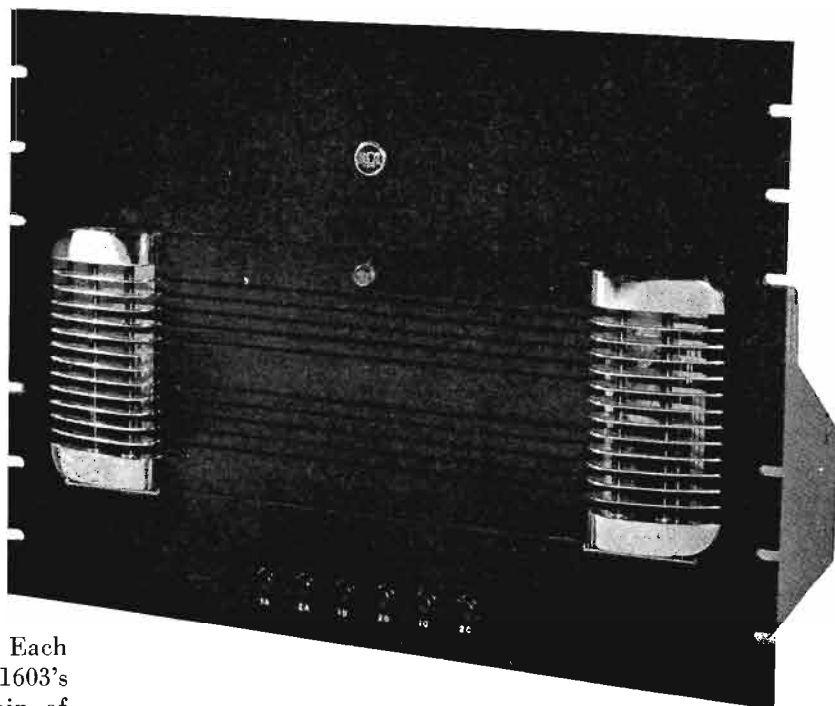

cycles, and beyond 5,000 cycles rises gradually to 16,000 cycles. This provides for an overall characteristic (of the channel when used with the Type 44-B Microphone) uniform from 30 to 17,000 cycles. Distortion is less than 0.2% arithmetic sum, while the noise level (unweighted) is $-98\ddagger$ db. in the low-gain position, and $-90\ddagger$ db. in the high-gain position. The Type 41-C Preamplifier has input impedances to match any high-quality microphone. In addition to the normal high-fidelity characteristics, consideration has also been given to the necessity of providing a wide dynamic range without overloading. Thus an input of 400 bars (which, with the Type 44-B Microphone, would result in an output of -3 db.) can be handled without exceeding ordinary distortion limits. This is an important factor wherever programs rising to high levels are to be met with.

SPECIFICATIONS

No. of Channels: three. Input Impedances: 50/250 ohms. Output Impedances: 250/500 ohms. Gain (Each Channel): 42/48 db. Normal Output Level: -16 VU db. Max. Usable Output: 0 VU. Output Noise Level: (unweighted) $-87/79$ VU. Distortion (Arith. Sum): at normal output, 0.2%. Frequency Response: 30 to 15,000 cycles. Power Required: 6.3 volts, 1.8 amp.; 180 v., 12 m.a. (180 v. obtainable from 40-D or 40-C). External filament transformer supplied. Panel Height: $13\frac{3}{8}$ ". Weight: 61 lbs. Tubes: 6 RCA 1603.

\ddagger 0 db = $12\frac{1}{2}$ milliwatts = +11 VU

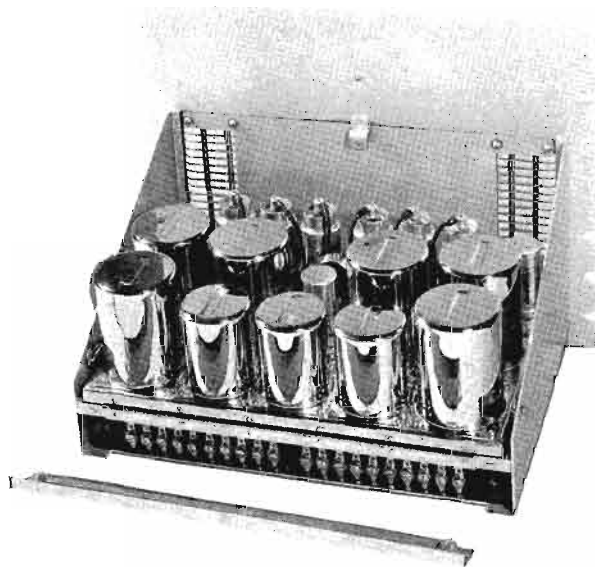

Rear View of 41-C.

DE LUXE PROGRAM AMPLIFIER

Type 40-D . . . A High Performance Unit
Featuring A Vacuum-Tube Volume Indicator

THE TYPE 40-D Amplifier is a highly-perfected equipment which combines the functions of main amplifier and volume indicator. Thus it includes a three-stage low-distortion amplifier having a relatively high output and, in addition, a three-tube volume indicator of special and unique characteristics.

The program or studio amplifier is properly the heart of the speech input channel. Where failure of other units will only handicap the speech system, the failure of the studio amplifier requires shut down or substitution of another amplifier. In the Type 40-D Amplifier proven circuits and circuit components have been utilized to insure utmost reliability. The first stage uses an RCA-1603 "low-noise" tube, pentode-connected; the second stage, an RCA-1603, triode-connected; and the final stage, a pair of RCA-89's push-pull. The use of three stages makes possible an overall gain of 75 db. (equal to the combined gain of the line and monitoring amplifiers of some systems)—thereby providing a margin which gives desirable flexibility and furnishes a means of caring for emergency requirements. A volume control, connected interstage, allows adjustment of gain in 20 steps of 2 db. each.

The V. I. system incorporated in the 40-D Amplifier is unusual, in that it provides a method of reading levels which is at once more easy and more accurate than older methods. The three-tube circuit provides a "floating" indication similar to that of the FCC-approved modulation



Front View of the DeLuxe 40-D Showing RCA's Modern Illuminated Meter Design Which Features Easy Bulb Replacement

monitors. The needle swings up very rapidly, but returns slowly, thus allowing easy reading. Such action gives much the same impression to the eye as do sound levels to the ear. The V. I. circuit may be connected to operate alternatively as a conventional measuring circuit. However, in either case the additional amplifier tubes furnish isolation from the program circuits which is exceedingly desirable. The illuminated V. I. Meter provides readings throughout a range of -20 db. to $+18$ db.

Performance characteristics of the Type 40-D Program Amplifier, like those of the Type 41-C Preamplifier, are exceptionally good. The frequency response is flat from 30 to 17,000 cycles, distortion is less than 0.2% arithmetic sum, and noise level is -60 db. below output level (unweighted). While the normal output level is 0 db., the amplifier will provide a $+18$ db. output without exceeding ordinary distortion limits, thus providing for transmission of a wide dynamic range.

SPECIFICATIONS

Input Impedances: 250/500 ohms. Output Impedances: 250/500 ohms. Overall Gain: 75 db. Normal Output Level: 0* db. Max. Usable Output: $+15$ db. V. I. Range: -20^* db. to $+18^*$ db. Output Noise Level at Normal Output: (55 db. gain) -70^* db. Output Noise Level at Normal Output: (full gain) -60^* db. Distortion: (Arith. Sum) at normal output, 0.2%. Frequency Response: 30—17,000 cycles, ± 1 db. Power Input: 85 watts. Panel Height: $13\frac{3}{32}$ ". Weight: 61 lbs. Tubes: 2 RCA-1603, 2 RCA-89, 1 RCA-25Z5, 1 RCA-6A6, 1 RCA-76, 1 RCA-84. Supplies 180 v. for preamplifiers.

* 0 db = $12\frac{1}{2}$ milliwatts = $+11$ VU



Rear View of 40-D. Substantial Hinges Allow Quick Chassis Opening for Inspection

DE LUXE BRIDGING AMPLIFIER

Type 55-B

The Ultimate in Line Amplifiers



THE RCA 55-B is a bridging or line amplifier useful for isolating a program channel from an outgoing line. Where a single program is fed to several points, such as to a network, a local station and to a short wave transmitter, it is important to prevent any one of the lines from affecting the others. The 55-B has been designed for isolating lines but it is also valuable for other purposes where a gain of 45 db. is required.

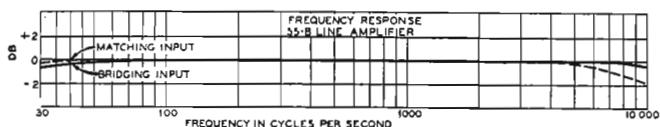

Like other amplifiers of the deluxe line, the 55-B is provided with streamline ventilation louvres and with a hinged chassis to allow for easy access. Pushbutton reading of plate currents is also included. The 55-B is supplied

with a gain control to facilitate setting levels for various lines.

The circuit of the 55-B employs an RCA-1603 in the first stage, driving two RCA-89's in push pull as an output amplifier. Transformer coupling is used throughout. An integral power supply is included using an RCA-80 rectifier. Input terminations provide for bridging or line matching connections and the output is either 500 or 250 ohms. Both hum level and distortion are low and the frequency response is uniform over the range of 30 to 10,000 cycles.

Because the output may be used as high as +20 db., the 55-B may also be employed as a monitor amplifier or as a voltage amplifier to drive individual power amplifiers for loudspeaker operation.

The use of the 55-B insures a reliable, high fidelity amplifier for feeding outgoing programs to lines, and is ideally suited for use at stations feeding more than one outgoing channel.

SPECIFICATIONS

Input Impedances: 500/600 or 20,000 ohms. Output Impedances: 250 or 500/600 ohms. Overall Gain: 47 db. for 600-600 ohms, 30 db. bridging 600 line. Normal Output Level: +11 VU. Maximum Usable Output: +27 VU. Noise Level: -52 VU. Distortion: below 0.3% RMS at normal output level. Frequency Response: 30 to 10,000 cycles with ± 2 db. Power Input: 57 watts, 110 volts, 60 cycles. Panel Height: 10½". Weight: 43 lbs. unpacked. Tubes: 1 RCA-1603, 2 RCA-89, 1 RCA-80.

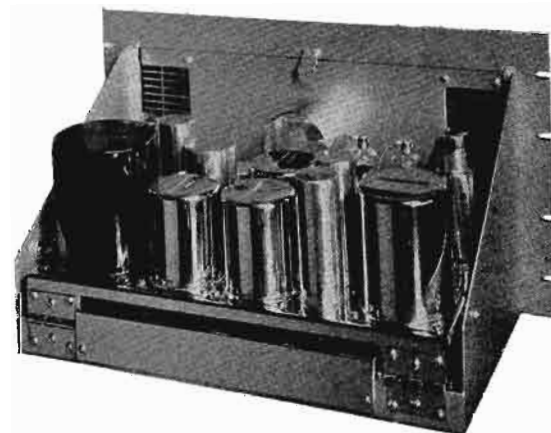
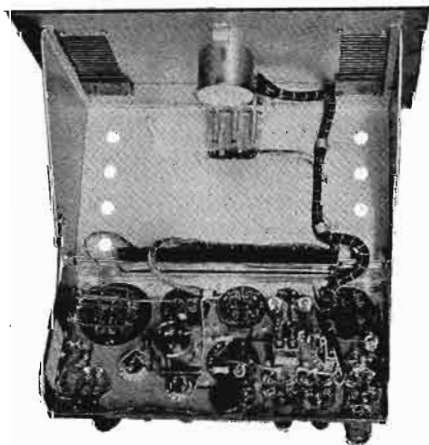

DE LUXE MONITORING AMPLIFIER

Type 94-D

17 Watts with Low Distortion, High Gain

THE RCA Type 94-D Monitoring Amplifier is the newest of the well known RCA 94 series of amplifiers—recognized throughout the radio industry as the ultimate in high quality monitoring equipment. The 94-D features high gain with large, undistorted output, which makes it an unusually flexible amplifier, adaptable to a wide variety of applications. Because it uses the new RCA deluxe mechanical assembly, it is one of the most readily serviced and attractive monitoring amplifiers on the market. Because it utilizes the new beam power tubes in an efficient resistance coupled circuit with degenerative feedback, it is capable of an output power of 17 watts with unusually low distortion content.

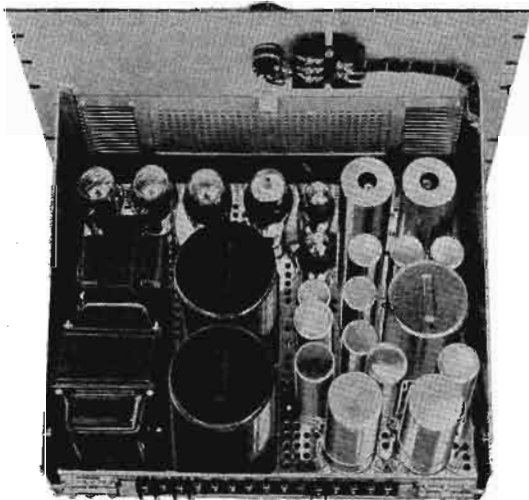
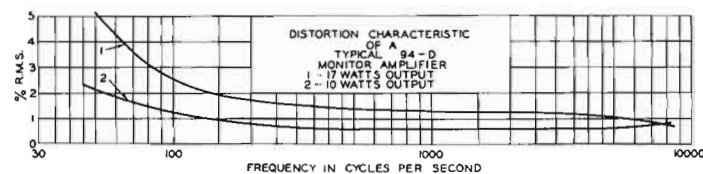
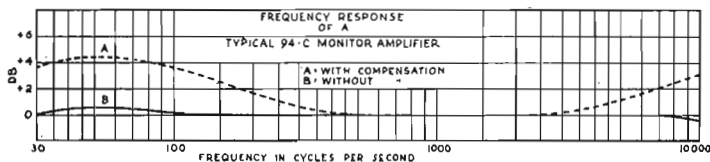
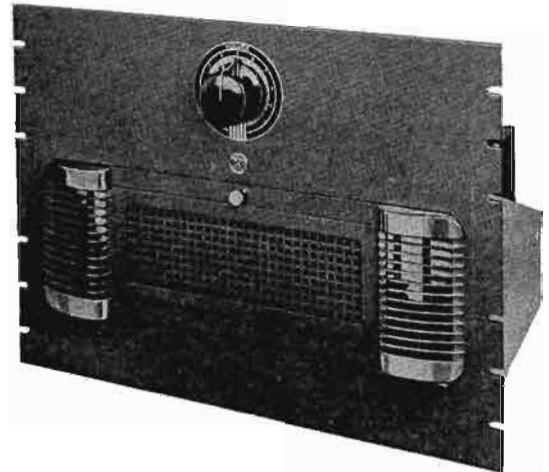

A separate power supply is included in the 94-D for furnishing field current to one or two 56 volt or 110 volt loudspeaker fields. When the speaker field supply is not used, the power input is reduced accordingly and no reactors are required. A compensator circuit gives a 5 db. boost to the low and high frequency ends of the audio band to compensate for the losses normally introduced by the loudspeakers. When the 94-D is used with RCA Type 64-A or UZ-4209 loudspeakers an overall response is obtained which is practically flat over the range of 50 to 12,000 cycles. The compensation may be readily disconnected to provide a flat response if desired.

A bridging type volume control is provided which has an input impedance of 20,000 ohms, an output impedance of 500 ohms and a variation in control of 46 db. This control may, if desired, be mounted externally at a distance from the amplifier.

SPECIFICATIONS

Input Impedance: 20,000 ohms or 500/600 ohms with input control. Output Impedance: 500/600, 15, 7.5, 5 ohms. Overall Gain: 80 db. (600-600 ohms) 48 db. (20,000-600 ohms), 42 db. (bridging with remote gain control). Maximum Output Level: 17 Watts. Noise Level: -24 to -28 VU. Distortion: Less than 3% RMS at 17 watts output for any frequency between 100 and 7,000 cycles. Frequency Response: Rising 5 db. at 50 and 14,000 cycles. Power Input: 100 to 130 volts, 50 to 60 cycles, 150 watts without field supply. Panel Height: 14 inches. Weight: 72 lbs. Tubes: 4 RCA-1603, 2 RCA-6L6G, and 2 RCA-5Z3. (Only one 5Z3 required if speaker field supply is not used.)

THE DELUXE LINE

TYPE 96-A LIMITING AMPLIFIER

*Provides High Compression Capabilities
With Low Distortion and Uniform
Frequency Response*

THE TYPE 96-A Limiting Amplifier is, as its name implies, an amplifier which incorporates an automatic control for limiting the output to some predetermined level. When used with a broadcast transmitter, the average level of the program can be increased several db. without having the peaks overmodulate the transmitter and cause serious distortion and adjacent channel interference. The 96-A operates as a linear amplifier over its normal range but contains an audio compression circuit which starts functioning at a certain level and compresses each additional 10 db. increase of input to an output increase of approximately 1 db.

The RCA 96-A Limiting Amplifier contains many features not found in other similar equipment. The audio compression circuit consists of a biased, linear full-wave rectifier whose d-c output is used as the bias voltage for a variable-gain push-pull amplifying stage. The rectifier is driven by a single stage amplifier whose input is coupled to the output of the variable-gain stage. The variable-gain stage is also transformer coupled to a resistance push-pull stage, which in turn drives two RCA-89 tubes in the push-pull power-output stage. The circuit is straightforward and not unusual, but its application has been made in this case with painstaking design considerations regarding the values of the component parts.

The unit introduces practically no distortion even with large amounts of compression—a matter of importance since a limiting amplifier's primary purpose is to prevent transmitter distortion, and therefore it should introduce negligible distortion itself. The 96-A has been designed with compression timing constants which insure the highest fidelity, maintain a flat frequency response with compression, and prevent distortion of low-frequency audio tones. Complete metering (push button control) is provided for plate currents and the plate voltage. The power supply is regulated to provide a constant output voltage and therefore a constant "point of compression" regardless of varia-



tions in the a-c line voltage. The front panel illuminated meter is connected to a 3-position switch so it may be used for (1) indicating plate currents, (2) indicating "db" of compression, or (3) indicating audio output level in db.

A switch is provided on the chassis inside the front panel door, for making the limiter function inoperative, to facilitate set-up and checking operations. Additional controls on the chassis are a hum balance adjustment, zero adjustment for "db-compression" scale on meter, vernier adjustment of level at which limiting action takes place and a switch for checking the dynamic balance of the push-pull input tubes. Controls regulating the input and output levels are calibrated directly in decibels to facilitate setting.

SPECIFICATIONS

Output Power: +18 db. (0.8 watt) maximum —0.5% RMS 400 cycle distortion; 0 db. (0.0125 watt) normal —0.2% RMS 400 cycle distortion. Input Level: 0 db. maximum without compression; +20 db. maximum with 18 db. of compression; —40 db. minimum level at which compression can be started. Impedance: 500 ohms, input and output. Gain: 58 db. at maximum volume control settings and signal below compression level. Frequency Response: ± 1 db. from 30 to 10,000 cycles with or without compression and at any setting of gain controls. Distortion: Less than 2% RMS at any frequency between 50 and 7000 cycles, at any amount of compression below 18 db. and at any output level below ± 18 db. (0.8 watts). NOTE: The 400 cycle RMS distortion is below 0.5%. Noise Level: 68 db. below zero level, with output control at maximum (86 db. below +18 db. output); —85 db. below zero level, with output control at minimum (75 db. below —10 db. output). Compression Timing: .001 sec. for complete action of gain reducing function. 7 sec. for 90% recovery of gain after signal drops below compression level. Power Input: 105-125 volts, 50-60 cycles, 98 watts at 92% power factor. Output of Power Supply: 260 volts, .075 amps. Tubes: Amplifier: 2 RCA-6K7, 1 RCA-6N7, 2 RCA-89, 1 RCA-6R7; Power Supply: 1 RCA 5U4G, 1 RCA-2A3, 1 RCA-6J7C, 1 RCA-874. Weight: Amplifier, 41 lbs., unpacked; Power Supply, 49 lbs., unpacked. Overall Dimensions: Amplifier—19" wide x 14" high x 9" deep; Power supply—19" wide x 10½" high x 9" deep. Finish: Panels — Rubber black lacquer; Chassis, Reactors, etc. — Polished chromium; Power Transformer—Black Japan. NOTE: Stock number of power supply unit, MI-11300.

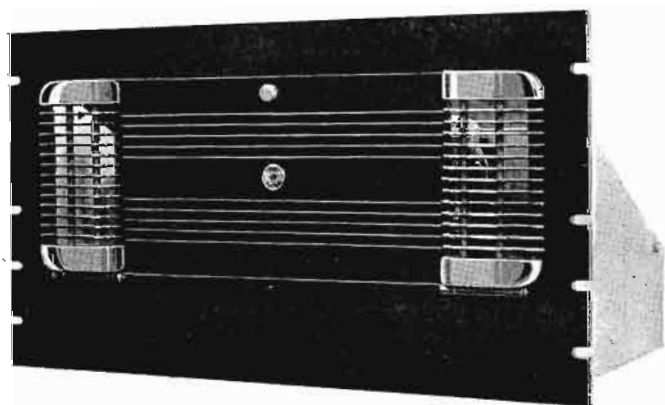

Power Supply Unit of the 96-A

THE DE LUXE LINE

MIXER AND SWITCHING PANEL

Type 46-B . . . A Streamlined Unit Providing Four Mixing Channels Plus Line-Microphone Switching Positions

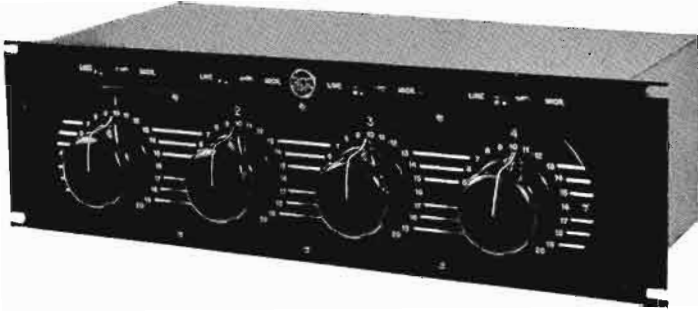

THE TYPE 46-B Panel furnishes all the necessary mixing and switching facilities for the control room of a small station or the control booth of larger stations. The four mixer positions provided will take care of a total of eight input positions, through use of the three-position key-switches in the input of each mixer. These eight sets of input connections allow a number of microphone inputs, transcription turntables and incoming lines to be arranged as desired. For instance, three mixers may connect to microphone inputs in the left position and to in-

coming lines in the right position while the fourth mixer is connected to two transcription turntables. Thus connected, this unit works in very nicely with the Type 41-C Preamplifier, or equally well with separate preamplifiers such as the Type 41-B.

The circuits of the Type 46-B Mixer and Switching Panel are so arranged that the attenuation introduced in each channel is entirely independent of that in the others, while each input is provided with a shorting resistor so that in the center key position the channel is dead. The individual mixers are of the balanced variable ladder type and are of an improved design developed especially for use in this unit. They have twenty contacts providing a total of 38 db. attenuation with infinite attenuation on the last tap.

SPECIFICATIONS

No. of Mixing Positions: four. No. of Input Positions: eight. Input Impedance: 250 ohms. Output Impedance: 250/500 ohms. Fixed Attenuation: 12 db. Variable Attenuation: (2 db. steps) 38 db. Height of Panel: $5\frac{7}{32}$ ". Weight: 20 lbs.

ILLUMINATED METER PANEL

Type 15-C . . . A New Unit Especially Designed for Use with A-C Operated Equipment

WHILE a meter panel is not an absolute necessity, the need for frequent checking of voltages and tube currents is such that one such panel is ordinarily incorporated in each speech input channel. The Type 15-C Meter Panel has been especially designed for use with RCA Deluxe Speech Input Units and to work most efficiently with these. These units do not require patch cords for checking voltages and currents. This improvement in appearance and operation has been obtained by providing push-buttons on these panels which automatically connect the proper meter in the circuit. The Type 15-C is particularly suited to this use. It contains three meters; one for measuring the a-c line voltage; another for measuring plate voltages; and a third for measuring plate currents. The plate voltmeter has a three-position switch associated with it, so that two plate voltage sources may be permanently connected, the third position being off. The milliammeter has a push-button providing two current ranges. When this

meter panel is used with the deluxe units, routine checking is easily accomplished and in case of tube failure the defective unit can be located almost immediately.

SPECIFICATIONS

D-C Voltmeter: 0-250 volts. D-C Milliammeter: 0-10 and 0-100 ma. A-C Voltmeter: 0-150 volts. Dimensions: 19" wide, $5\frac{1}{4}$ " high, 4" deep. Weight: (unpacked) $9\frac{1}{2}$ lbs.

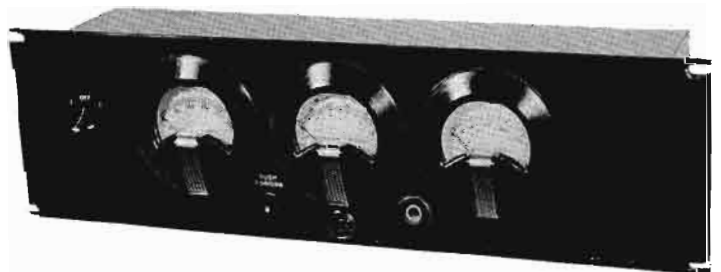



STANDARD LINE SPEECH INPUT EQUIPMENT

THE RCA Standard Line equipment features full size rack mounting units heavily constructed and designed for discriminating users. This equipment is constructed in the conventional rack mounting manner—panel and chassis mounted permanently together with tubes accessible through a door in the front. High fidelity operation is, of course, provided with low distortion and noise level. Components are selected for reliability and long life. The standard line units are distinctly high quality broadcast equipment, pleasing in appearance and convenient to use.

Included in the standard line are such panels as the 41-B pre-amplifier and the 40-C line amplifier which have been used extensively by many stations and which have won an excellent reputation. The 41-B single pre-amplifier forms a convenient unit for adding one additional microphone to a speech input system. The 40-C, with its volume indicator included, offers means for adding another channel at minimum expense.

Thus the standard line of equipment provides flexible units for broadcast service, either in new installations or in expanding of existing facilities, with assurance of high fidelity service and reliable operation.

THE STANDARD LINE

STANDARD PRE-AMPLIFIER Type 41-B

A Single Channel Pre-Amplifying Unit for High Quality Microphones

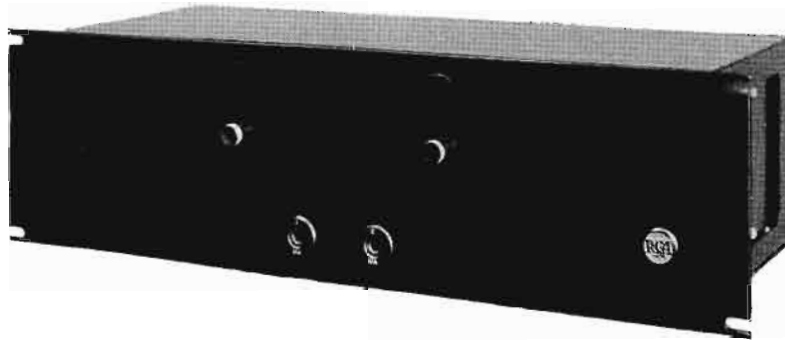

THE TYPE 41-B Pre-amplifier is the standard two-stage single-channel amplifier used in RCA speech systems for several years past. Occupying a position between the 41-C Pre-amplifier of the de luxe line and the 85-A Pre-amplifier of the economy line, it meets the requirements of a number of special applications—not only as a replacement item, but in many new installations; for instance, in de luxe systems where more channels are required than are provided by the 41-C. Or again, where only one or two channels are required, as in agency auditioning setups, or the like. For such uses it provides reproduction quality unexcelled throughout the usable band (30-10,000 cycles), maximum reliability, conveniences such as front access to tubes, and an appearance which allows it to be used with standard, de luxe or economy type installations.

Because of the extremely low signals handled by pre-

amplifiers, microphonics and hum background must be exceptionally low. The Type 41-B Pre-amplifier is designed to meet these requirements. The input circuits are heavily shielded to prevent noise pickup—while the RCA-1603 Radiotrons used in both stages of the amplifier are exceptionally free from microphonics and hum. Standard input and output impedances are used, so that the amplifier may be used with any type of microphone where a fixed gain of about 40 db. is required. The output as normally used is -27 db., but may be as high as +3 db. without causing distortion to exceed ordinary limits. Filament power is obtained from a separately mounted transformer which is furnished. The required plate supply (5 ma. at 180 volts) is ordinarily obtained from a tap on the rectifier of the Type 40-C Amplifier.

SPECIFICATIONS

No. of Channels: one. Input Impedances: 67.5/250 ohms. Output Impedance: 250/500 ohms. Gain: 42/48 db. Normal Output Level: -16 VU. Max. Usable Output: 0 VU. Output Noise Level: -77 VU. Distortion (Arith. Sum): at normal output .4 of 1%. Frequency Response: 30 to 10,000 cycles. Power Required: 6.3 volts, 0.6 amp.; 180 volts, .004 amp. Panel Height: 5 1/4". Tubes: 2 RCA-1603.

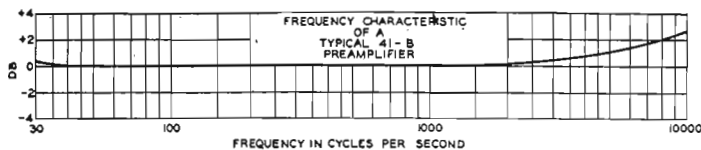

Type 15-B STANDARD METER PANEL

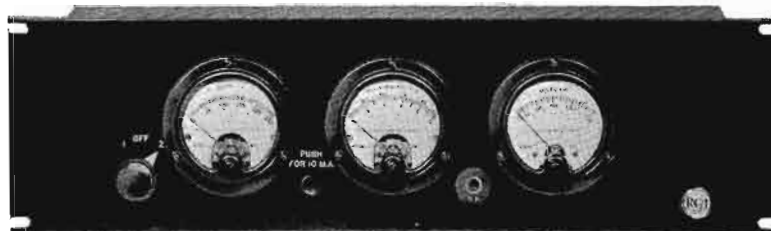

THE 15-B Meter Panel has been especially designed for use with the RCA Standard Line of speech input units. A patch cord is furnished with the 15-B for taking plate current readings and a two-way switch is provided for measuring the plate voltage from two sources. The A.C. meter is permanently connected in the circuit. The milliammeter has a push-button providing two current ranges. When this meter panel is used with the 40-C and 41-B amplifiers, routine checking is easily accomplished, and in

case of tube failure the defective unit can be located almost immediately.

SPECIFICATIONS

D.C. Voltmeter.....0-250 Volts
 D.C. Milliammeter.....0-10 and 0-100 MA.
 A.C. Voltmeter.....0-150 Volts
 Dimensions.....19" wide, 5 1/4" high, 4" deep
 Weight (unpacked).....9 lbs.

THE STANDARD LINE

STANDARD PROGRAM AMPLIFIER

Type 40-C

A Time Tested Unit of Proved Performance and Reliability

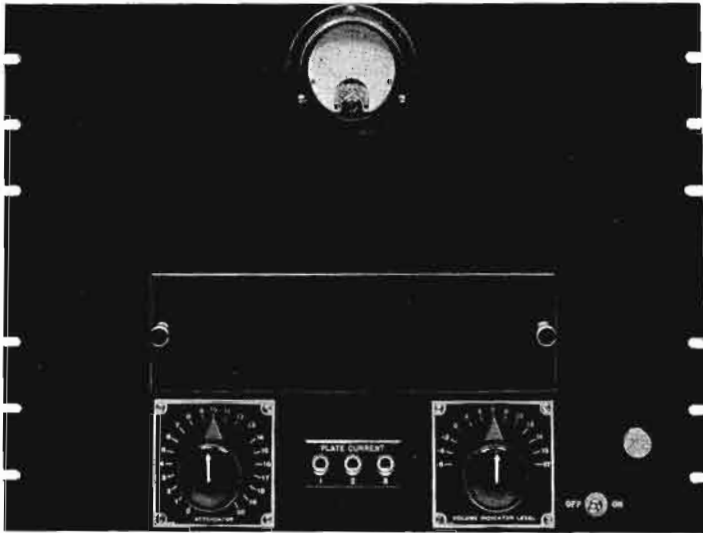

THE TYPE 40-C Program Amplifier is an all-purpose unit which, like the Type 41-B Preamplifier, has proved its worth in hundreds of stations from coast to coast. For use as a replacement in, or addition to, standard type speech systems, it is unexcelled. It has characteristics bettered only by the deluxe Type 40-D Amplifier and like the latter, it includes a built-in V. I. system (rectox type) and a power unit with connections for sup-

plying plate voltages to preamplifiers. While it does not have the deluxe construction, the mechanical design follows time tested lines proven reliability and convenience.

The amplifier proper includes three stages, triode connected RCA-1603's in the first two stages and RCA 89's push-pull in the output stage. This line-up provides an overall gain of 69 db. and while the normal output is of the order of zero db., the amplifier can furnish an undistorted output of +16 db.* The gain control provides 38 db. attenuation in steps of 2 db. The volume indicator—of the copper-oxide type—is of the standard type calibrated from -6 to +18 db.

The rectifier uses an RCA-25Z5 in a voltage-doubler circuit, thus eliminating the usual plate transformer and reducing the likelihood of hum introduction. Besides providing plate voltage for the Type 40-C Amplifier itself, this rectifier also has taps supplying plate voltage for up to three Type 41-B Preamplifiers with suitable plate filter circuits.

SPECIFICATIONS

Input Impedance: 250/500 ohms. Output Impedance: 500/600 ohms. Overall Gain: 69 db. Normal Output Level: 0 db.* Max. Usable Output: +15 db.* V. I. Range: -8 db.* to +20 db. Output Noise Level: -60 db.* Distortion (Arith. Sum): 0.25% at normal output 0 db.* Frequency Response: 30 to 10,000 cycles. Power Input: 75 watts. Panel Height: 13³/₈". Weight: 58 lbs. Tubes: 2 RCA-1603, 2 RCA-89, 1 RCA-25Z5.

* 0 db. = 12¹/₂ milliwatts = +11 VU.

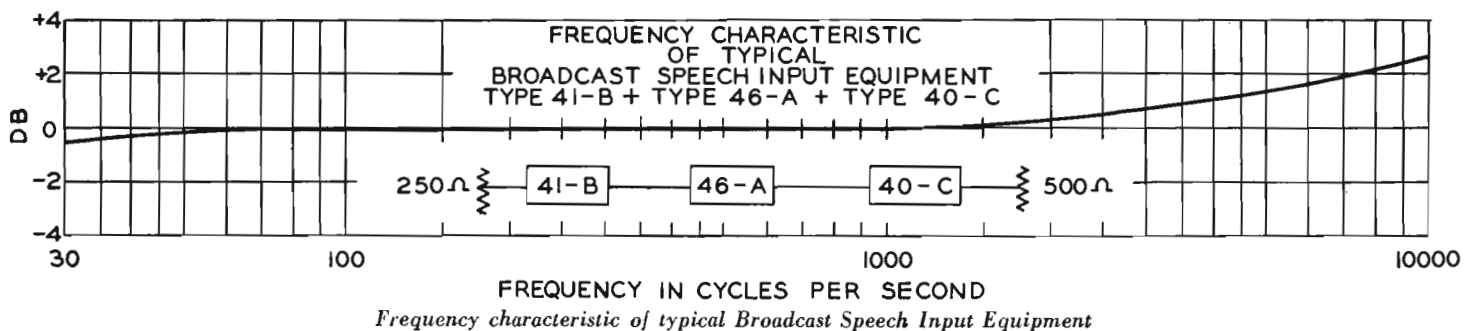
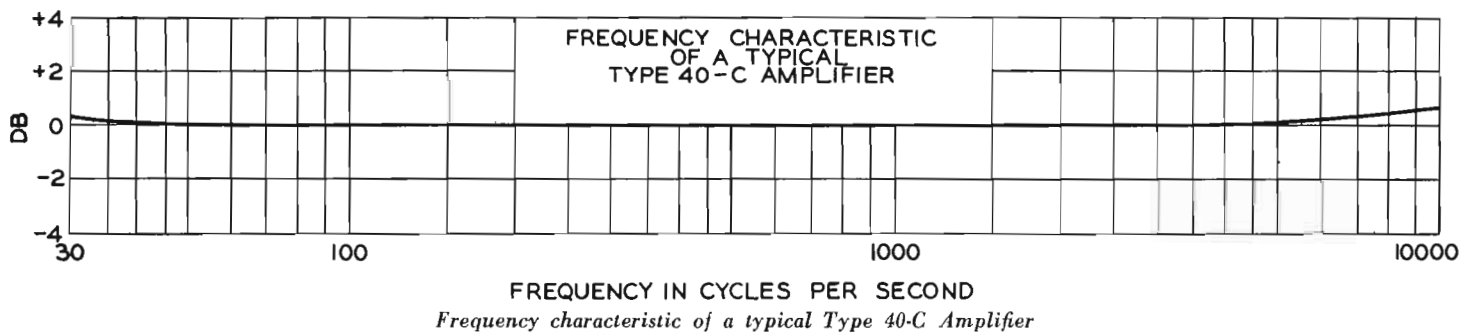



ECONOMY LINE SPEECH INPUT EQUIPMENT

THE "Economy" line has been developed for installations where cost is an important factor but where high quality and fidelity must be maintained. It consists of a complete set of amplifiers for any size of studio installation. The low price of these units is in no way a reflection upon their reliability and operating performance but is the result of careful engineering design. The latest circuit developments, utilizing the best tubes available, have been employed.

Costs have been held to a minimum by omitting deluxe features and by using a simple mechanical design. An installation using RCA "Economy" line units benefits economically because of the low initial cost and because more units can be mounted in less space than with regular speech input equipment. An example of installation possibilities of these units is demonstrated by the Type 80-A Studio Desk shown on the following two pages. The units employ a chassis type construction and are carried in stock without panel mountings. For rack mounting, either the 36-A or 36-B Panel and Shelf Assemblies should be used.

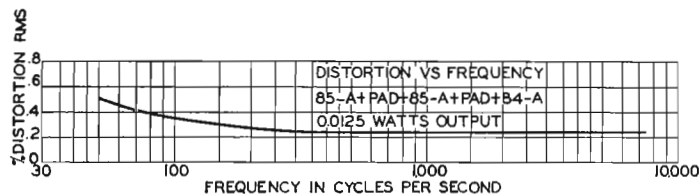

Distortion Curve of Program Circuit

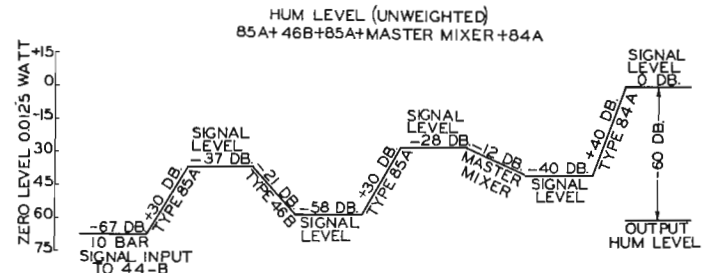
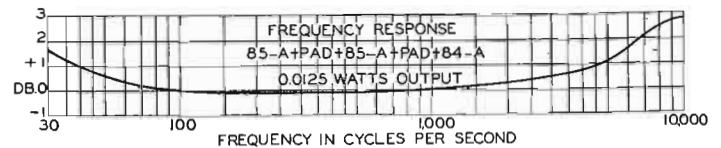

Signal Levels for Studio System
NOTE: 0 db = 12½ milliwatts = +11 VU

The fidelity characteristics of the RCA "Economy" amplifiers are shown in the adjoining curves which represent actual measurements on speech input systems employing units of the "Economy" line. It should be noted that an essentially flat frequency characteristic is obtained from 30 to 10,000 cycles and that the low distortion given in the component amplifier specifications is not just a 400 cycle measurement but for the entire audio band between 50 and 7000 cycles. Also the noise specifications include all unweighted noise components in the output and not only the A. C. hum.

THE ECONOMY LINE

MICROPHONE PRE-AMPLIFIER TYPE 85-A

THE TYPE 85-A Preamplifier is an extremely small, single-tube, high-fidelity microphone pre-amplifier. It has been designed to obtain the maximum gain from the especially developed RCA 1603 tube. Its compact size and low price adapts it to many uses, such as a transcription turntable booster or a booster on the input of the monitoring amplifier to adapt it to low level audition work. Because of the small size and neat mechanical design, considerable flexibility is possible with regard to the installation, since these preamplifiers may be mounted directly in the control console or control desk and thereby eliminate many long leads. The mounting flexibility also applies to rack and panel installations where one to six 85-A's may be mounted on a single 36A or 36B panel. An additional 85-A is usually used as a "booster" amplifier preceding the "master" mixer to provide for low noise to signal ratio. Employing such a system a five channel, high-level mixing, speech input system can be economically installed by using six (one as master booster) 85-A preamplifiers all of which could be mounted on one panel.

The audio transformers for the 85-A Preamplifier were especially developed and designed by RCA Engineers for this application. They feature small size without sacrifice of important operating characteristics and reliability. A recently developed type of shielding cover surrounds the transformer to prevent hum pickup. The tube in the 85-A mounts vertically and is properly shock mounted to prevent microphonics. A filament transformer (MI-11,606) is furnished separately and is capable of furnishing fila-

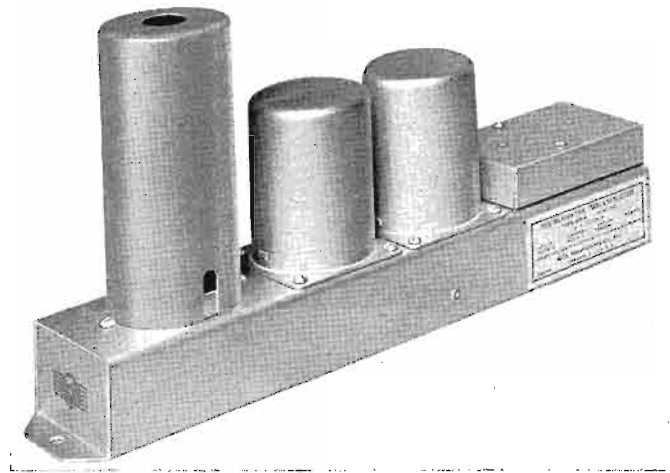

ment power to six 85-A Preamplifiers. Plate voltage is usually obtained from the program amplifier (84-A) but if none is available the RCA MI-11302 or MI-4303 Power Supply is recommended.

SPECIFICATIONS

Input Impedance: 30 and 250 ohms. Output Impedance: 250 ohms balanced and 62.5 ohms unbalanced. Maximum Input Level: -30 VU. Output Level: -0 VU. with 1% RMS distortion. Transmission Gain: 30 db. Frequency Response: ± 1 db. from 100 to 6000 cycles and ± 2 db. from 30 to 100 cycles and 6000 to 10,000 cycles. Distortion: 0.3% at normal output. Noise Level: -92 VU. Tube Complement: 1 RCA 1603. Power Supply: 180 to 250 volts DC at 3 MA for plate, and 6.3 volts AC or DC at .3 Amp. for filament. Weight: 4 lbs. (unpacked). Dimensions: (over all) $2\frac{1}{2}$ " wide x $12\frac{1}{2}$ " deep x 6" high. Finish: Silver grey opalescent.

NOTE: For rack mounting use 36-A or 36-B Panel and Shelves.

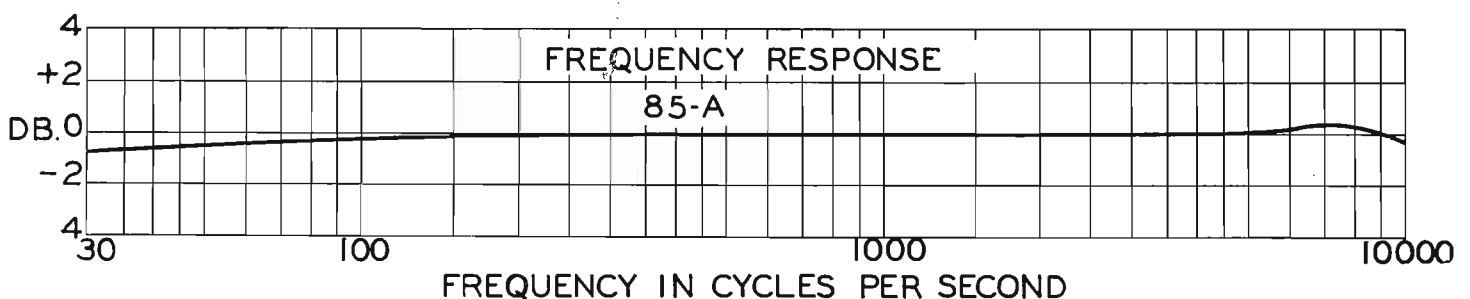

THE ECONOMY LINE

ISOLATION AMPLIFIER TYPE 85-X

The Type 85-X Isolation Amplifier is a single stage unit which has been designed for use in audio circuits requiring an isolation device. When used to bridge program circuits its output may be fed into monitoring busses so that the loudspeaker amplifiers may be switched between the various monitoring circuits without clicks feeding back into the program. The 85-X is ideally suited to such an application because of its low price, small size, flat frequency response and low distortion. Six 85-X's may be mounted on one 36-A or 36-B panel. When bridging a 600 line and working into a 600 monitoring buss, it performs as a no-gain no-loss device with a backward attenuation or isolation of 60 db. The volume control is in reality a feedback control, less than normal feedback increases the gain while greater than normal feedback (16 db.) decreases the gain. When the amplifier is connected for bridging input, the volume control will vary the gain from -3.5 db. to +4 db. through a normal setting of 0 db. With matching input, the gain may be varied from 12 db. to 20.5 db. Thus the maximum possible feedback consistent with the required gain is always utilized.

The power input requirements can be furnished from the MI-4303 or MI-11302 power supplies and the RT-386 (MI-11606) Filament transformer.

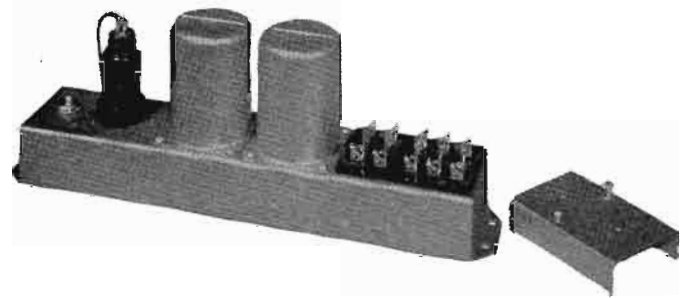

SPECIFICATIONS

Input Impedance.....	600 and 20,000 ohms
Load Impedance.....	600 ohms
Input Level.....	+19 VU, max. bridging
Output Level.....	+19 VU, normal
Distortion.....	Less than 1% at rated output for any frequency between 50 and 10,000 cycles
Frequency Response.....	± 0.5 db. from 30 to 10,000 cycles
Noise Level.....	-75 VU
Gain.....	0 db. bridging, 16 db. matching
Tube Complement.....	1 RCA-1620 (or 6J7)
Power Supply.....	Plate, 180-250 volts, 3.8 ma. at 240 V. Filament, 6.3 volts A.C. or D.C., 0.3 amperes
Dimensions.....	12 $\frac{1}{2}$ " deep, 2 $\frac{1}{2}$ " wide, 6" high
Weight	4 lbs.

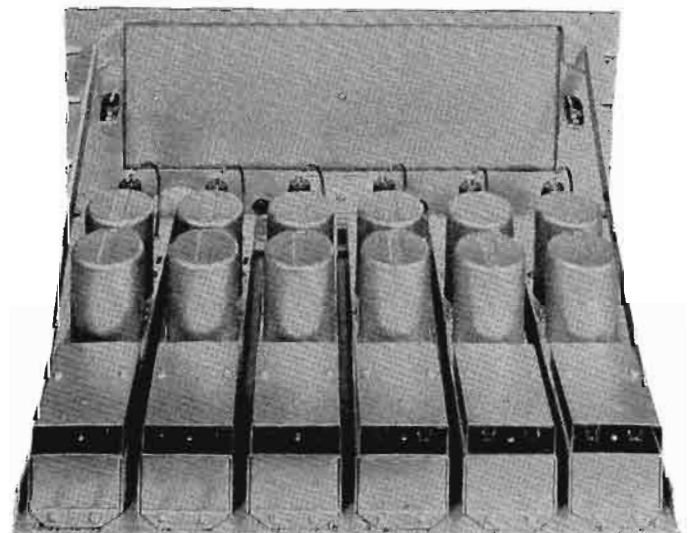
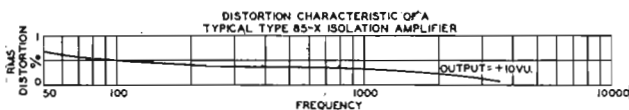
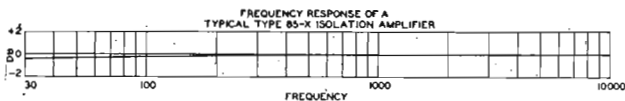

THE ECONOMY LINE

POWER SUPPLIES FOR 85-A AND 85-X AMPLIFIERS

MI-4303

PRE-AMPLIFIER POWER SUPPLY



THE MI-4303 Power Supply is intended to furnish plate and filament voltages for a maximum of two Type 85-A Preamplifiers or 85-X Isolation Amplifiers or one 41-B Preamplifier. It contains a hum control potentiometer across the filament supply. A power switch and a $\frac{1}{2}$ ampere glass fuse is provided. Three MI-4303 power supplies may be mounted on one 36-A or 36-B Panel.

SPECIFICATIONS

Output: (a) 1.5 amperes at 6.4 volts, A.C.; (b) 3.5 ma. at 250 volts, D.C.; 6 ma. at 210 volts, D.C. Input: 110 to 120 volts, 50/60 cycles; 21 watts at maximum load. 90% P. F. Hum Level: —166 db. below 250 volts at 3.5 ma.; —152 db. below 210 volts at 6 ma. Tube Complement: One RCA-80. Dimensions (overall): $5\frac{3}{8}$ " wide, $8\frac{1}{2}$ " deep, $6\frac{1}{2}$ " high. Weight: 6 lbs.

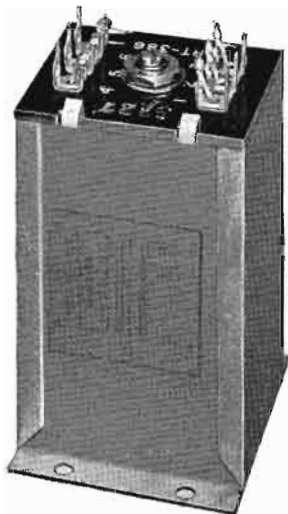

MI-11302

PRE-AMPLIFIER POWER SUPPLY



THE MI-11302 Power Supply has been designed to furnish plate and filament voltages to a maximum of ten Type 85-A Preamplifiers or 85-X Isolation Amplifiers. It will furnish plate voltage to 3 Type 41-C Preamplifiers or 9 Type 41-B Preamplifiers. It contains a hum control potentiometer across the filament supply and an output voltage regulating potentiometer. A power switch and a 1 ampere glass fuse is provided. Two MI-11302 power supplies may be mounted on one 36-A or 36-B Panel.

SPECIFICATIONS

Output: (a) 3 amperes at 6.4 volts, A.C. (b) 50 ma. at 180 to 250 volts, D. C. Note: Output D. C. voltage may be regulated through above limits by means of integral control. Input: 100 to 130 volts A. C., 50/60 cycles. 65 watts for max. load. 90% P. F. Hum Level: Approx. —133 db. below 250 volts at 50 m. a. Approx. —138 db. below 180 volts at 50 ma. Tube Complement: One RCA-5Y3G. Dimensions (overall): 8" wide, $12\frac{1}{2}$ " deep, 8" high. Weight: 18 lbs.

MI-11606 (Type RT-386) FILAMENT TRANSFORMER

THE MI-11606 (Type RT-386) Filament Transformer furnishes filament voltage to a maximum of six 85-A Preamplifiers or 85-X Isolation Amplifiers. It has primary taps for 110 and 120 volts, A. C., 50 or 60 cycles. Its secondary delivers a maximum of 1.8 amperes and 6.3 volts. A variable potentiometer is connected across the secondary and is screw driver operated for obtaining a hum minimum. The overall height is 4" and the overall base dimensions are $2\frac{11}{16}$ " x $2\frac{3}{8}$ ". Four .199" mounting holes are located on $2\frac{5}{16}$ " x $1\frac{1}{4}$ " center lines.

THE ECONOMY LINE

PROGRAM AND LINE AMPLIFIER

Type 84-A

THE TYPE 84-A General Purpose Amplifier has been developed to fill the place in the "Economy" line which has long been occupied in the "Standard" line by the famous RCA 40-C. It includes a number of features which make it one of the most versatile speech-input amplifiers on the market. It consists of an AC operated, three stage amplifier featuring high overall gain with a low noise level. This amplifier has been primarily designed as a Studio or Program Amplifier to boost the output of the preamplifiers or mixtures to a level sufficiently high to feed a line or transmitter. For this purpose its characteristics are ideally suited. It may, however, also be used as a high or low gain bridging amplifier for which case a 20,000 ohm bridging input pad has been provided in addition to the regular 250 and 500 ohm transformer inputs. For conditions where the normally high gain is not required, as in line and isolation applications, a link switch permits connecting around and removing the first tube leaving a two stage amplifier. Because of the conservatively operated output tubes and a 10.5 ohm output impedance tap, the amplifier may be used as an emergency monitoring amplifier under which condition an output of 1.5 watts may be obtained with approximately 3.5% RMS distortion. However, for normal operation where the output does not exceed +27 VU (0.5 watt) the RMS distortion is less than 1%.

The circuit of the 84-A Amplifier employs one RCA-1603 pentode connected as the first stage and one RCA-1603 triode connected as the second stage. Two RCA-89's

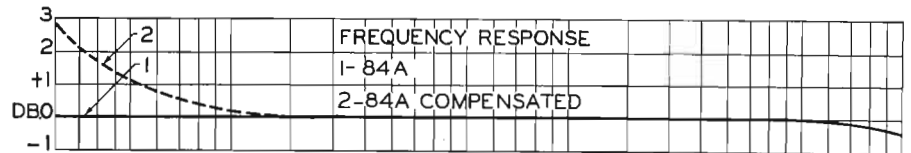

are used in the power output stage. Resistance coupling is used between the first and second stage and transformer coupling between the second and output stages. As supplied, the 84-A has an essentially flat frequency response from 30 to 10,000 cycles. A compensating network is included as a part of the amplifier which, when used, gives the amplifier a 3 db. rise at 30 cycles. This latter characteristic is desirable when the 84-A is employed in a system using preamplifiers which employ small sized input and output transformers. Such preamplifiers usually have a 30 cycle drop of from 1 to 1.5 db. and since they are single stage units two are usually used in cascade thus requiring a 3 db. compensation in the program amplifier.

The volume control and the hum control are located on the front part of the chassis. Terminals and an external meter switch are provided for checking the cathode voltage (plate current indication) of each tube with an external meter. Also located on the chassis are a line switch and a line fuse. Terminals are provided for supplying an additionally filtered plate voltage (215 volts at 16 ma.) for the preamplifiers. This supply is sufficient for six Type 85-A Preamplifiers. One 84-A Amplifier may be mounted on one 36-A or 36-B Panel.

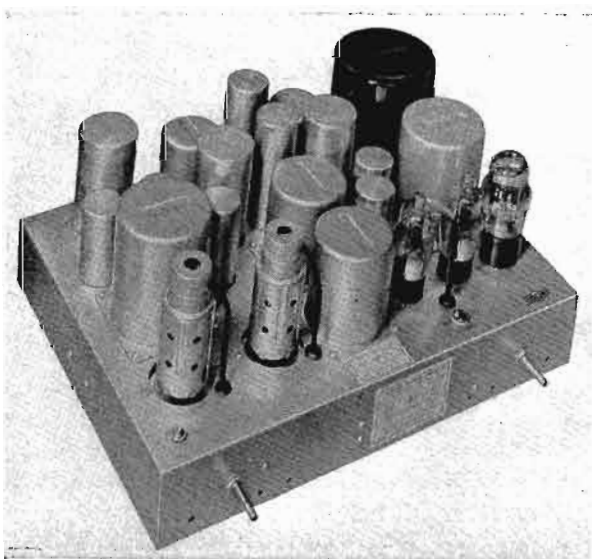

SPECIFICATIONS

Input Impedance: 500/600 and 250 ohms, balanced; 125 and 62.5 ohms, unbalanced; 20,000 ohms, bridging, balanced. Output Impedance: 500/600 and 250 ohms, balanced and 125, 62.5 or 10.5 ohms unbalanced. Output Level: +21 VU with 0.5% RMS distortion, and +27 VU (0.5 watt) with 1% RMS distortion. Overall Gain (Max): 75 db., matching; 37 db., bridging; 50 db., matching but less first tube. Max. Input Level: +27 VU limited only by transformer saturation. Frequency Response: ± 1 db. from 30 to 10,000 cycles. Noise Level: -49 VU unweighted, maximum gain. Power Input: 105 to 125 volts, 50 to 60 cycles, 60 watts at 93% power factor. Tube Complement: 2 RCA-1603, 2 RCA-89, and 1 RCA-80. Weight: 40 lbs. (unpacked). Overall Dimensions: 16" wide x 13" deep x 7 $\frac{3}{8}$ " high. Finish: Silver grey opalescent.

THE ECONOMY LINE MONITORING AMPLIFIER

Type 82-B

THE TYPE 82-B Monitoring Amplifier is a low distortion, AC operated, 8 watt amplifier which may be used with an external volume control. The comparatively high overall gain of the 82-B makes it quite versatile for it may be operated directly from the preamplifiers for audition purposes. Its 500 ohm input and output impedances make it suitable for emergency operation as a program amplifier.

Although its design enables three loudspeakers to be operated very satisfactorily, its low cost permits the broadcast engineer to use individual amplifiers with each of the office and house monitoring loudspeakers. Such a system has proven to be the most satisfactory because it permits dial and direct switching between monitoring channels.



The 82-B Chassis

The inputs of the speaker amplifiers may be bridged across any of the program channels without affecting the volume of other loudspeakers. Such an arrangement allows the monitoring busses to be operated at low levels to prevent cross-talk.

Output impedances of one, two or three loudspeaker voice coils are provided. Field supply (110 volts) for these speakers is furnished by the built-in power supply. When the field excitation is not required the voltage dividing resistor may be disconnected and the power transformer secondary taps changed thus reducing the input power by approximately 40 watts. The volume control is a special unit which may be mounted externally as desired. It consists of a double potentiometer which gives complete control of the volume level and provides a balanced input. Input resistors are so connected that a short in the volume control will not short the line across which it is connected.

The circuit of the 82-B amplifier is straightforward. A triode connected is employed in the first stage. One is used for the second stage and an additional is used as an inverter tube. Two in push-pull constitute the power output stage and careful designing has been used to realize the efficiency possible with these beam-power tubes while maintaining complete stability. Degenerative feed-back is utilized and the feed-back loop is from the secondary of the output transformer to the cathode of the second amplifier tube.

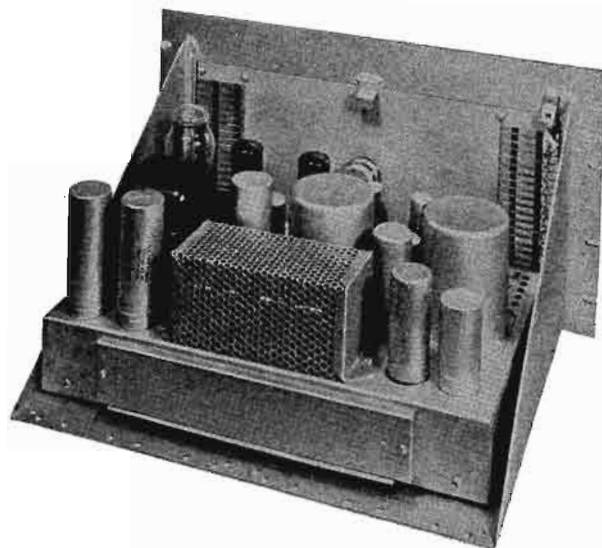

Rear View of 82-B Mounted on 36-A Shelf

By using interstage resistance coupling and by using proper circuit constants, the feed-back has been successfully adapted to operate over a wide band of audio frequencies.

As supplied, the 82-B Monitoring Amplifier has an essentially flat frequency response from 30 to 10,000 cycles. Where it is desirable to peak the high and low frequency ends of the audio band a small compensating network (MI-4313) is available and may be easily installed without drilling. One 82-B amplifier may be mounted on one 36-A or 36-B Panel.

SPECIFICATIONS

Input Impedances: 500 and 20,000 ohms. **Output Impedances:** 500, 15, 7.5 and 5 ohms. **Overall Gain:** 67 db. with matching input, 49 db. with bridging input and 35 db. with bridging input and remote volume control. **Output Level:** 8.0 watts with less than 2% RMS distortion. **Frequency Response:** ± 1.5 db., 30 to 10,000 cycles. **Noise Level:** -29 VU, unweighted. **Power Input:** 115 volts, 60 cycles, 157.5 watts at 90% power factor. **NOTE:** When not supplying speaker fields deduct 40 watts. **Tube Complement:** 3 RCA-1620 (6J7); 2 RCA-1622 (6L6); 1 RCA-5 U4G. **Weight:** 25 lbs. (unpacked). **Overall Dimensions:** 16 inches x 10 inches x 7 inches high. **Finish:** Silver gray opalescent. **Stock Number** **Compensating Network:** MI-4313. A 180 V. (21.5 ma.) tap is available on the terminal board that may be used in conjunction with an MI-11203 external filter as an emergency supply for 85-A Preamplifiers.

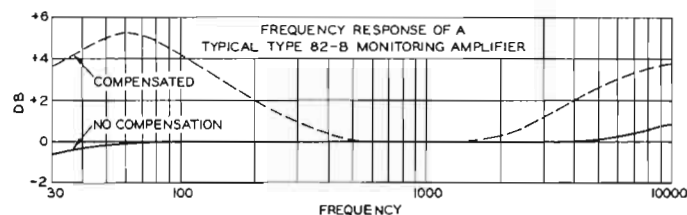

THE ECONOMY LINE PANEL AND SHELF

Type 36-A

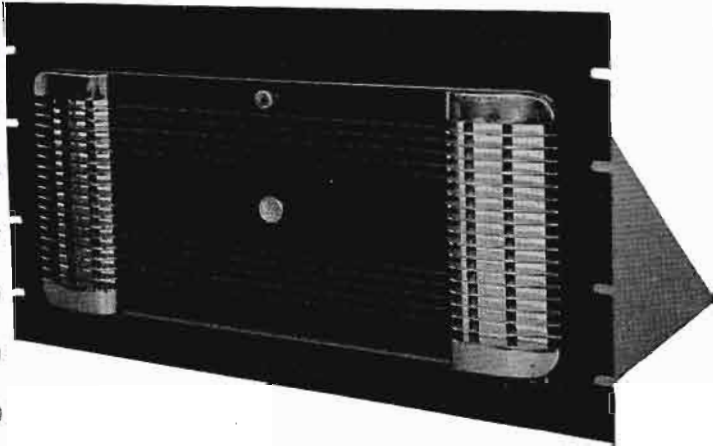

THE TYPE 36-A Panel and Shelf Assembly is designed to mount the various units of the "Economy" line on a standard speech input rack. It can of course be used for rack mounting various other equipment which has suitable dimensions. The 36-A matches the front panel appearance and provides some of the features of the "De Luxe" line of RCA Speech Input Equipment. A plate current switch is not furnished with the 36-A. Ventilation is obtained through the chromium plated louvres which are a part of the door. On the rear of the panel is secured a horizontal shelf on which the amplifier chassis is normally mounted. Such a mounting arrangement allows quick access to tubes and comparatively easy chassis removal for servicing. It also maintains a vertical mounting for all the tubes thereby insuring quieter operation and longer life.

SPECIFICATIONS

Panel Dimensions: 19" wide x 10½" high. Shelf Dimensions: 16⅝" wide x 13" deep. Provides mounting space for:

- 6—85-A Preamplifiers
- 6—85-X Isolation Amplifiers
- 1—84-A Program Amplifier
- 1—82-B Monitoring Amplifier

MI-11700 Plate Current Indicating Meter

The MI-11700 Meter is a 7½ volt Voltmeter mounted in an RCA illuminated streamlined case. The meter is used to measure bias voltages across either the whole or a part of the bias resistor. This serves as an accurate indication of plate current. The meter has an internal resistance of 20,000 ohms per volt and may therefore be switched into the low level tube circuits without interfering with the program. The meter requires a 2¾" diameter round mounting hole and its flange diameter is 3¾". The illuminating lamp requires 6.3 volts. The meter is calibrated to mount on a ⅛" steel panel.

Type 36-B



THE TYPE 36-B Panel and Shelf Assembly is similar to the 36-A except that the door is not hinged and the louvres have been omitted. Thus the 36-B provides a high quality low cost rack mounting for "Economy" line amplifier units. The mounting presents a very neat appearance and offers nearly all the features described for the 36-A. The door of the 36-B has three stripes on each side of the nameplate and holes are provided at the lower right and lower left for volume controls and meter switches. A metering switch is supplied with each shelf and is used for switching a meter for measuring bias voltages of the 83B, 84A and 85A amplifiers, thus providing an indication of plate current.

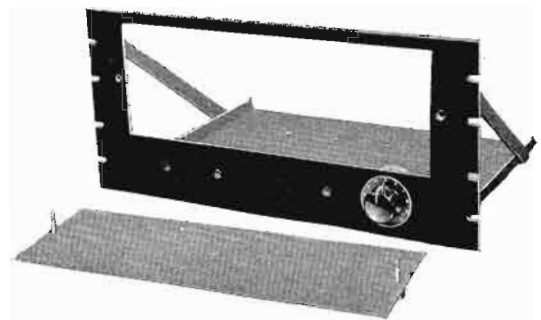

SPECIFICATIONS

Panel Dimensions: 19" wide x 8¾" high. Shelf Dimensions: 16¾" wide x 13" deep. Provides mounting space for:

- 6—85-A Preamplifiers
- 6—85-X Isolation Amplifiers
- 1—84-A Program Amplifier
- 1—82-B Monitoring Amplifier

MI-11701 Meter Transfer Switch

The MI-11701 Switch may be used with the MI-11700 Plate Current Indicating Meter to permit rapid checking of plate currents in any of 6 positions. The switch is furnished with a knob and dial and is single hole (1⅜") mounting.

SUMMARY OF RCA BROADCAST AMPLIFIER CHARACTERISTICS

Type	Usage (Equipment Line)	Max. Gain	Max.* Input	Max.* Output	Input Impedance	Output Impedance	Type Mounting	Cat. Page
85-A	Preamplifier, 1 stage (Economy)	30 db.	-30 VU	0 VU	30, 250 ohms	250, 62.5 ohms	Chassis (or rack)	42
41-B	Preamplifier, 2 stages (Standard)	48 db	-48 VU	0 VU	50, 250 ohms	250, 500 ohms	Rack	39
41-C	Triple Preamplifier, each 2 stages (DeLuxe)	46 db	-48 VU	0 VU	50, 250 ohms	250, 500 ohms	Rack	32
84-A	Program and Line Amplifier (Economy)	75 db matching 42 db bridging	+27 VU	+27 VU	500, 250, 125, 62.5, 20,000 ohms	500, 250, 125, 62.5, 10.5 ohms	Chassis (or rack)	45
40-C	Program Amplifier with V. I. (Standard)	69 db	-5 VU	+26 VU	62.5, 125, 250, 500 ohms	250 ohms 500 ohms	Rack	40
40-D	Program Amplifier with V. I. (DeLuxe)	75 db	-37 VU	+26 VU	62.5, 125, 250, 500 ohms	250, 500 ohms	Rack	33
85-X	Isolation Amplifier (Economy)	0 bridging 16 db matching	+19 VU +3 VU	+19 VU	20,000 ohms 600 ohms	600 ohms	Chassis (or rack)	43
55-B	Isolation and Line Amplifier (DeLuxe)	30 db bridging 47 db matching	+27 VU +18 VU	+27 VU	500, 20,000 ohms	500, 250, 125, 62.5, 10.5 ohms	Rack	34
82-B	Monitor Amplifier (Economy)	67 db matching 49 db bridging 35 db bridging with remote v.c.	+30 VU	8 Watts (with 2% RMS dist. 50-10,000 cycles)	500 ohms 20,000 ohms	500, 15, 7.5, 5 ohms	Chassis (or rack)	46
94-D	Monitor Amplifier (DeLuxe)	77 db matching 45 db bridging 39 db bridging with remote v.c.	-35 VU, matching -19 VU, bridging +30 VU, brdging with remote v.c.	17 Watts (with 3% RMS dist. 100-10,000 cycles)	500, 20,000 ohms	500, 15, 7.5, 5 ohms	Rack	35
96-A	Limiting Amplifier (DeLuxe)	58 db (with no compression)	+11 VU	+29 VU	500 ohms	500 ohms	Rack	36

0 VU = 1 milliwatt across 600 ohms = -11 db with 12½ milliwatt reference.

*Unless otherwise specified Max. Input and Output levels are for 1% RMS distortion at any frequency between 50 and 10,000 cycles.



Speech Input Accessories

SWITCH and FUSE PANEL Type 57-A

*Especially Designed for Use with
A. C. Operated Equipment*



THE TYPE 57-A Switch and Fuse Panel is an auxiliary unit designed for input control of the AC supply. Ordinarily one such panel is used with each rack or channel of speech units. On this panel are mounted and wired a flush-type indicator lamp with red cap, a double fuseblock of the screw-plug type and a double-pole single-throw tumbler switch. In addition there is a subpanel which is drilled to provide a mounting for five of the standard transformers (two isolation and three filament, or one isolation and four filament) used with the various amplifier units. This panel, ordinarily located near the bottom of the rack, thus insures a convenient mounting for these transformers and keeps them well away from the low-level amplifier circuits.

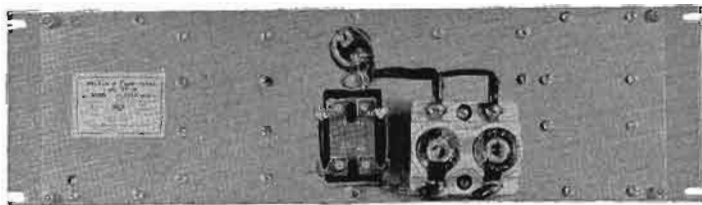

SPECIFICATIONS

General Type: 110 volt, A.C. control. Switch: double-pole, single-throw. Indicator Lamp: 110 volt. No. of Transformer Mountings: five. Dimensions: $5\frac{3}{8}'' \times 19''$.

PATCH CORDS

RCA maintains a stock of patch cords for the convenience of broadcasting stations. These cords are the standard telephone type using two W. E. 241-A Double Plugs and a W. E. cord. Three sizes are available as listed below.

- MI-4652-2 Two foot cord length
- 4652-4 Four foot cord length
- 4652-6 Six foot cord length

JACK PANELS Type 33-A and Type 33-B

Standard Panels for Use with All Equipments

OF THE auxiliary panels designed for use with the basic speech units described on the previous pages, the jack panels are perhaps the most important. By bringing out the input and output connections of the amplifier and mixing units to jacks, the overall flexibility of a speech



33-A Jack Panel



A Rear View of the 33-A Jack Panel



33-B Jack Panel

input system is greatly increased, and testing and servicing facilitated. Type 33-A and 33-B Jack Panels are most convenient for this use. The former consists of one row of twelve double-jacks with designation-card holders—while the latter is similar but has two rows of jacks. The jacks are of the closed-circuit type, so that regular circuits are ordinarily normaled through—and are broken only when a double plug is inserted in order to make an external connection. The jack sleeves are chromium plated.

SPECIFICATIONS

Number of Jacks: 48 in 33-A, 24 in 33-B. Type of Jacks: Double jacks of standard closed-circuit type. Dimensions: of 33-A, $2\frac{1}{8}'' \times 19''$; of 33-B, $1\frac{1}{4}'' \times 19''$.

JACK MATS

JACK MATS are available for covering 1, 2 or 3 Type 33-A Double Jack Strips. When ordering specify finish required.

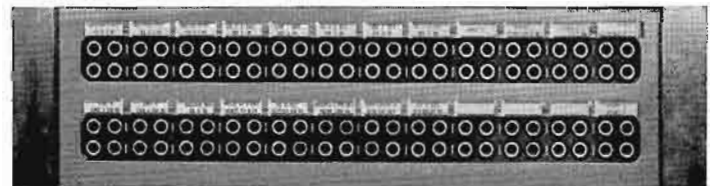

33-A Jack Panels mounted in 78-B1 Rack

SPECIFICATIONS

- MI-11501 Single Jack Strip Mat... Overall Size $19'' \times 3\frac{1}{2}''$
- MI-11502 Double Jack Strip Mat... Overall Size $19'' \times 5\frac{1}{2}''$
- MI-11503 Triple Jack Strip Mat... Overall Size $19'' \times 6\frac{3}{4}''$

STANDARD and CABINET RACKS

Types 9-A, 9-B, 9-C, etc.

A COMPLETE LIST OF SIZES AND ACCESSORIES

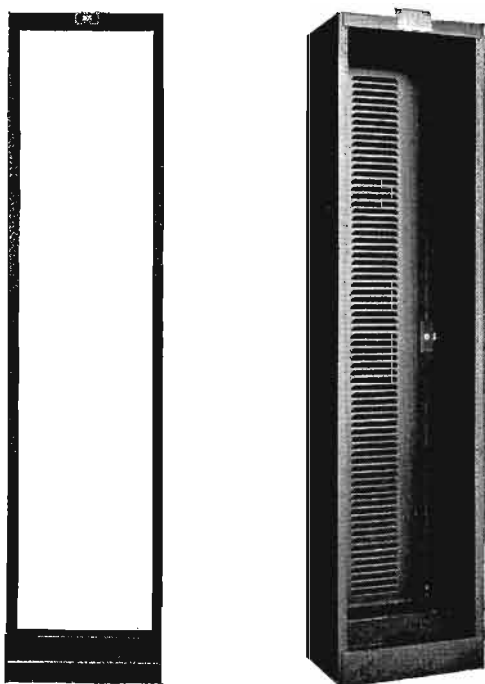

RACKS of standard construction are carried in stock in all standard sizes. However, the Type 9-AX Cabinet Rack (shown at the right) is now more generally used. It provides complete shielding and protection for all of the equipment on the racks, while at the same time largely dispensing with individual shield covers. A large easily-opened rear door provides instant access to all equipment. The rack is drilled for standard panels exactly as are regular racks. A total of 77" of panel space is provided. If desired, cabinet racks, with chromium strips and trim can be supplied. Regular "U" and "J" strips, both for the standard and cabinet racks, are also carried in stock.

SPECIFICATIONS

Type 9-AJX Cabinet Rack (82 $\frac{7}{8}$ " high) with 2" "J" Strips. (See 78C-1, Page 00.)

Type 9-AUX Cabinet Rack (82 $\frac{7}{8}$ " high) with 1 "U" Strip

Type 9-AJZ Cabinet Rack with 4 brushed chromium "J" Strips and trim ("J" strips and trim not attached). (See 78B-1, Page 00.)

Type 9-AUZ Cabinet Rack with brushed chromium "U" strips and trim ("U" strip and trim not attached)

Type 9-A Relay Rack (82 $\frac{7}{8}$ " high) with "U" or "J" strips

Type 9-B Relay Rack (75 $\frac{7}{8}$ " high) with "U" or "J" strips

Type 9-C Relay Rack (68 $\frac{7}{8}$ " high) with "U" or "J" strips
Type 9-D Relay Rack (56 $\frac{7}{8}$ " high) with "U" or "J" strips
MI-4656 Brushed chromium "J" trim for 9AX Rack (4 "J" strips and trim)

MI-4658 Brushed chromium "U" trim for 9AX Rack (1 "U" strip and trim)

Type MI-4524 "U" Strips for 9-AX Cabinet Racks

Type MI-4537 "J" Strips for 9-AX Cabinet Racks

Type MI-4520 "U" Strips for 9-A Rack

Type MI-4521 "U" Strips for 9-B Rack

Type MI-4522 "U" Strips for 9-C Rack

Type MI-4523 "U" Strips for 9-D Rack

Type MI-4511 "J" Strips for 9-A Rack

Type MI-4512 "J" Strips for 9-B Rack

Type MI-4513 "J" Strips for 9-C Rack

Type MI-4514 "J" Strips for 9-D Rack

SHELVES

Types 35-AA, 35-B, 35-C

SHELVES of matching finish and style are carried in stock as standard items. These are drilled ready for assembly on the rack. They require a space 7" high. In addition to the regular designs in various rack widths, there is available a special deluxe design with rounded corners in the single width only. See Page 21.

SPECIFICATIONS

Type 35-AA Shelf...DeLuxe, single width 3 $\frac{1}{2}$ " high

Type 35-B Shelf...Standard, double-width 7" high

Type 35-C Shelf...Standard, triple-width 7" high

BLANK PANELS

Type MI-4589 to MI-4599

STANDARD DULL - BLACK PANELS IN ALL WIDTHS

IN order to provide for filling spaces on the rack not occupied by equipment panels, a complete line of blank panels is carried in stock. These include all standard widths from 1 $\frac{3}{4}$ " to 12 $\frac{1}{4}$ ". They are of $\frac{3}{16}$ " sheet steel and are finished and drilled so that they exactly match the standard equipment panels.

Type MI-4590 Blank Panel (1 $2\frac{3}{32}$ " Width)

Type MI-4598 Blank Panel (2 $\frac{1}{8}$ " Width)

Type MI-4599 Blank Panel (2 $\frac{3}{8}$ " Width)

Type MI-4589 Blank Panel (3 $\frac{3}{32}$ " Width)

Type MI-4591 Blank Panel (3 $1\frac{5}{32}$ " Width)

Type MI-4592 Blank Panel (5 $\frac{7}{32}$ " Width)

Type MI-4593 Blank Panel (6 $3\frac{1}{32}$ " Width)

Type MI-4594 Blank Panel (8 $2\frac{3}{32}$ " Width)

Type MI-4595 Blank Panel (10 $1\frac{5}{32}$ " Width)

Type MI-4596 Blank Panel (12 $7\frac{3}{32}$ " Width)

Type 56-D LINE EQUALIZERS Type 56-B



THE Type 56-D Variable Equalizer provides a desirable means of equalizing high or low grade lines because it provides a maximum of boost of 26 db. at 25, 50 or 100 cycles simultaneously with a maximum boost of 26 db. at 4,000, 6,000, 8,000 or 10,000 cycles. The equalization is variable in steps of 3 db. by means of "bridged-T" pads. The high frequency and low frequency equalizing controls are made independent of each other through the use of a constant impedance circuit. A master variable attenuator permits an overall volume control in 19 steps on 3 db. The panel includes a balanced line transformer with static shielding between windings and with a highly efficient outside shielding to eliminate hum pickup. A dust cover is included.

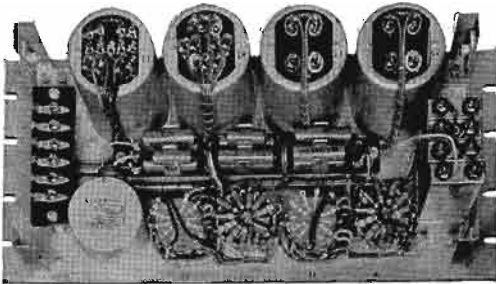

SPECIFICATIONS

Input Impedance: 600 ohms, balanced. Output Impedance: 600 ohms, unbalanced. Input Level: +11 VU. Output Level: +11 VU. Insertion Loss: 0.6 db. Maximum Loss: 27 db. low frequency equalization; 27 db. high frequency equalization; 54 db. low and high frequency equalization. Noise Level: -100 VU. Panel Height: 8 $\frac{3}{4}$ ". Weight: 24 lbs.

Type 56-E



THE RCA Type 56-E Line Equalizer has been designed to equalize the non linear characteristics of either one or two telephone lines, and it consists of two separate and complete variable equalizers mounted on a single panel. Any amount of equalization from zero to 40 db. may be obtained in steps of approximately 3 db. The 56-E does not include line transformers or master attenuators.

SPECIFICATIONS

Source Impedance: 500/600 ohms. Insertion Loss: 7 db. minimum. Mounting: May be rack mounted on any standard rack or on an MI-11500 wall-mounting cabinet. Size: 19" wide, 4 $\frac{3}{4}$ " deep, 3 $\frac{1}{2}$ " high. Weight: 7 lbs.

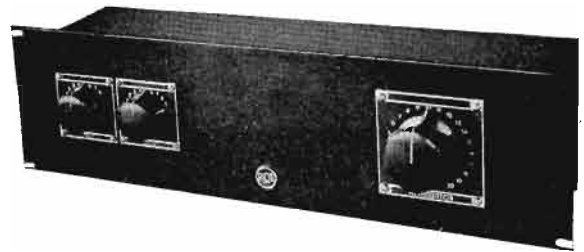

ONE of the four line equalizing units for use with RCA transmitter installations, the RCA 56-B is a rack mounting panel equipped with a variable ladder type pad in the output for controlling gain and with the network resistors variable from the panel. A repeat coil is included. This unit is desirable where equalization is likely to be varied or where one equalizer is not tied up permanently with a line.

SPECIFICATIONS

56-B—Input and Output Impedance: 500 ohms. Attenuation: 20 to 50 db. Volume Control Range: 38 db. in 2 db. steps. Resistors: 100 ohms in 10 ohm steps and 10 ohms in 1 ohm steps. Repeat Coil: 1-1 ratio. Dimensions: 19" length, 5 $\frac{1}{4}$ " height, 8 $\frac{1}{2}$ " depth. Weight 20 lb. unpacked.

Type 56-C

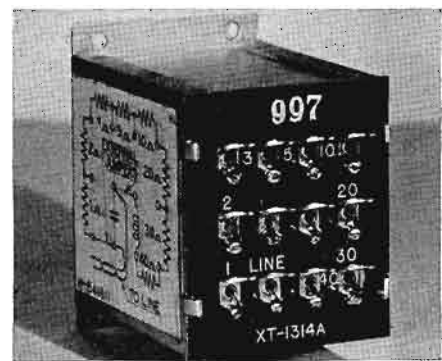

THE 56-C equalizer is a semi-fixed unit, mounted in a metal case to reduce the space requirements so that a number may be located on the rear of one blank panel. Similar in appearance to a transformer, the resistance terminals are brought out to soldering lugs on the top of the case, where they may be shorted out until the correct equalization is obtained. The 56-C is particularly useful in connection with permanent lines.

SPECIFICATIONS

56-C—Input and Output Impedance: 500 ohms, approx. Attenuation: 1 to 30 db. Resistors: Tapped, semi-fixed, 1-111 ohms. No repeat coil. Dimensions: 3 $\frac{5}{8}$ " length, 3 $\frac{3}{4}$ " height, 2 $\frac{1}{2}$ " depth. Weight 2 lbs. unpacked.

TERMINAL TRANSFORMERS

RCA offers several transformers for interconnection between speech input units which will be useful to the broadcasting station. These transformers are used in RCA amplifiers and are of the highest quality design and manufacture. When used for the purposes for which they are recommended, the frequency response will be uniform from 30 to 10,000 cycles. The several transformers are provided with electrostatic shields between primary and secondary and are furnished with heavily shielded cases. Cores are of special high permeability steel. Terminals are at the top and diagrams of the connections are stenciled on the side of the case. Broadcasting stations may employ the RCA terminal transformers between units with assurance that the overall fidelity of the system will be maintained.

Dimensions of all cases—3 1/2" dia., 4 3/8" height overall. Baseplate 3 3/4" x 3 3/4". Mounting hole center lines are 2.437" x 2.437".

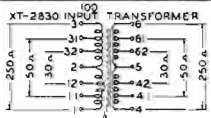
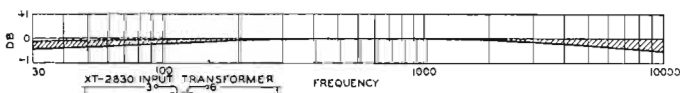
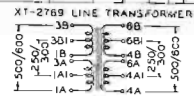
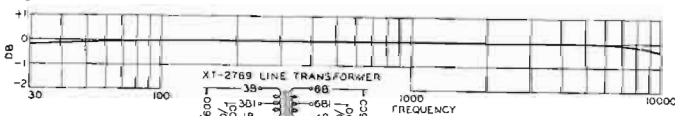
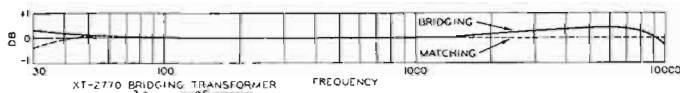

ALL CURVES FALL BETWEEN LIMITS SHOWN

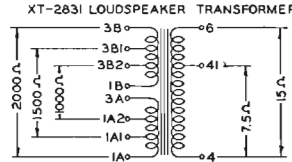
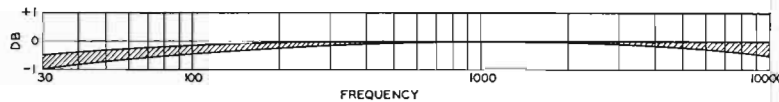

ALL CURVES FALL BETWEEN LIMITS SHOWN

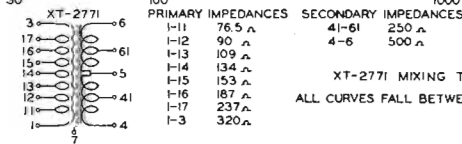
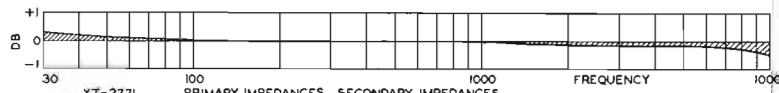

XT-2771 MIXING TRANSFORMER
ALL CURVES FALL BETWEEN LIMITS SHOWN

RELAY AND SIGNAL LAMP POWER SUPPLIES

RELAY POWER SUPPLY MI-4308

The MI-4308 Relay Power Supply is a small single tube rectifier which has been designed to furnish an output of 12 volts at 1 ampere, D.C. for relays and signal lamps. The input is 110/120 volts, 50/60 cycles, A.C. One Rectigon No. 289415-C tube is used in a half wave rectifying circuit. The cabinet size is 10 1/4" high, 8 3/8" wide and 4 5/8" deep. Two 1/2" con-

duit knockouts are provided in the bottom. Mounting strips on the rear provide four 5/16" diameter mounting holes on 11 1/2" x 7" center lines. The unit weighs about 18 lbs.

RELAY SUPPLY UNIT MI-1520

This unit is described in the Measuring Equipment section on page 94.

RCA MONITORING LOUDSPEAKERS

CABINET TYPE 64-AX

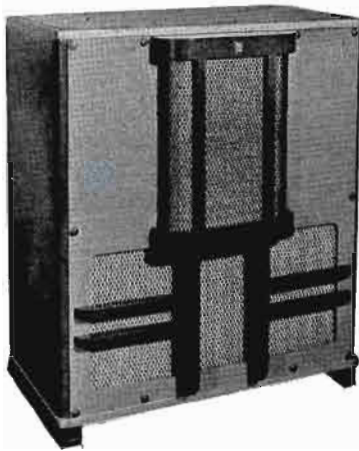

THE Type 64-AX Monitoring Loudspeaker has been designed to fill the need for high-quality speakers suitable for use in control rooms, audition booths, offices and other points about the studio. It provides exceptionally good reproduction fidelity, is of convenient size, and presents an attractive appearance.

The Type 64-AX Loudspeaker is not simply a conventional loudspeaker unit mounted in a box—but a perfected equipment of matched design. The speaker unit itself consists of a double-voice coil unit. This unit is so designed that it provides reproduction over a much wider band of frequencies than do most other types. Further improvement is obtained by use of an especially-designed cabinet.

The speaker itself is mounted behind the top grill. The rear of the unit, instead of being open, is enclosed by a series of acoustic filter chambers of increasing sizes which open into the large grille at the bottom of the unit. This arrangement provides the equivalent of an eight-foot baffle, in addition to eliminating cabinet resonance. Moreover, since the back of the console is enclosed, the location in the room has no effect on the frequency response.

A feature of the 64-AX Speaker is its wide angle of radiation in contrast to the usual sharp beam of ordinary speakers. This is made possible by the use of special diffuser vanes. Users of 64-A Loudspeakers may now obtain these diffusers in kit form for installation on their equipment.

The Type 64-AX Monitoring Loudspeaker can be operated from a Type 82-A or 94-D Amplifier, field supply being obtained from the amplifier. Additional speakers may be operated by adding more amplifiers across the line. If desired, the amplifiers can be mounted in a matching base which is available. The Type 64-AX Loudspeaker can be supplied with a speaker unit operating with a field supply of 56 volts, .215 amperes—or a field supply of 110 volts .10 amperes. The latter can be obtained from a Type 79-A Field Supply Unit (to be ordered extra) or similar source. The 79-A may be mounted inside the 64-AX speaker cabinet if desired. The pedestal base unit may be placed beneath the speaker to contain the power supply or amplifier if desired.

SPECIFICATIONS

Input Impedance: 15 ohms. Maximum Power Input: 10 watts. Field Coil: two models of speakers are available, MI-4466, operating from a 110 volt DC .10 amp. supply and the MI-4467 for 56 V. DC, .215 amp. 56 volts each. Frequency Response: 60 to 10,000 cycles. Finish: Black, umber gray—or walnut. Dimensions: 33 $\frac{5}{16}$ " high, 28 $\frac{1}{8}$ " wide, 16 $\frac{3}{8}$ " deep. Base Cabinet: MI-4437 Black, MI-4438 Walnut, MI-4432-A Umber Gray. Dimensions: 30 $\frac{3}{16}$ " wide—16" high—17 $\frac{1}{4}$ " deep.

UNMOUNTED UNITS Types UZ-4209 and UZ-4309



THE TYPES UZ-4209 and UZ-4309 Units are unmounted 8" high-fidelity loudspeakers especially designed for use with RCA Deluxe Speech Input Systems. They are particularly useful in control booths, and other locations where floor space is limited, in that they can be mounted on flat baffles and suspended from the ceiling or wall. Mounted in a large flat baffle, they have a uni-

form response of 90 to 8000 cycles and a useful response of 30 to 14,000 cycles.

SPECIFICATIONS

Max. Output: 10 watts. Frequency Response: according to mounting, see above. Input Impedance: 15 ohms. Field Supply Required: for UZ-4209, 56 volts, 215 MA; for UZ-4309, 110 volts, 100 MA. Dimensions: 10 $\frac{1}{2}$ " dia. x 8" deep.

TALKBACK AND CUEING SPEAKER Stk No. 32200, PERMANENT MAGNET



For talk-back and cueing purposes a low priced speaker is often desirable. The RCA No. 32200 is ideally suited for such applications. It has a voice coil impedance of 15 ohms and uses a permanent magnet. The overall diameter is 12 $\frac{1}{4}$ inches. It is rated at 10 watts and may be used with the MI-6294 cabinet for wall or table mounting.

FIELD POWER SUPPLY Type 57-A



The RCA 57-A Field Supply utilizes one RCA-80 rectifier tube to deliver 110 volts D. C., at 100 milliamperes from a 110 volt, 50-60 cycle, A.C. source. Its dimensions are 7 $\frac{3}{4}$ " long, 3 $\frac{1}{2}$ " wide and 6 $\frac{3}{8}$ " high.

TRANSCRIPTION TURNTABLE

Type 70-C

With High Fidelity, Diamond Point Stylus Tonearm

THE 70-C Transcription Turntable is similar to the popular 70-A and 70-B equipments which have been used with satisfaction by hundreds of broadcasting stations. It is equipped with the newly developed high fidelity lateral tonearm employing a permanent diamond point stylus and is provided with a number of mechanical improvements. With the new lateral tonearm, a quality of reproduction is attained which results in an amazing improvement, especially with lateral transcriptions recorded with characteristics which permit full range reproduction. The frequency response of the pickup extends from 30 cycles to well over 9000 cycles and the harmonic distortion is unusually low. For playing records having a higher surface noise a variable high frequency cutoff filter is incorporated. This allows the range to be reduced to 6000 or 4500 cycles if desired.

The Type 70-C Transcription equipment is designed to operate at both 78 r.p.m. and $33\frac{1}{3}$ r.p.m. — the speed changeover being accomplished in one revolution of the turntable. Moreover, by adding the Type 71-C Vertical Tonearm, provision is made for reproduction of both vertical-cut and lateral-cut recordings. Finally, a large-size turntable is employed so that any size records up to 18" can be accommodated. As a result, this equipment is completely universal; that is, it may be used interchangeably to reproduce vertical-cut transcriptions, lateral-cut transcriptions, both for $33\frac{1}{3}$ and 78 r.p.m.



Type 70-C Turntable with vertical tonearm in use



Type 70-C Turntable with lateral tonearm in use

The complete equipment is housed in an attractive console finished in tones of umber gray. The high-torque synchronous motor is cushion-mounted on the bottom shelf of the console and is flexibly coupled to the main turntable-spindle. The latter is cushion-mounted in the top of the console. A fly-wheel, mounted on the main-spindle, together with a mechanical filter in the drive shaft, insure excellent speed regulation within four-tenths of one per cent at 78 r.p.m. and within six-tenths of one per cent at $33\frac{1}{3}$ r.p.m. The cushion-mounting of the motor and spindle housing, and cushioning of the suspension arms, adequately prevent noise and vibration pickup. Speed reduction is accomplished by means of a heavy duty ball-bearing speed-reduction mechanism operated by a speedshift button conveniently located on rim of the turntable disc.

SPECIFICATIONS

Pickups: Lateral (space for adding Type 71-C Vertical Arm). Recording: The RCA 72-C recorder may be used. Motor Regulation: 0.6% at $33\frac{1}{3}$ r.p.m.; 0.4% at 78 r.p.m. Output Level: (test record) —48 db. Power Supply: 105 volts, 60 cycles, 35 watts. Cabinet Dimensions: 25" wide, $23\frac{1}{2}$ " deep, 31" high. Weight: 140 lbs. Finish: UMBER GRAY. Variable pass scratch filter and lateral tone arm lift included. NOTE: 25 and 50 cycle turntables can be furnished.

RECORDING ATTACHMENT Type 72-B

*A Convenient Attachment for Making
High-Quality Recordings At Low Cost*



THE TYPE 72-B Equipment is a relatively simple cutter head and arm which, when used with the type 70-A or 70-B Transcription Turntable allows any station to make acetate recordings inexpensively and conveniently. Such recordings have many uses—as, for rehearsals, for auditions, for permanent record, etc.

The Type 72-B Attachment is a single unit, complete in itself, and is easily mounted on the turntable. Because of the high cutting efficiency it can be operated directly from the studio or monitoring amplifier. Either the Victor Recording Discs or any of the popular makes widely available can be used.

SPECIFICATIONS

Audio Power Required: 3 watts. Cutter Impedance: 15 ohms.
Frequency Response: 60 to 6000 cycles.

FREQUENCY COMPENSATOR FOR 71-A AND 71-B

THE MI-4898 Compensator is the same as the one furnished with the 71-B1 Vertical Pickup. It is offered for separate sale to users of 71-A and 71-B Vertical Pickups to enable them to bring their equipment up to date. The MI-4898 Compensator is designed to give a sufficient low frequency boost and a high frequency attenuation in the output of the RCA Vertical Pickup head to produce an essentially flat response of from 50 to 7,000 cycles from present day standard vertical recordings.

VERTICAL TONEARM ATTACHMENT . . . Type 71-B

*A Perfected Tonearm for Reproduction of
Vertical-Cut Recordings*

THE TYPE 71-B Vertical Tonearm Attachment Kit is designed to be used with the Type 70-A or 70-B Turntable. It consists of a tonearm similar in appearance and construction to the lateral tonearm of the 70-B, a pickup head of the moving-coil type with a diamond point stylus, and necessary auxiliary items. The frequency characteristic of the Type 71-B is correctly sloped to provide uniform response from 50 to 7,000 cycles—insuring reproduction fidelity at least equal to that of any pickup of this type yet developed. The 71-B Tonearm, added to the 70-B Turntable, makes the latter a completely universal reproducing equipment.

SPECIFICATIONS

Pickup Type: Vertical. Needle: Diamond point. Frequency Response: 50 to 7,000 cycles. Output Level: (test record) —63 db.

BOOSTER AMPLIFIER KIT FOR 70-A, 70-B AND 70-C TURNTABLES . . . MI-4855

THE MI-4855 Booster Amplifier Kit is available for use with the 71-A and 71-B Vertical Tonearms or the Lateral Tonearms to increase the output level either to obtain greater amplitude or to permit the use of a bass compensator. The latter may be desirable to allow for lower levels in recording at the low frequencies but will tend to reduce the output. With the 71-A tonearm, a type T reactor may be used for compensation. A bass boosting filter is supplied with 70-B turntable and with the MI-4857 kits. The amplifier kit provides for mounting the booster amplifier in the turntable so that the level fed from either vertical or lateral tonearms will be approximately equal. It comprises an 85-A Preamplifier, an MI-4303 power supply, an MI-4170, 15 db. T pad and an MI-4868 kit of installation material. Full mounting instructions are furnished for installation in either the 70-A or 70-B tables.

HIGH FIDELITY RECORDING HEAD

MI-4887



THE MI-4887 High Fidelity Recording Head has been designed for use with the RCA 72-B and 72-C Recording Attachments as well as for similar recording equipments using spring suspended cutters. Its use permits

a much higher recording level than can usually be obtained with similar units. The MI-4887 has a uniform frequency response from 30 to 10,000 cycles and distortion in records made with it is extremely low.

The MI-4887 recording head is a band pass mechanical network terminated in a dry mechanical resistance material. The armature is of the balanced type and is centered by means of a tempered steel spring. The armature is supported on rugged knife edge bearings. Pole pieces are of nicaloi. Since the weight of a thumbscrew cannot be tolerated in a wide range head, a small clamping screw is provided and can be tightened with a small jeweler's screw driver which is furnished.

An impedance compensating network is furnished with the MI-4887 Head and the total input impedance remains sufficiently close to 15 ohms

throughout the frequency range. An amplifier having at least 8 watts output is recommended to provide a safe margin for driving the cutter.

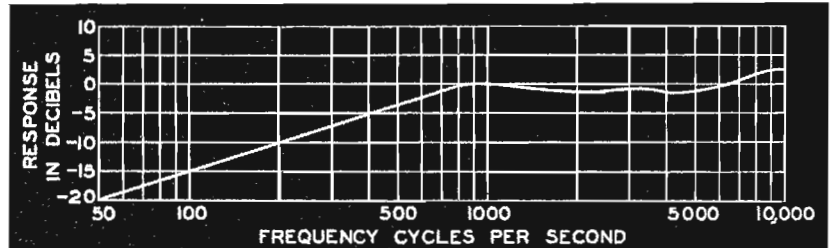

Frequency response of MI-4887 based upon optical measurement of the stylus tip motion for constant input

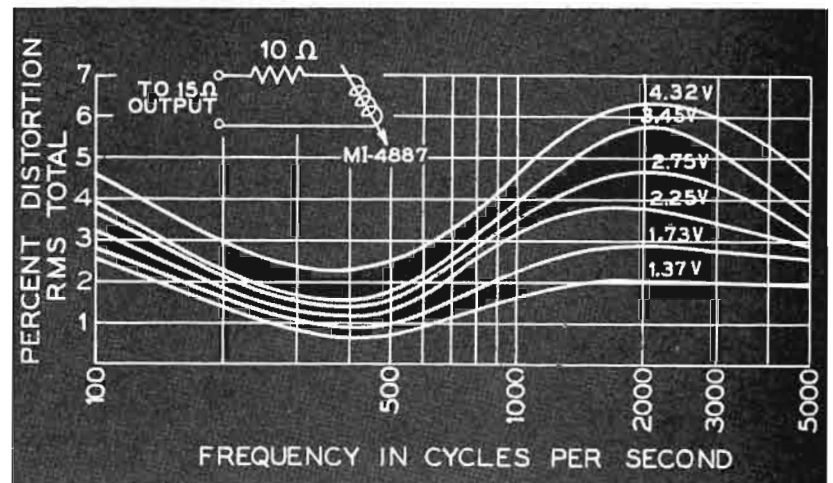

Distortion measurements made on the MI-4887 Recording Head

MI-4888 FLOAT STABILIZER

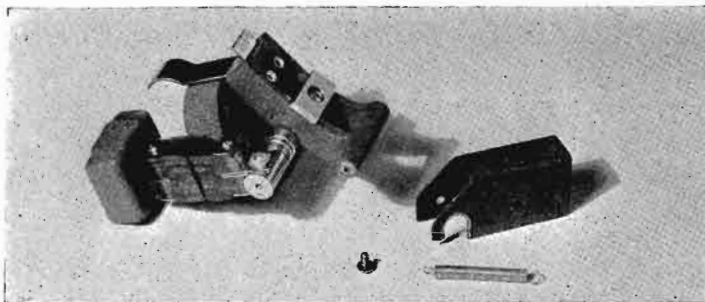

THE MI-4888 Float Stabilizer has been designed to eliminate recording flutter which is caused by a vertical oscillation of the cutting head. Such oscillations result from irregular record surface, motor unbalance, building vibration etc., and usually approximates 30 cycles. Flutter which is bad enough to spoil reproduction is generally visible in the record before it is played. It can be seen as

a water mark pattern, a series of spirals nearly concentric with the groove, or as a series of "spokes" depending on the phase relation. The stabilizer consists of a flat spring coated with a special mechanical resistance material and has a lead weight at one end. When added to the float arm of the 72-B it insures the absence of objectionable or audible flutter in reproduction from lacquer coated discs.



Float Stabilizer mounted on the type 72-B recording attachment

FIELD AMPLIFIER EQUIPMENT

OP-5 *A New and Flexible Battery Operated Unit*



THE OP-5 is a battery operated field amplifier which will appeal to every station because of its small size, its low price, its flexibility and completeness as well as its high fidelity performance. Designed for broadcast use outside of the studio, the OP-5 has been constructed to conform to the recommendations of leading broadcast engineers.

The OP-5 is unusually light and portable. Weighing only 36 lbs. completely loaded with batteries, it is scarcely larger than a good size briefcase and is easy to carry through taxi doors or to inaccessible locations. In spite of the light weight, shielding is complete; strong but light-weight alloys make the case and framework husky and able to stand hard usage.

Engineers will appreciate its completeness and flexibility. Containing provision for mixing four high fidelity, low output level microphones, the OP-5 is provided with an illuminated V. I. meter (and a separate light battery) which can be switched to read battery voltages and tube plate currents. OP-5X Models are also available with the newly recommended VI meter movement and 1 milliwatt zero reference calibration. Line key switches enable either of two lines to be connected to the output of the amplifier or to a socket where an interphone may be plugged in. Other controls include a power switch, filament rheostat, V. I. multiplier tap switch, master gain control and light switch. Tubes are reached by a door in the front panel and the entire chassis may be removed from its case by loosening four thumb screws.

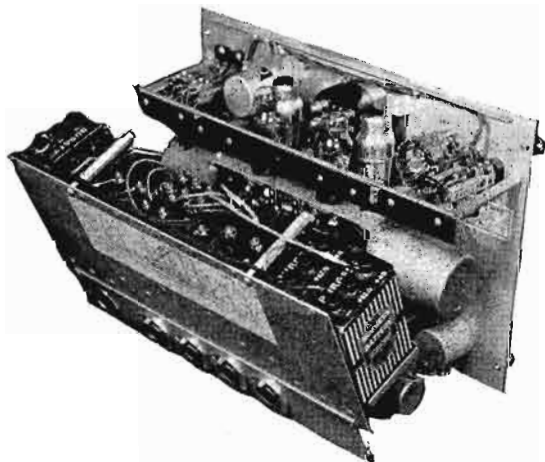

Rear View of the OP-5. Partially Opened. Battery Mounting Hinges to Permit Complete Accessibility to All Parts

The circuit of the OP-5 is straightforward including four resistance coupled stages with transformer input and output. The specially developed RCA 1609 pentodes are used. These tubes result in high gain with low battery drain and have been especially constructed to avoid microphonic troubles. Feedback is employed to insure minimum distortion and to provide a more exact impedance match with lines differing slightly from 500 ohms.

Performance of the OP-5 is particularly good. The distortion is below 0.6% RMS from 50 to 4000 cycles. Frequency response is uniform from 30 to 10,000 cycles within ± 1 db. The noise level will be less than -58 db. for normal operation. The overall gain, 90 db. is sufficient for high fidelity microphones. This equipment therefore, forms suitable apparatus for every remote program from sports to symphony concerts.

The self-contained batteries of the OP-5 enable it to be used anywhere, regardless of power supplies and without the necessity of making connections. The dry batteries used provide for long life and minimum expense. In every respect, in fact, the OP-5 is an unusually useful and convenient field amplifier which every station can well afford to own.

For protecting the OP-5 case against wear and weather, a covering case is available. It is made of "Cravenette" and provided with a zipper fastening. Stock No. MI-11600.



SPECIFICATIONS

Impedances: Input, 250 ohms or 50 ohms, as specified. Output, 500/600 ohms. Output Level: +19 VU db. maximum. Gain: 90 db. overall. Fidelity: Flat ± 1 db. 30-10,000 cycles. Distortion: Less than .6% R.M.S., 50-4,000 cycles at +14 VU output. Noise Level: Below -47 VU. Tubes: Four—RCA-1609. Batteries: 2 Little 6 dry cells (Burgess No. 4 F. H.) 1 C. Battery (Burgess A8BP). 1 C Battery (Burgess 2370). 4 45V B Batteries (Burgess 2-30-PX). Receptacles: 4 Cannon Microphone Receptacles; and Hubbell 2 connector socket for interphone; binding posts for 2 lines located on front of panel. Dimensions: $11\frac{3}{4}$ " high, $18\frac{1}{4}$ " long, $8\frac{1}{2}$ " deep. 36 lbs. weight fully loaded. Finish: Gray wrinkle.

62-A FIELD AMPLIFIER EQUIPMENT

A High Quality A.C. Equipment of Simplified Design

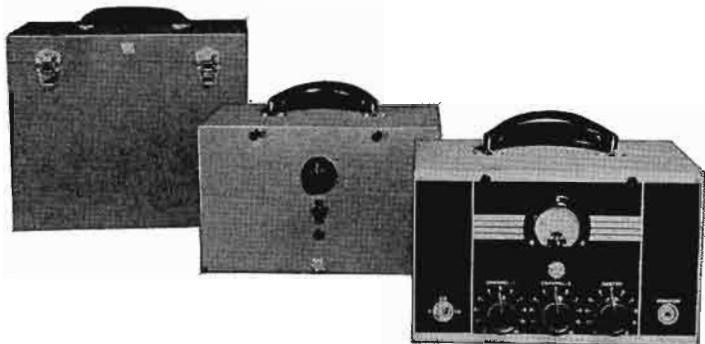

THE TYPE 62-A Remote Equipment is one of the most unusual equipments ever designed for this use. It is extremely portable—smaller and lighter than most other equipment—and simplified in design, yet it is capable of excellent performance and is surprisingly convenient in use. It provides for use of high-quality microphones; incorporates two pre-amplifiers, a high-level mixing system; a four-stage amplifier, master gain control, volume indicator, monitoring jack, plug-in-type input and output connections, and a regulated power supply. Thus, while it has but two mixers and lacks some of the convenience features of the deluxe models, it does provide all of the facilities absolutely essential for field work,—and it makes possible high-quality pickups at low expense. Many stations are finding that they must maintain a number of remote pickup equipments, and for these, as well as for smaller stations, this equipment seems to be the answer.

Mechanically the Type 62-A Equipment consists of two units, one the amplifier and the other the A.C. power supply. These are housed in identical cases finished in gray crackle and provided with strong carrying handles. Since these are only 7" x 12" x 7" in size, and weigh only about 20 lbs. apiece, they are exceptionally easy to handle. Each of the cases is hinged at the bottom rear so that they may be opened by removing two thumb screws. Interconnecting and power supply cables are furnished. The plug-outlets mounted on the back of the two units are of a type which have been found entirely satisfactory,—however, special models can be furnished on which more expensive (Canon) type plugs and receptacles are provided.

The Type 62-A Equipment has input connections for two high quality microphones (a third can be accommodated by using an external mixer). The input circuits are carefully shielded and the input transformers housed in heavy nicoloid cases. They feed separate pre-amplifiers each of

which uses an RCA 1603 "low-noise" tube. The outputs of the two pre-amplifiers are combined in a high-level mixing system, which is followed by a three-stage amplifier consisting of an RCA-1603, an RCA-6A6 and two RCA-6A6's push-pull. Overall gain is controlled by an interstage volume control. A copper-oxide rectifier-type volume indicator provides for visual monitoring. The indicating meter has standard markings (−2, 0, and +2 db.*). Alternative ranges of 0 db.* and +6 db.* are provided by a two-position switch. The power supply unit includes special regulating circuits which maintain constant output voltages independent of the AC supply. Where it is desired to use the Type 62-A Equipment with battery supply, a battery box (to be ordered separate) is available. This is 13" x 11" x 7" in size, and provides the necessary space for all batteries.

SPECIFICATIONS

Input Impedances: 50/250 ohms. Output Impedance: 500/600 ohms. Overall Gain: 86 db. Normal Output Level: 0 db.* Frequency Response: within 1 db. from 50 to 7000 cycles (within 3 db. from 30 to 10,000 cycles). Harmonic Distortion: (arithmetic sum) 1.0 percent at normal output. Background Level: (unweighted) −50 db.* Dimensions: amplifier unit is 7" x 12" x 7", power supply unit is 7" x 12" x 7", battery box is 13" x 11" x 7". Weight: of amplifier unit 20½ lbs., power supply unit 24 lbs., and of battery box (with batteries) 27 lbs.

* Odb = 12½ milliwatts = +11 VU.



HOW TO ORDER EQUIPMENT



ORDERS for apparatus should be placed directly with the nearest broadcast district representative for most efficient handling. A list of addresses is given on the frontispiece of this catalog. However, in cases of emergency at night or on holidays, orders may be telephoned or telegraphed directly to the factory at Camden, N. J. (telephone Camden 8000) where the emergency service representative will handle. It is advisable in all usual cases to communicate with the closest office to obtain most rapid service and thus to assure the services of the district representative whose duty is to be certain that the needs of the station are satisfied. If in doubt on any point, consult the representative who will be glad to supply full information.

Prices are not given in this catalog but can be obtained from the district office. Prices are quoted net, f.o.b. factory and are subject to change after 30 days. Shipments are usually made from Camden, N. J., on all items except speech input equipment which is usually stocked in Indianapolis, Indiana. Prepayment of carrier charges can be made on arrangement.

Always give the type number, catalog number or stock number of the apparatus ordered to prevent any chance of error. Also specify in detail whether accessories such as mountings, plugs or one set or two sets of tubes are to be supplied. An order for a 44-BX microphone, for example, will not include a plug or stand unless specified. Information on the included accessories is provided in this catalog and in bulletins. It is also advisable in telegraphic orders to state the name of the purchaser, if different from the station call letters and to give the call letters of the station also.

In ordering, always state the address to which the equipment should be delivered as well as the address to which billing should be rendered, if these are different, in order to make for convenient handling. It is also advisable to state the method of shipment desired. Power tubes should always be shipped by express since this method of transportation provides

special handling as well as carrier insurance to the purchaser.

RCA equipment will be shipped as promptly as possible, usually on the same day or the following, but in the event of delay, notification of the expected delivery date can be given. In case of need, special methods can be used to expedite delivery and, providing the purchaser is willing to assume the carrier charges, shipments can be made by air mail, air express, passenger train baggage car, special truck, etc.

RCA broadcast equipment (with the exception of tubes) carries a guarantee against defects for a period of one year under normal conditions of service for which the apparatus is designed and providing it is not misused. This guarantee is assurance to the purchaser that the equipment will perform satisfactorily and carries the full backing of RCA. In the event of any difficulty, communicate with the district representative and not with the head office. If apparatus is to be returned for inspection or repair, obtain a return authorization tag from the representative. This will identify the equipment and assure prompt handling. Never send equipment to the factory without such a tag. The company cannot accept responsibility for articles returned without a tag, nor will it accept shipments with carrier charges collect.

RCA broadcast equipment is fully licensed under United States patents for the uses and purposes for which it is intended (although not in combination with other apparatus unless specifically stated) and a complete copy of the patent guarantee can be obtained on request.

Information in this catalog is intended to be as complete as possible. It is, however, subject to change without notice and for special information consult the district representative.

Engineering service in connection with the installation of RCA equipment is available to broadcasting stations. Consult representatives for rates and information.

Help us by following the above procedure to serve your needs, efficiently and promptly.



TRANSMITTERS

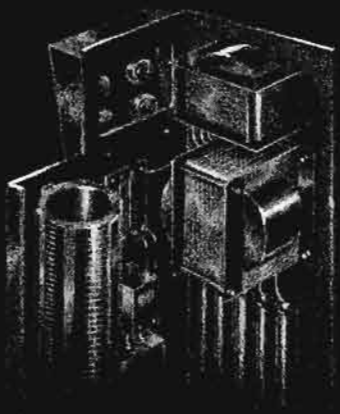

TRANSMITTERS

IN presenting transmitters for broadcasting service RCA has made performance and reliability the keynote of the design. Definite requirements must determine the circuit, the arrangement of components and the tube complement. It is not enough merely to build equipment which has a novel circuit unless it contributes to the performance. Features alone can mean nothing unless they furnish the purchaser with definite value. For years RCA engineers have investigated the problems of the broadcasting station in order to construct functional apparatus which will exactly meet the requirements of the user. Nothing is included which does not serve a useful purpose and nothing is omitted which is essential for good operation.

Performance is, of course, the prime consideration. Broadcast service demands a high standard of transmission quality and RCA transmitters are designed to provide uniform audio response within extremely close limits as well as low distortion and noise level. In RCA transmitters, distortion has been reduced to a point where it is no longer a noticeable factor, not only at the common measuring point of 400 cycles, but over the entire audio band from 50 to 7500 cycles. This has required careful design, but low distortion at one frequency is of no particular benefit if distortion is high at other frequencies. Likewise, noise level has been suppressed to a value where it does not limit the dynamic transmission range.

Economy of operation is important to the broadcaster and has been one of the chief design considerations. The selection of tubes, the type of circuit and the power supply systems have been arranged to reduce the hourly cost of operation. Since operating expense may be, during the life of the transmitter, of equal or greater amount than the initial cost of the equipment, savings which accumulate month after month reflect a very definite economy. Hence both tube cost and power drain have been very appreciably reduced. Part of the low tube cost is attained through the use of types which render many thousands of hours of service. Long tube life is a dividend to the station owner and RCA tubes help reduce the annual replacement expenditures.

Reliability is another essential factor. The loss of only a few hours time and the equivalent revenue might run into large figures. Hence RCA equipment is built to reduce outages to a minimum. Components are conservatively rated and of careful design to prevent failures. Only high grade materials are employed, and control circuits are designed to protect the apparatus against damage in any emergency.

Convenience of operation has also been given careful consideration. The equipments are physically small to avoid the need for large buildings, but not so small that

accessibility is sacrificed. RCA transmitters avoid circuits which require laboratory apparatus for proper adjustment and their straightforward circuits are a guarantee of reliable operation. Many other features of the design contribute to convenient operation, such as ready access to tubes and components, complete metering, automatic sequence starting and automatic power change devices. RCA transmitters are shipped assembled and with but a few parts removed for safety during transit. Thus time and money are saved during installation.

RCA design goes far beyond the requirements of the accepted standards for good engineering practice, and features incorporated may not be readily apparent on casual examination. Some insulation looks like Ceramic or Mycalex, but RCA insists on using high grade materials which will not absorb moisture nor develop high resistance leakage. Rust proofing on metal cabinets and frames is covered by the exterior finish, but it still exists as a layer of protection against corrosion. Deficiencies in design could be minimized by compensation, but it is often dangerous to depend upon corrective measures as a substitute for good engineering, and RCA does not tolerate such practice.

Another factor which is not immediately apparent, but of prime importance to the purchaser, is the careful test of components and of the overall equipment. RCA insists on thorough testing of each piece of apparatus before release from the factory.

The process of design of new equipment, as carried out in RCA laboratories, is thorough in the extreme. After the circuit design has been completed on paper, a model is usually made, on which elaborate measurements are carried out. From this, the finished design is evolved and the final model is subjected to many tests of use and misuse. Every sort of operating condition is duplicated as nearly as possible in order to assure trouble-free service. Elaborate test equipment is necessary and due to RCA's extensive facilities, this is readily available and utilized. Thus when an RCA transmitter is delivered to the station, the purchaser can be assured that every precaution has been taken to provide high fidelity, economical, trouble-free operation.

Back of the transmitters which RCA offers for sale, lies capable engineering, extensive production facilities, a careful test system and an organization determined to produce functional apparatus at reasonable prices. That is why many stations insist on RCA equipment throughout. Note the individual features of the transmitters described in the following pages and see why RCA equipment does a real job in broadcasting stations and why it pays to go "RCA All The Way."

SOME OF THE STATIONS WHICH HAVE PURCHASED RCA BROADCAST TRANSMITTERS

(U. S. Only)

KABR	KMA	WAGA	WFAM	WKY	WSIX
KARK	KMAC	WALR	WFBC	WLAW	WSJS
KARM	KMED	WAML	WFBR	WLB	WSLI
KASP	KMPC	WATL	WFBM	WLEU	WSM
KBND	KMTR	WAVE	WFIL	WLS	WSNJ
KBST	KNX	WBEN	WFMJ	WLW	WSWV
KDYL	KOB	WBEO	WGAR	WMAS	WSYB
KECA	KOBH	WBNS	WGBR	WMBC	WSYR
KEHE	KOIL	WBNY	WGH	WMBO	WTAG
KELD	KOKO	WBRC	WGIL	WMBS	WTAM
KELO	KOMO	WBRE	WGNY	WMCA	WTAQ
KFAM	KOSO	WBSP	WGPC	WMFJ	WTAR
KFBK	KOY	WBT	WGR	WMFR	WTAX
KFDA	KPDN	WCAE	WGRC	WMRO	WTJS
KFEQ	KPFA	WCAO	WGST	WMWV	WTIC
KFI	KPLT	WCAU	WGVA	WNBC	WTMA
KFJZ	KPMC	WCAX	WHBC	WOAI	WTMV
KFRO	KPPC	WCBM	WHBF	WOC	WTRC
KFWB	KPRC	WCBS	WHBL	WOMI	WWJ
KFYO	KRBC	WCFL	WHEC	WOR	WWL
KFYR	KRNT	WCKY	WHIO	WORC	WWNC
KGCP	KROC	WCOP	WHLS	WPEN	WWSW
KGCX	KSD	WCOU	WHO	WPIV	W1XBS
KGER	KSO	WCSH	WHOM	WPTF	W1XOU
KGGC	KSRO	WDAN	WIBA	WPWV	W2XE
KGHL	KTBS	WDAS	WIBC	WQAM	W2XJI
KGKB	KTEM	WDBJ	WIBW	WQBC	W2XQO
KGKO	KTOK	WDEV	WILL	WRAK	W3XEY
KGLO	KTRH	WDOD	WIOD	WRAW	W3XIR
KGW	KTRI	WDRG	WIP	WRC	W4XBW
KHBC	KVCV	WDZ	WIRE	WRDH	W4XFJ
KHBG	KVEC	WEAF	WISN	WRDO	W5XAU
KHSL	KVOS	WEBR	WJBK	WRDP	W6XDA
KHWB	KVSO	WEEU	WJDX	WRDS	W7XDQ
KIEU	KWFT	WELI	WJHL	WRDW	W8XAY
KITE	KWLK	WEMP	WJIM	WREN	W8XUM
KIUL	KXOK	WENR	WJMC	WRNJ	W8XWJ
KIUN	KYA	WEVD	WJMS	WROK	W9XI
KJR	KYSM	WEW	WJRD	WRTD	W9XLA
KLAK	WACO	WFAA	WJZ	WSBT	W9XOK
KLZ					W9XPD

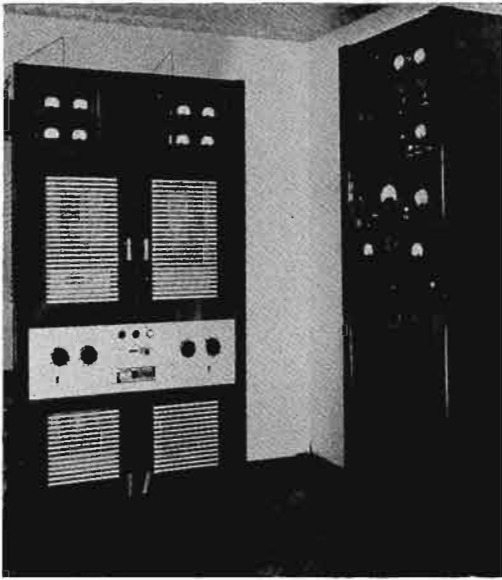

KRBC Uses a 250-D High Fidelity Installation

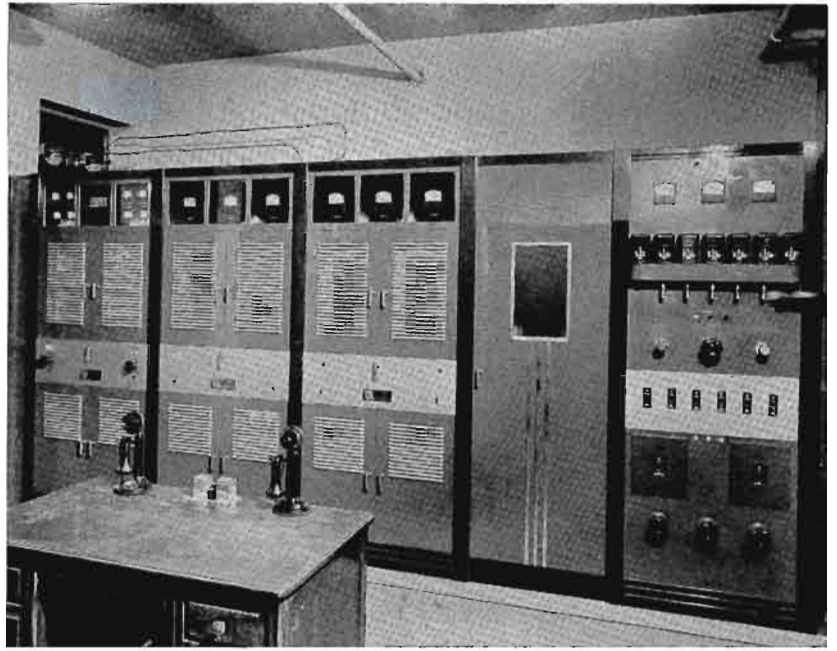

WJDX Was First of the Many 5-D Installations

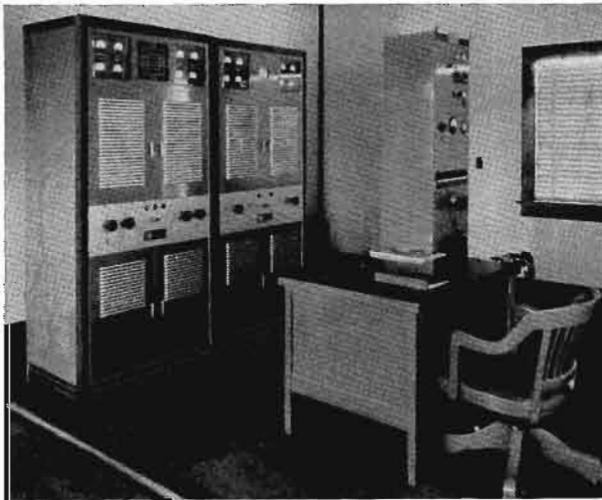

▲ *The 1-DA Installation at WAGA*

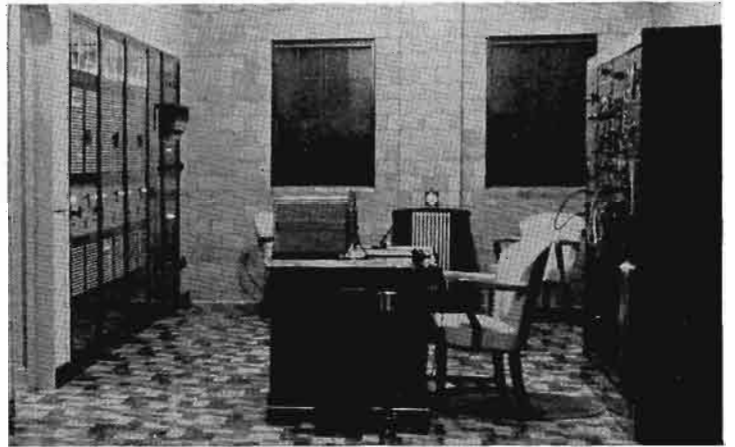

(Above right) *The RCA 5-D Transmitter at WBNS*

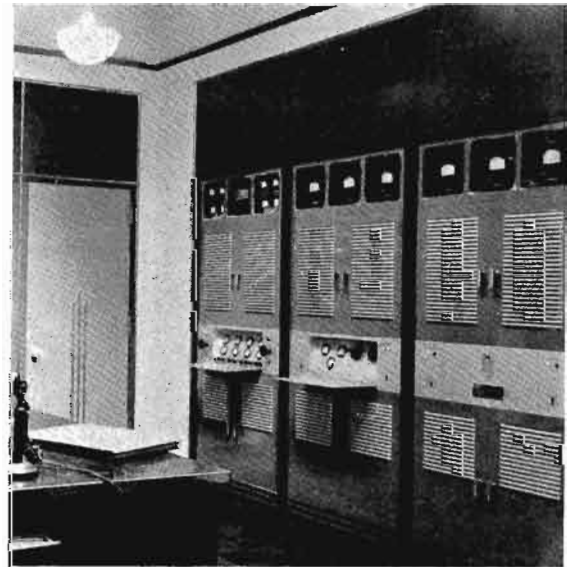
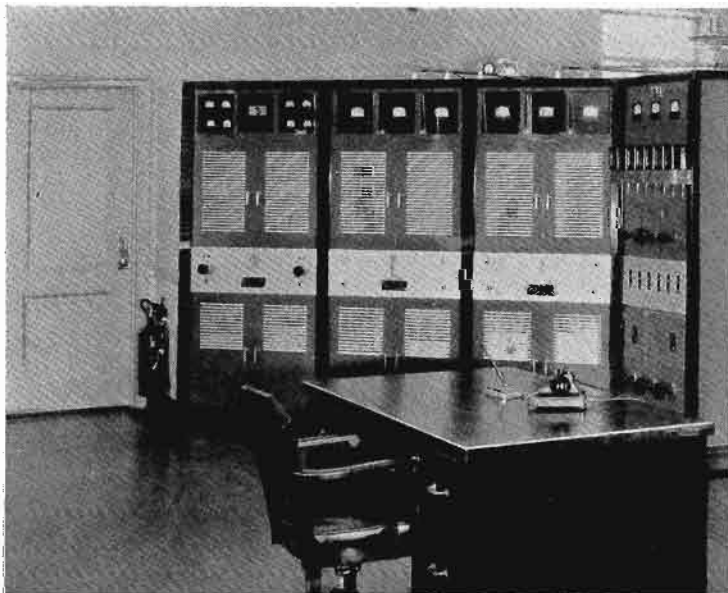

▲ *A 5-D installation is employed at WGAR.*

◀ *(Left) The 5-D installation at WRC.*

De Luxe 250-D TRANSMITTER

THE 250-D transmitter is RCA's de luxe 250 watt equipment for progressive stations which want the best and most reliable apparatus. Complete, easy to operate, provided with many automatic features, it is a truly high fidelity transmitter of the first order. In addition it is economical to operate, uses the latest high efficiency tubes and may be supplemented by amplifiers to increase power to 1000, 5000 or 50,000 watts. These are the reasons the 250-D has been chosen by leading stations.

The 250-D uses the simple and efficient high level modulation circuit which is easy to adjust and keep in correct operating condition. It employs a modern tube lineup—RCA-802 oscillator; RCA-802 buffer; RCA-805 intermediate amplifier, and two RCA-805's as power amplifiers. The audio lineup consists of two RCA-843's driving two RCA-845's which drive two RCA-805's as modulators. Complete duplicate crystal oscillators are furnished, each equipped with a low temperature coefficient "V"-cut crystal.

For operating convenience, 16 meters are provided to indicate the conditions of all circuits and facilitate tuning.

A voltage adjustment switch is mounted on the panel to compensate for variations in supply voltage. Output coupling is variable and controlled from the front panel so that full output can be maintained in spite of changes in the antenna characteristics. Crystal units may be switched from the control panel. Power changes between 100 and 250 watts can be made instantaneously by a single switch which automatically adjusts the audio input for the correct modulation level as well as compensating the modulation meter. All tuning is done through dental cables, thus enabling apparatus to be located for most efficient circuit operation. Automatic starting is provided and a built-in dummy antenna is included.

Mechanically, the 250-D represents an important advance by the use of vertical chassis construction. With all apparatus mounted on the vertical surfaces, any piece of equipment can be easily reached for inspection without removing any other part. Other important mechanical features include isolantite or mycalex insulation for radio frequency, circuit breakers instead of fuses, all tubes accessible through front doors, Pyranol condensers, standard rust-proofed steel panels and sturdy, welded frame.

The transmitter is attractively finished in two tones of gray and

satin chrome. The cabinet is highly polished and waxed to make it easy to keep clean and shining. Interior surfaces are finished in opalescent lacquer. The 250-D comes completely assembled, too. Only a few small items need be mounted when the transmitter is unpacked in order to set it up ready for connection.

For performance, it is difficult to match the 250-D. Harmonic distortion is below 3% over the audio band from 50 to 7500 cycles. Frequency response is flat within 1 db. and hum level is below minus 60 db. The high efficiency output circuit guarantees full rated power in the antenna. Power consumption is only 1.7 kw. Replacement tube cost has been reduced to the minimum by low priced, long life tubes. Thus the 250-D is a transmitter properly designed, carefully engineered, tested and retested, which will offer a long and useful life to the purchaser.

SPECIFICATIONS

Fully approved for use by the Federal Communications Commission.

Rated Operating Power:

100-H Transmitter**	100 watts
250-D Transmitter	250 or 100/250 watts
Radio Frequency Range	550 to 1600 kcs.
Radio Frequency Stability	±10 cycles
Radio Frequency Harmonics below	.05%
Modulation Capability	100%
Audio Input for 100% Modulation	+4 VU (−6 db.)*
Audio Input Average Program Level	−2 VU (−12 db.)*
Audio Frequency Response (±1 db.)	max. 30 to 10,000 cycles
Audio Distortion (50 to 7500 cycles) max.	3% RMS
Background Noise and Hum Level (unweighted)	−60 db.
Power Supply	110/220 volts, 50/60 cycles
Power Consumption (average program):	
100-H Transmitter	1400 watts
250-D Transmitter	1700 watts
Dimensions (overall)	38 ³ / ₄ " x 25 ¹ / ₄ " x 84 ¹ / ₈ "
Weight	1400 lbs.
Weight (packed)	2000 lbs.
Tubes for 100 watt operation:**	3-802‡, 3-838, 2-843, 4-845, 6-866-A, 1-5Z3.
Tubes for 250 watt operation:**	3-802‡, 3-805, 2-843, 2-845, 2-805, 6-866-A, 1-5Z3.

‡ Including spare oscillator.

* Zero db. equals 12¹/₂ milliwatts.

** When used for 100 watts only, the 250-D is designated as the 100-H.

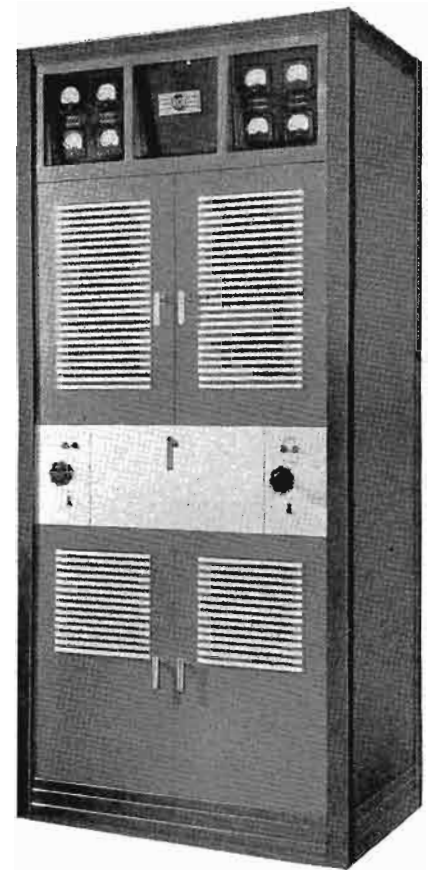

De Luxe

1000 WATT TRANSMITTER

Type 1-E

SECOND unit in the RCA line of deluxe transmitting equipments is the Type 1-E Transmitter. This is designed for stations operating with licensed powers of 1000 watts, 500 watts 500/1000 watts or 250/1000 watts. It consists of two units which match in appearance and dimensions, and are integrally designed for use together. One of these is the Type 250-D Exciter unit (see opposite page), the other is a 1 KW amplifier-modulator unit of new design. The latter is available separately (for use in increasing power of existing 250-D installations), or the two units are available together as a complete 1000 watt transmitter.

The 1-E, like the 250-D, employs the newest-type high-efficiency tubes, and, like the 250-D it features straightforward circuits which make it one of the most efficient equipments of this power yet designed, and at the same time insure the simplest and most nearly foolproof tuning and operating procedure. High-level modulation is employed, the power amplifier consisting of two RCA-833's push-pull, and the modulator of two more RCA-833's also push-pull. The former are excited by the RCA-805's in the output stage of the 250-D Exciter. The latter are driven directly from the intermediate audio stage of the exciter —i. e. the RCA-845 stage. In addition to these power amplifier and modulator circuits the 1 K W unit contains a high-power plate voltage rectifier, using four RCA-872-A's, and a bias rectifier using two RCA-866-A's.

Many of the special features of the Type 1-E Transmitter are to be found only in this deluxe equipment. There is, for instance, a total of twenty-six meters, greatly facilitating tuning and operation. There is an auto-transformer for compensating for line voltage fluctuations, a variable output coupling system for maintaining power output at specified value, and a dummy antenna for testing operations. The control system is exceptionally complete,—providing not only protection for personnel and equipment, but also facilities for automatic or manual starting, instantaneous power changeover, etc.

Mechanically the 1-E follows the constructional lines of the exciter unit. All component parts are mounted on the back sides of vertically-mounted chassis, with all tubes on the front sides of the same chassis (in positions which simplify arrangement and wiring). The result is to produce a "chimney-flue" type of ventilation which provides unequalled cooling for tubes and other parts. Meters are grouped on tilted illuminated panels at the top of each unit (with access provided by hinged doors). Tuning controls are all on a small recessed sub-panel and operate

through flexible shafts having absolutely no back-lash. Similar details of the construction, appearance and finish are equally fine.

SPECIFICATIONS

Rated Operating Power.....	1000 watts
Radio Frequency Range.....	550-1600 KC
Radio Frequency Stability.....	±10 cycles
Modulator Capability.....	100%
Audio Frequency Response.....	(±1.5 db.) 30-10,000 cycles
Audio Distortion (50 to 7500 cycles).....	3% RMS max.
Background Noise and Hum Level.....	—60 db.
Power Supply.....	230 volts, 50/60 cycles, single phase
Power Consumption (no modulation).....	4.8 KW
Dimensions (overall).....	76 ¹ / ₄ " x 25 ¹ / ₄ " x 84 ¹ / ₈ "
Weight (approximate).....	3000 lb.

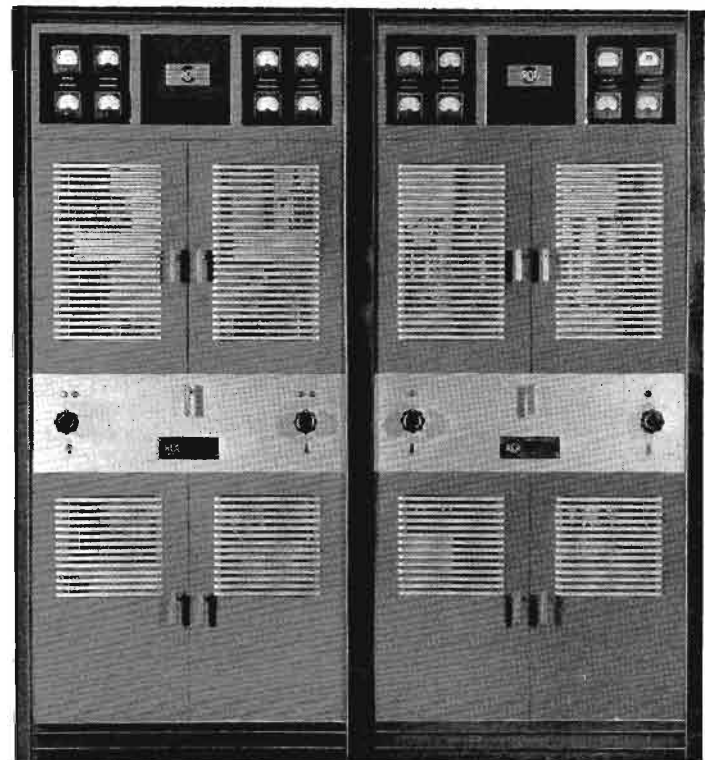

5000 Watt Transmitter

Type 5-D

A High-Fidelity Transmitting Equipment For High Power Regional Stations

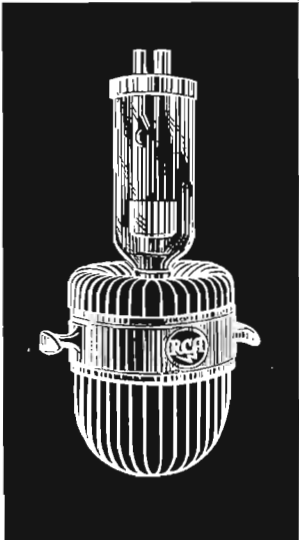

THE TYPE 5-D Transmitter, in addition to setting up new standards in transmission fidelity, incorporates design features—many of them entirely new—which cut installation and operating costs nearly in half, and which greatly facilitate operating and servicing.

Most unusual of the new features incorporated in the 5-D Transmitter is the fact that all tubes are air-cooled, thereby completely eliminating the bulky water-cooling

systems used with 5 KW transmitters of older design. The tubes used are standard water-cooled type tubes of proven long life. By mounting these in sockets provided with copper radiating fins (through which a stream of air is

blown by silent Sirocco Blowers, they are operated with the required power input without resorting to water cooling. Because of the high efficiency circuits used, the heat liberated is no greater than that from some older 1 KW Transmitters.

Another feature of the Type 5-D Transmitter is the use of high-level Class-B modulation. This method of operation results in efficiency more than double that of any previous design,—thereby greatly reducing the power dissipated in heating and, of course, reducing the total power required. This power saving, plus other savings, reduces average power input to 18.5 KW—or only a little more than half that of older designs. Together with the saving in distilled water and servicing costs, this results in an overall operating cost lower than anything before thought possible.

The Type 5-D Transmitter consists of four units, as shown in the accompanying illustration. These, from left to right, are exciter, power amplifier, modulator-rectifier and power control. The latter is separated from the first three units by a door which provides entry to the rear of

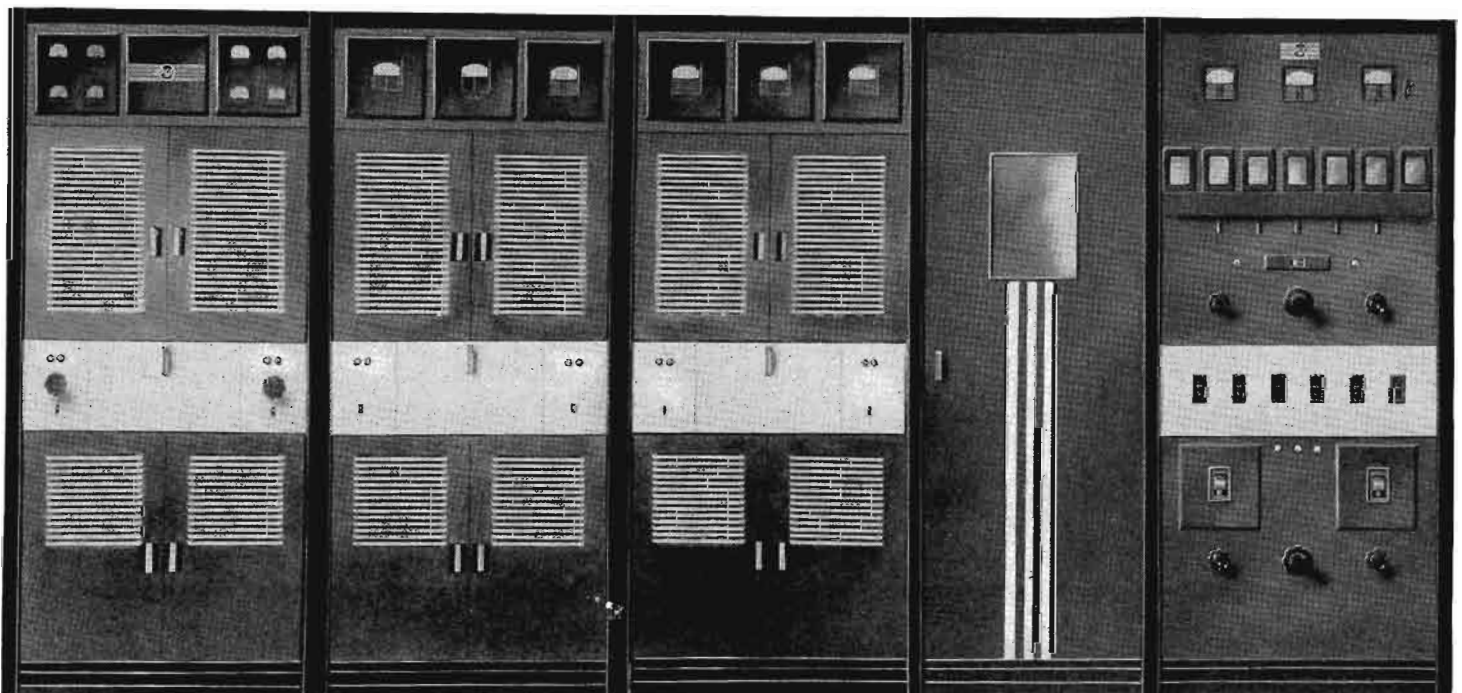

5-D Transmitter

the four units. The exciter unit is the 250-D Transmitter. The power amplifier uses an RCA-892-R, which is a standard metal-anode-type tube in an air-cooled mounting. The r-f output circuit is designed to feed into a concentric-type or an open-type transmission line—the plate tank circuits forming a low-pass filter for suppression of harmonics. An outdoor-mounting-type antenna tuning unit is supplied, which includes a tube rectifier for operation of a remote antenna current indicator. The modulator unit includes a built-in low-power audio amplifier, especially adapted for feed-back. The first stage uses a pair of RCA-1603's, the second stage a pair of RCA-807's and the third stage four RCA-845's push-pull parallel. The modulators are a pair of air-cooled metal-anode RCA-891-R's operated Class B. All audio stages are so designed so that phase turnover is avoided when feedback is utilized. The feedback circuit, an exclusive RCA development, is unique. It is push-pull connected, requires no adjustment (even when changing from 1 to 5 KW), covers a wide band of frequencies, and allows stable operation with 30 db. degenerative feedback.

The control system of the Type 5-D Transmitter is unusually elaborate. A new feature is the centralization of all of the relays, breakers and control apparatus on a special power-control panel, similar to the accepted practice in power work. Full automatic starting, proper sequencing of voltage applications, and overload and interlock protection are, of course, provided. In addition, there are a number of extra features as, for instance, the resetting device which, after interruption, returns the plate voltage automatically, performing this function three times before finally removing power. This also operates from the antenna power rectifier following arcover due to lightning or static charges. All the usual controls are provided, plus several added features—for instance, separate filament voltage controls for each of the high-power tubes, together with an arrangement for reading the actual filament voltages (thereby allowing longer life to be obtained).

The transmission fidelity of the Type 5-D Transmitter is particularly worthy of note. Actual measurements show that characteristics are practically as good as those of the low-power exciter unit, and are considerably better than those of any transmitter of comparable power. This has been made possible by use of a high-level modulation system, proper proportioning of the constants of the modulation circuit, and the unique feedback circuit employed. Distortion is less than 3% RMS from 50 to 7,500 cycles, and from zero to 95% modulation. This is for average operating conditions—careful adjustment reduces the distortion even further. The same factors result in reducing the background noise level and hum level so that this is in all cases at least 60 db. below 100% modulation for

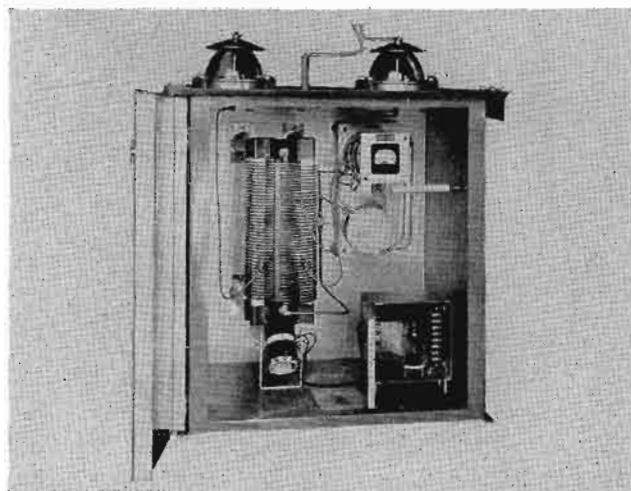

This Type 105 antenna coupling unit is supplied with the 5-D and 10-D transmitters. It includes provisions for remote reading of antenna current as well as audio monitoring.

unweighted measurement. The frequency response is uniform within 1.5 db. from 30 to 10,000 cycles.

SPECIFICATIONS

Rated Power: 5000 watts. R. F. Range: 550 to 1600 kilocycles. Frequency Stability: better than ± 10 cycles. R. F. Harmonics: .05% or less. Audio Input Required: 0 db. for 100% modulation, —6 db. for average program. Frequency Response: within 1.5 db. from 30 to 10,000 cycles. Audio Distortion: less than 3% RMS from 50 to 7500 cycles. Background Noise Level: —60 db. (unweighted). Power Required: 230 volts, three phase, 60 cycles, 16 KW with carrier (5 KW out). Dimensions: 14' 6" long, 7 ft. high, 3 ft. deep, transmitter proper. Weight: 10,500 lb. Weight: (packed) 12,000 lbs. Tubes: 3-802, 3-805, 8-866-A, 2-891-R, 1-892-R, 6-872-A, 1-5Z3, 2-1603, 2-807, 4-845, 1-83V. (Zero db. = $12\frac{1}{2}$ mw.)

10-D Transmitter

The RCA 10-D, 10 kilowatt transmitter, is similar in design to the 5-D equipment except that the final radio amplifier employs two RCA 892-R tubes instead of one. The second tube is mounted in a compartment directly in the rear of the radio amplifier section of the 5-D. Thus there is no change in dimensions of the panel width over the 5 kilowatt transmitter. Performance is similar to that of the 5-D and the same advantages of high efficiency, economy, easy adjustment and absence of water cooling are realized.

Stations using the 5-D or 5-DX equipment may increase to 10 kilowatts economically by the addition of a simple cabinet which houses the additional radio amplifier tube. The 5-D equipment has been designed with a modulator sufficient in size to handle the 10 kilowatt output. It is thus unnecessary to change the modulator section of the transmitter.

De Luxe
5000 Watt Transmitter
Type 5-DX

*A De Luxe Transmitting Equipment with New "Unified-Front"
Type Construction and Master Control Desk*

FOR those applications where an unusually impressive appearance is of advantage, RCA engineers, working in close collaboration with the RCA styling department, have designed a transmitting equipment which combines unapproached beauty and symmetry with the last word in operating convenience. Basically this new Type 5-DX Transmitter is identical with the Type 5-D Transmitter which has been described in detail in the preceding pages. Behind the front panel the four units of this new transmitter—i. e. exciter, power amplifier, modulator-rectifier and power-control,—are the same as those of the 5-D Transmitter. However, in the 5-DX Transmitter the whole assembly has been furnished with an overall "unified"—front panel of truly superb attractiveness.

Looking at the front view of this transmitter, as shown, an idea of the beautifully streamlined installation it makes possible is gained. But even so it fails to do this new equipment entire justice. Actually, when installed flush with the wall of the operating room and with indirect lights in the valance above, the impression is one of a

transmitter such as would be associated in the average expectancy with installations of five or ten years hence. As can be seen the three operating units are centered and provided with full-width doors having wide heavy grills. The power control unit (on the right) has a full-length non-interlocked door providing immediate access to relays, auxiliary controls, etc. On the extreme left is a door (interlocked) which provides access to the interior of the transmitter compartment. All doors, and the fixed parts of the "unified" front, are of $\frac{1}{8}$ " steel plate—this weight insuring that these will not "flex" or give. In fact the whole construction is especially sturdy and in keeping with the idea of an equipment in which nothing has been spared to provide the best. More on the utilitarian angle is the adaptability to air-conditioning. This may be carried out by exhausting air from behind the transmitter, thus drawing cool air from the operating room through the transmitter doors and out. Or, if desired, glass may easily be fitted behind the six grilled sub-doors, thus isolating the transmitter from the operating room and allowing each to be ventilated and cooled separately.

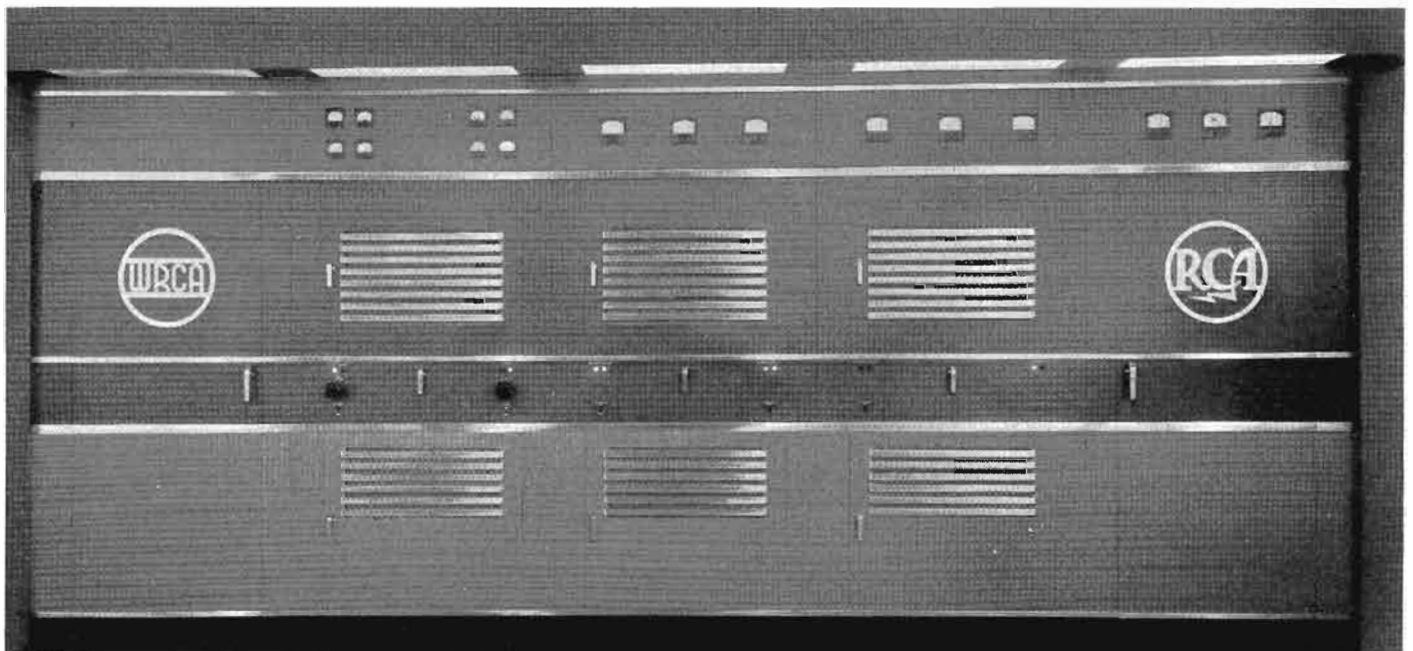

5-DX Transmitter

The second unusual feature of the 5-DX equipment is the operating console which is furnished with this transmitter as standard equipment. On this console are grouped all of the essential transmitter controls plus audio input switching and monitoring controls. Three meters on the center panel read antenna current, audio volume level and modulation. Built-in as a preamplifier so that a high-quality microphone is ready for announcements at a flick of a switch (similarly records may be played for testing, or for sign off, or in emergencies due to studio or line failure). There is also a monitoring amplifier with a bridging input—allowing monitoring across the audio input or from the antenna monitoring rectifier. And with all these circuits are signal lights, indicating at a glance the operation of the whole transmitter installation. Completely assembled, wired and tested at the factory this console saves much installation time, provides optimum performance and insures maximum convenience—plus the fact that it is a “matching” unit which adds to the beauty and distinctiveness of this unique transmitting equipment.

A constant increase in power has, over the years, been a definite feature of broadcast progress—and hence the feasibility of future power increases is always worth considering. To be practical, such possibility of change must consider the economics involved. For instance, an increase from 5,000 watts to 10,000 watts might not be justified if the expense involved were very large. But if this expense were relatively small it might be—and some stations have found it to be—very much worth while. The 5-DX provides for this situation as does no other transmitter. It is easily—and inexpensively—changed over for 10,000-watt operation by adding a very simple unit housing an additional amplifier tube. Only very minor changes in the existing installation are required. The converted transmitter is efficient, reliable and has quality equal to that of the original. Moreover, this does not make the installation an orphan, or a hybrid, for with this change the 5-DX becomes a 10-DX Transmitter—a standard unit which is registered with the FCC as such, and which is sold complete wherever a 10-kw. Transmitter is originally required. Only a small amount of space is required.

For stations operating on high-power regional channels future increases to powers greater than 10 kw.—as for instance, to 25 kw. or 50 kw.—are a distinct possibility, and hence worthy of consideration, even where present power is only 5 kw. or less. For these stations, the best of all possible assurances is given by the fact that the 5-DX Transmitter is the standard exciter unit used in the RCA 50-D Transmitter (designed for 25 kw. or 50 kw. operation). The exceptionally high quality of the 5-DX Transmitter, the low phase-shift, the high-level modulating circuit, and similar features make this not only practical, but highly economical. And note that, when the 50-D Amplifier is



added to the 5-DX Transmitter, there is no overlap, no waste; the 5-DX is used just as installed—with necessary field modifications limited to tying-in of interlock and control circuits. Thus, an increase in power is easily accomplished.

SPECIFICATIONS

ELECTRICAL SPECIFICATIONS

Carrier Power Output: 5,000 or 5,000/1,000 watts. Carrier Frequency Range: 550-1,600 kc. Carrier Frequency Stability: Within ± 10 cycles. Modulation Capability: 100%. Audio Distortion: Less than 3% r. m. s. 0-95% modulation, 50—7,500 cycles. Audio Frequency Response: Uniform within $\pm 1\frac{1}{2}$ db. 30—10,000 cycles. Carrier and Hum Level: Better than 60 db. below 100% modulation, unweighted. Power Input: 5 kw., 16 $\frac{1}{2}$ kw. without modulation, 18 $\frac{1}{2}$ kw. with average modulation; 1 kw., 10 $\frac{1}{2}$ kw. without modulation, 11 kw. with average modulation. Power factor approximately 90%, 230 volts, 3 phase, 60 cycles. Antenna and Line: For use with concentric or grounded 4-wire transmission lines of 70-300 ohms impedance and with standard antennas. Audio Input Level: Zero level (12.5 m. w.) at 500 ohms for 100% modulation. Tubes (one set): 5-DX Transmitter 3-802, 3-805, 8-866-A, 2-891-R, 1-892-R, 6-872-A, 1-5-Z-3, 2-1603, 2-807, 4-845, 1-83-V; 5-DX Control Console 1-1603, 4-76, 2-6L6G, 1-5Z3, 1-6A6, 2-84.

MECHANICAL SPECIFICATIONS

Transmitter Unit: 115" wide x 84 $\frac{1}{8}$ " high x 27" deep. Weight: 4,170 lbs. Power Panel: 33" wide x 84 $\frac{1}{8}$ " high x 36" deep. Weight: 850 lbs. Filter Rack: 33" wide x 49 $\frac{1}{2}$ " high x 26" deep. Weight: 1,375 lbs. Modulation Transformer and Reactor Unit: 68" wide x 28" high x 24" deep. Weight: 2,100 lbs. Plate Transformer: 39" wide x 24" deep x 46" high. Weight: 990 lbs. Antenna Coupling Unit: 30" wide x 40" high x 22 $\frac{1}{2}$ " deep.

De Luxe 50,000 Watt Transmitter

Type 50-D . . . A De Luxe High Fidelity Transmitting Equipment For Clear Channel Stations

THE TYPE 50-D Transmitter is properly considered an outstanding model in the line of deluxe broadcast transmitters. Despite its relatively large power—which requires certain special types of construction—it is built-up from the low-powered units exactly the same way as are the transmitters in the lower power classifications. It begins, as do those others, with the Type 250-D Exciter—in fact, the low-power stages are nothing else than the Type 5-D Transmitter complete, and existing Type 5-D installations may be increased simply by the addition of the necessary high-power equipment. Because of the problems particular to the construction of a transmitter of this type, it has been found that appearance, as well as accessibility and convenience, are increased by the use of a special type of housing. This consists essentially of a panel-type enclosure,—which is supplied as a separate unit. This arrangement, which has been called the “unified front” method of assembly, allows the units of the transmitter to be mounted in various ways, such that an arrangement can be found best suited for each individual station. As will be noted from the illustration below, the

indicating instruments are mounted on the enclosure, together with such other devices and controls as are required for routine operation. Most controls, however, are located behind access doors, where they are protected from inadvertent manipulation. The whole enclosure is styled in a modern manner with panels and coloring which give a symbolic and attractive appearance.

As before mentioned, the Type 50-D Transmitter consists of the Type 5-D Transmitter followed by a high-power amplifier with its associated rectifier and control equipment. The power amplifier uses two RCA-898 water-cooled tubes in a Class B-C circuit. The two tubes are furnished with separate output circuits and with separate heavy-duty bias rectifiers. One tube is adjusted so that it operates essentially Class C and provides the normal carrier output—that is 50,000 watts. The other operates Class B and comes into operation only on positive modulation peaks. Thus the two tubes co-operate to produce the 200 KW required for positive 100% modulation peaks. The result of this method of operation is to greatly improve the overall efficiency of the output stage, and to

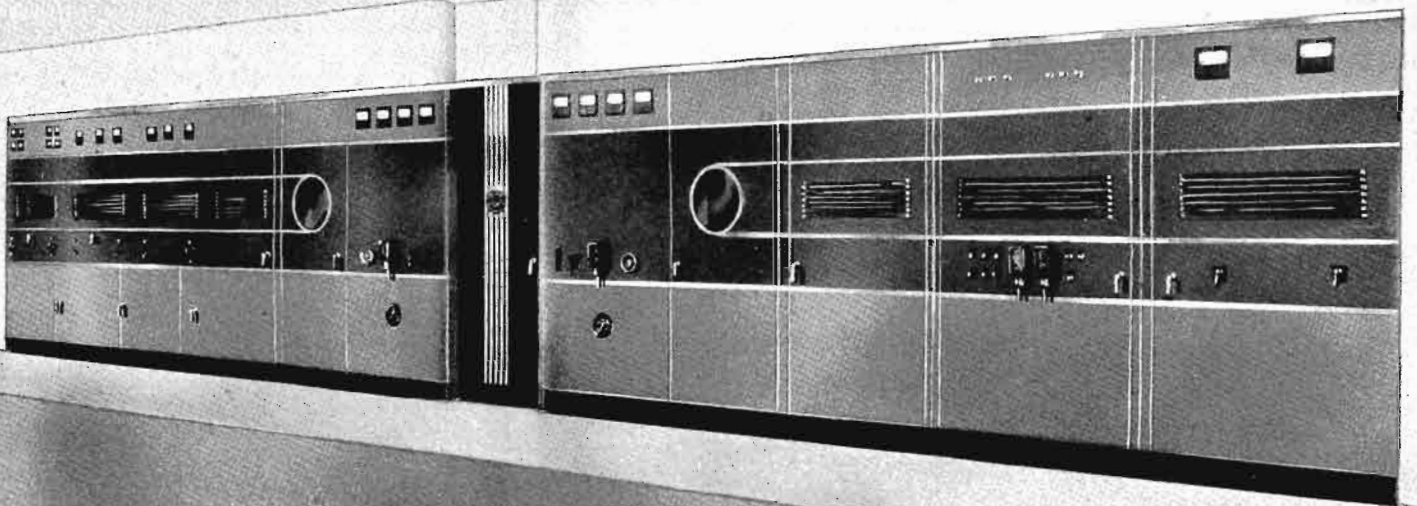

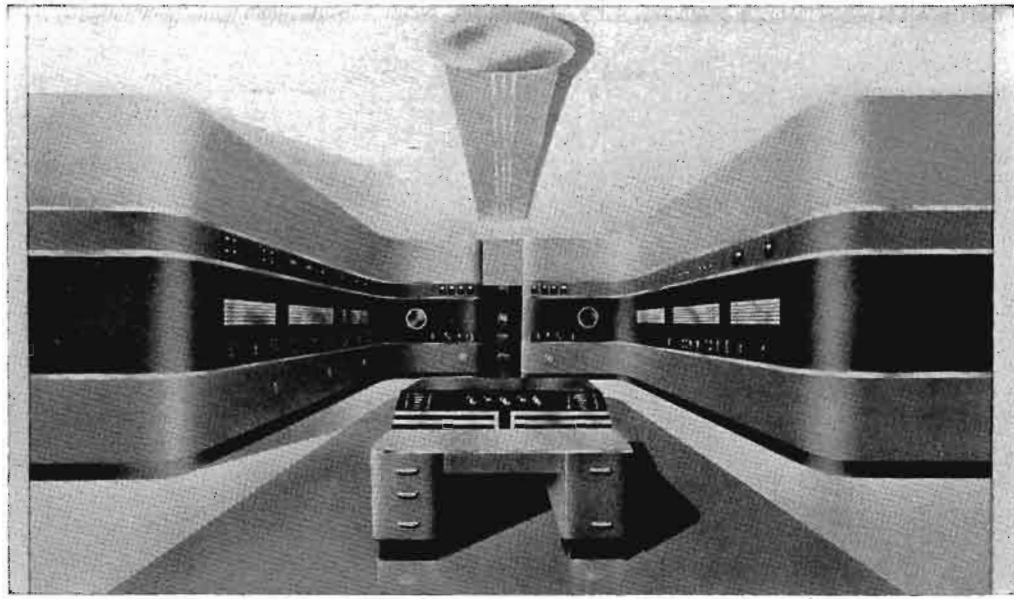

make possible a saving in power consumption of approximately half (as compared to normal linear amplifier operation). The main power rectifier, supplying 18,000 volts for operation of the RCA-898 amplifiers, includes mountings for seven RCA-857-B mercury vapor rectifier tubes. Six of these form a standard three-phase full-wave rectifier, while the additional tube occupies a warm-up position where it is ready for instant service and may be switched into service. Each of the bias rectifiers uses two RCA-872-A's, and there is a feedback rectifier using four RCA-836's in an especially designed circuit. Many of the components making up the power and distribution circuits of this transmitter are of special design—with the result that operating convenience and reliability are very much greater than in previous transmitters of this size. The control circuits have been similarly improved, and many new features added. In addition to centralization of control and distribution circuit components, there is provided a supervisory control console on which are mounted all of the main controls of the transmitter, space for various monitors and various new convenience features—including clocks which automatically note the time of any failure,—and the time in minutes and seconds during which the transmitter is off the air.

The transmission fidelity obtained in the 50-D Transmitter is of the same unusual order as that of the lower-powered units of this line. Distortion is less than 3% RMS from 50 to 7,500 cycles, and from zero to 95% modulation. The frequency response characteristic is flat within 1 db. from 30 to 10,000 cycles, when measured at input voltages corresponding to 60% modulation. Background noise and hum level is more than 60 db. below 100% modulation, unweighted measurement. Radio frequency harmonics are such that the field intensity at one-mile will be at least 70 db. below the fundamental.

SPECIFICATIONS

Rated Power: 50,000 watts. R. F. Range: 550 to 1600 kilocycles. Frequency Stability: better than ± 10 cycles. R. F. Harmonics: 70 db. below fundamental. Audio Input Required: 0 db. for 100% modulation. Frequency Response: within 1 db. from 30 to 10,000 cycles. Audio Distortion: less than 3% RMS from 50 to 7500 cycles. Background volts, three-phase 60 cycles, 137 KW. Weight: packed, approx. 48,000 lbs.

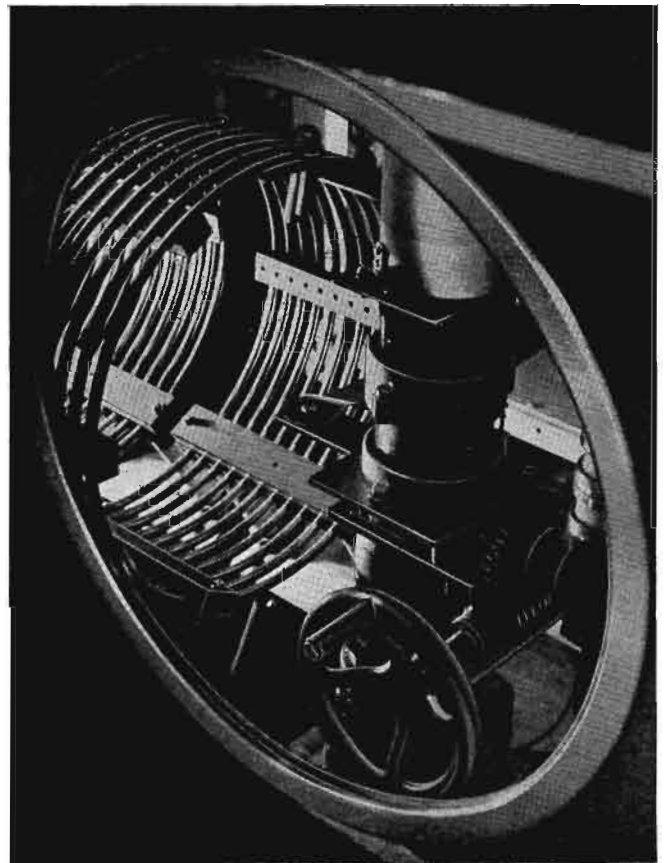



Standard Line **TRANSMITTERS**

DESIGNED for high fidelity and economical service at lower initial prices, the RCA Standard Line Transmitters makes it possible for stations to purchase RCA equipment at new low costs. These transmitters have been built with the conventional frame and shelf construction which is somewhat less expensive than the vertical chassis used on the Deluxe apparatus. In addition, the transmitters have been simplified without, however, omitting anything needed for reliable operation. The styling is modern and pleasing but not elaborate. In this way the selling price of these transmitters has been kept to the minimum level for high quality equipment.

The performance of the Standard Line transmitters compares favorably with equipment selling for much higher prices. Frequency response, hum level and distortion are well within the high fidelity limits. Operating costs are unusually low because of the low power drain resulting from high efficiency circuits. The low cost of the tube complements also contributes to economy of operation.

Components have been carefully selected for performance and reliability. Insulation materials are of the best and only high grade resistors and condensers are employed.

In addition, the Standard Line transmitters receive the same careful test as other RCA transmitters and are carried through the same rigorous design process. Low temperature V-cut crystals are used in the 250-G and 1-G equipment in a circuit designed to minimize frequency drift. Modulation transformers are specially built to specification for low distortion and reliability.

For economical, high fidelity broadcast service, RCA offers its Standard Line transmitters with all of the advantages of carefully designed and tested factory built equipment.

Standard 100/250 Watt Transmitter

Type 100-G for 100 Watts . . . Type 250-G for 100/250 Watts

*A High-Fidelity Simplified-Design Unit Particularly Adapted
to Small Station Requirements*

THE TYPE 100-G/250-G Transmitter is designed to enable small stations to combine high-fidelity transmission with operating economy. It is startlingly simplified in design, low in first cost and extremely economical to operate—but does not yield an inch either in convenience, or in reliability, or in performance, to the finest high-powered transmitters. By a simple change of tubes the same unit operates either as a 100 watt transmitter (specified as the Type 100-G) or a 100/250 watt, or 250 watt transmitter (specified as the Type 250-G).

The modern design and attractive appearance of this transmitter can be seen. While markedly simplified, the general arrangement is unusually convenient and follows the lines of accepted engineering practice. The transmitter is completely self-contained and is housed in a $68\frac{3}{16}$ " by $28\frac{1}{2}$ " by $20\frac{5}{8}$ " copper-plated steel frame of extremely-rugged construction. Interlocked rear doors provide easy access to all parts. The whole unit is finished in two-tone lacquer—light grey for the panel, darker grey for the trimming—and presents a harmonizing and attractive appearance, whether installed at the studio or at a remote point.

Carrier frequency is controlled by a crystal of the low-temperature-coefficient type. Since the coefficient of these crystals is extremely low, a simplified heater chamber of the plug-in type can be used—and, at the same time, better frequency stability obtained. An RCA-802 is used in a new circuit as an oscillator, an RCA-802 as a buffer amplifier. When the transmitter is operated as the Type 100-G the intermediate amplifier consists of a single RCA-838 and the final amplifier of a pair of RCA-838's push-pull. As the 250-G the intermediate uses an RCA-805 and the final a pair of RCA-805's push-pull. The audio system,—which is designed to provide 100% modulation with —16 db. input, obviating the need for a line amplifier,—consists of an RCA-53 as a first stage, four RCA-2A3's push-pull, Class A, as a driver stage, and either two RCA-838's, or two RCA-805's operating as Class B modulators and furnishing the audio power required to modulate the last radio stage. Output circuits are provided for coupling the transmitter to any average antenna or to an open or concentric type line.

A feature of the Type 100G/250G Transmitter which is particularly convenient for small station installation, is that it operates from a single-phase, 105/125 volt, 50/60 cycle power supply. Time-delay and overload relays, as well as the usual plate and filament switches, are provided in the control circuit, so that starting is automatically sequenced and the equipment is fully protected against failure during operation.

SPECIFICATIONS

Rated Power: of 100-G, 100 watts; of 250-G, 250 watts. R. F. Range: 550 to 1600 kilocycles. Frequency Stability: better than ± 10 cycles. R. F. Harmonics: .05% or less. Audio Input Required: —6 VU (—16 db.*) for 100% modulation, —12 VU (—22 db.*) for average program. Frequency Response: within ± 1.5 db. from 30 to 10,000 cycles. Audio Distortion: less than 4% RMS from 100 to 5000 cycles. Background Noise Level: —60 db. (unweighted). Power Required: 105/125 v. 50/60 cycles, single-phase, 1100 watts as 100-G, 1630 watts as 250-G. Dimensions: $68\frac{3}{16}$ " high, $28\frac{1}{2}$ " wide, $20\frac{5}{8}$ " deep. Weight: 900 lb. (net), 1160 lbs. (packed). Tubes: For 250 watts—2-802, 5-805, 1-53, 4-2A3, 1-83, 4-866-A. For 100 watts—2-802, 5-838, 1-53, 4-2A3, 1-83, 4-866-A.

* Zero db. = $12\frac{1}{2}$ milliwatts.

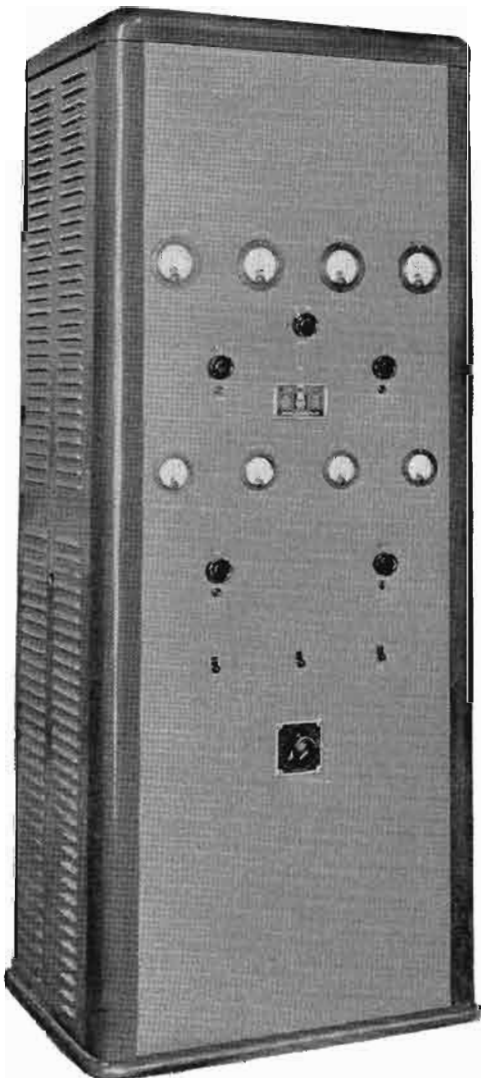

Standard 1000 Watt Transmitter

Type 1-G . . . A Simplified-Type High-Fidelity Transmitter for Medium Power Broadcast

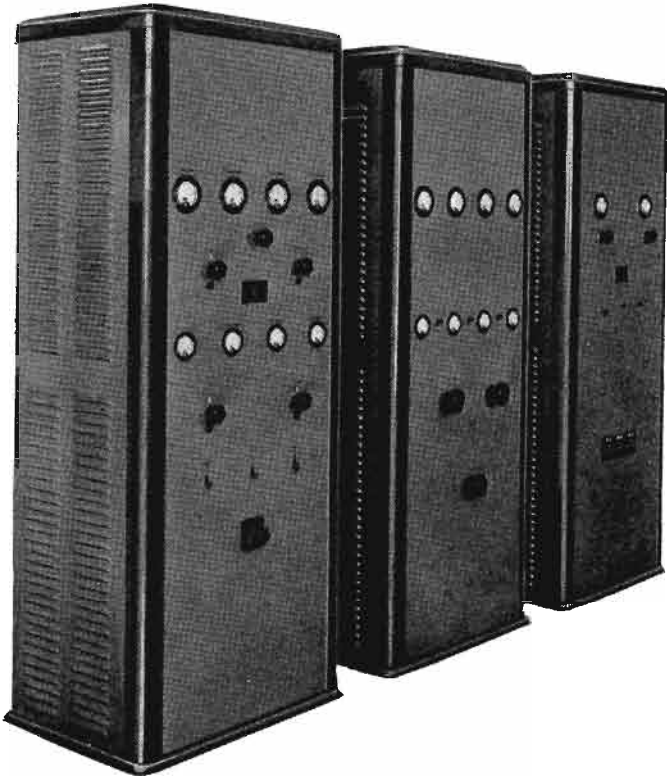

THE TYPE 1-G Transmitter, like the 250-G Transmitter, is an equipment designed to provide stations with high-fidelity, low cost transmission. Primarily this has been accomplished by eliminating the expense of the various extra convenience, construction, and appearance features of the deluxe transmitters. By so doing it has been possible to build a transmitter which, while of extremely simplified design, is nevertheless, capable of performance closely approaching that of the deluxe units, and in every respect as good as will ever be needed in equipment not intended for future expansion.

The Type 1-G Transmitter consists of three units; an exciter unit, a power amplifier unit and a modulator-rectifier unit. The exciter unit is identical to the Type 250-G Transmitter with the exception of a minor change in the audio output system. Essentially this change consists of disconnecting the modulation transformer, modifying the interstage transformer connections—and substituting RCA-845's in the last audio stage of the exciter unit. These then serve as Class A drivers for the RCA-833's in the high-power modulator. The latter, operating Class B, modulate

the r-f output of the two RCA-833's which make up the added power amplifier stage. R-F excitation for these is, of course, furnished by the RCA-805's in the output stage of the exciter unit. Plate voltage for the RCA-833 modulators and amplifiers is furnished by a single-phase full-wave rectifier using four RCA-872 mercury vapor rectifier tubes. This main rectifier, as well as the bias rectifier which uses two RCA-866's, are located in the unit with the modulator tubes.

The control and power circuits of the Type 1-G Transmitter are so designed as to provide all of the accepted features of modern practice, including automatic starting, time delays for proper sequencing, full protection against overloads, and interlocking in high voltage circuits. Monitoring is provided for by three sets of terminals—for modulation, frequency and aural monitors, respectively. Output circuits provide for feeding an antenna directly, through an open-type or concentric-type transmission line. The transmitter is normally supplied for operation at 1000 or 500 watts. However, where split-power operation is required a special power-change panel can be provided which is easily installed and will allow operation at 250/1000 watts, or 500/1000 watts.

As will be seen from the illustration above, the amplifier and modulator units match the exciter unit in appearance and construction. The cabinets are, in fact, identical, while the controls and meters on the three units are so arranged as to provide a pleasing and symmetrical appearance. Full size rear doors provide easy access to tubes and other parts. Properly installed this equipment presents a trim and businesslike appearance and provides fidelity considerably in advance of present day standards.

SPECIFICATIONS

Rated Power: 1000 watts. R. F. Range: 550 to 1600 kilocycles. Frequency Stability: Better than ± 10 cycles. R. F. Harmonics: .05% or less. Audio Input Required: —6 VU (—16 db.*) for 100% modulation, —12 VU (—22 db.*) for average program. Frequency Response: within ± 2 db. from 30 to 10,000 cycles. Audio Distortion: less than 4% RMS from 100 to 5000 cycles. Background Noise Level: —60 db. (unweighted). Power Required: 230 volts, 50/60 cycles, single phase, 4.7 KW. Dimensions: three units each 68" x 28" x 20". Weight: 3000 lb. total. Tubes: 2-802, 3-805, 4-833, 1-53, 2-866A, 4-2A3, 2-845, 4-872, 2-866, 1-83.

* Zero db. = 12½ milliwatts.

Mobile U. H. F. Relay Transmitter

Type ET-4315 . . . A Crystal-Controlled High-Quality Transmitter Especially Designed for Broadcast Pickups

THE TYPE ET-4315 Mobile Transmitter is a low-power transmitter which makes possible broadcasts direct from a moving car, or from points remote from land lines. Taking its power entirely from a single 6-volt storage battery, it may be placed in a car, truck, boat or plane—in fact, practically anywhere—and, within a fairly extended range, will transmit the desired programs back to the studios, or main transmitter, where they are picked up on a receiver and broadcast in the usual manner. Since it operates in the ultra-high frequency band (30-42 MC) the necessary antenna installations are very simple and many of the difficulties formerly encountered are avoided.

The ET-4315 equipment consists of three units; transmitter, dynamotor and control unit. These are connected by cables and plugs, allowing flexible arrangement. The cables and plugs, as well as an antenna kit, are furnished. The transmitter unit and the dynamotor are fitted with rubber mountings to absorb shocks in mobile use.

Frequency of the transmitter is controlled by a V-cut crystal ground to one-fourth the operating frequency. The R-F tube line-up consists of an RCA-1610 oscillator, an RCA-1610 buffer, an RCA-1608 intermediate, and an RCA-1608 final amplifier. The audio tube lineup consists of an RCA-46 input stage driving a pair of RCA-46's as high-level modulators. This circuit, of course, presupposes use of a remote pickup amplifier (of standard type), the input required being approximately zero level.

The carrier power output of the Type ET-4315 Transmitter is 15 watts—which is sufficient for all ordinary requirements and, correctly used, will permit as extended a range as is practical in a battery-operated equipment. The audio characteristics are such as to provide fidelity fully as good as can be utilized on remote pickups. The

Type ET-4315 Transmitter is a high-quality equipment, and should not be confused with short-cut designs in which neither quality nor stability receive much consideration.

Where desired, a mobile receiver (Type MI-7802X) or a fixed a-c operated receiver (Type MI-7803X) can be furnished for use with the Type ET-4315 Transmitter.

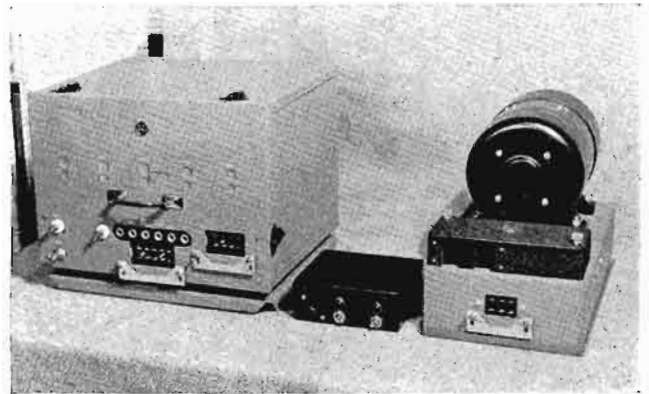

SPECIFICATIONS

Rated Power: 15 watts. R. F. Range: 30 to 42 MC. Frequency Stability: better than .02%. Audio Input Required: 0 db. for 100% modulation. Frequency Response: within ± 1 db. from 70 to 7000 cycles. Audio Distortion: less than 7% RMS from 70 to 7000 cycles for 100% modulation. Background Noise Level: -50 db. Power Required: 6 volts, 35 amperes. Dimensions: of transmitter 15" x 12 $\frac{1}{2}$ " x 11 $\frac{1}{4}$ ", weight 60 lbs.; of dynamotor 13 $\frac{1}{2}$ " x 7 $\frac{3}{4}$ " x 9 $\frac{5}{8}$ ", weight 33 lb.; of control box 4 $\frac{1}{2}$ " x 5 $\frac{1}{4}$ " x 2", weight 5 lb.

Construction Permit Application Data

(See following page.)

IN FILING applications for broadcasting construction permits (Form 301) on RCA broadcast transmitters, it is unnecessary to fill in all of the technical details referring to the transmitter since the information has been filed in Washington with the Federal Communications Commission at the time of approval of the equipment. It is only necessary to place beside each numbered question which refers to transmitter technical data the phrase "Information on file with F.C.C.". The type number of the equipment and the manufacturer's name—RCA Manufacturing Company, Inc.—should be filled in question 21. It should be noted that different power requirements call for differing type numbers as follows:

100-G 100 watts	100-H 100 watts
250-G 250 or 250/100 watts	250-D 250 or 250/100 watts
1-G 1000 watts or 500 watts, also 1000/500 or 1000/ 250 watts	1-E 1000 or 500 watts 5-D 5 or 5/1 KW 5-DX 5 or 5/1 KW

Other transmitters will require full technical data to be submitted and this information can be obtained from district offices. Applicants should not omit the data on antennas nor on necessary monitors. For convenience, the following are the type numbers and approval numbers on RCA equipment:

Type 66-A Modulation Monitor—1552
Type 66-B Modulation Monitor—1553
Type EX-4180 Frequency Monitor—1454
Type 681-A G.R. Frequency Monitor—1452

Frequency Measuring Service

Checks on the accuracy of frequency monitors or on the settings of crystals in transmitters may be made by taking advantage of the RCA Communications Frequency Measuring Service. Measuring stations with extensive facilities are located on the East Coast and on the West Coast. Checks may be made periodically or individually, as required.

17. Description of transmitting apparatus proposed to be installed—
- (a) Make RCA MANUFACTURING COMPANY, INC. Type no. 250-D
- (b) Oscillator: Type of circuit ON FILE Number, manufacturer's name, and type of tubes ON FILE Plate voltage ON FILE
- (c) List buffer and intermediate power amplifier stages, by number and type of tubes in each stage ON FILE Normal night operation ON FILE
- (d) Last radio stage: Number, manufacturer's name, and type of tubes ON FILE Normal night operation ON FILE
- for power requested: Plate current, per tube ON FILE Plate voltage ON FILE
- If greater day power than night power is requested, specify the following:
- Normal day operation: Plate current, per tube ON FILE Plate voltage ON FILE
- Describe fully the proposed method and procedure of reducing power at sunset ON FILE
- (e) Modulator or last audio stage: Number, manufacturer's name, and type of tubes and how operated (Class "A", "A Prime", or "B") ON FILE Plate voltage ON FILE
- (f) Which radio stage is modulated? ON FILE Plate voltage ON FILE
- (g) What system of modulation is employed (high level, low level, grid bias in last radio stage, etc.)? ON FILE
- (h) If low-level modulation is employed, give for modulated radio stage: Number and type of tubes ON FILE Plate current, per tube ON FILE Plate voltage ON FILE
- (i) The transmitter is designed for what maximum percentage of satisfactory modulation? ON FILE
- (j) State name and type number of modulation monitor ON FILE
- (k) Give Federal Communications Commission approval number (FILL IN THIS NUMBER)
- (l) Specify manufacturer's name, type, number, and full scale reading of the following meters:
- (1) In last radio stage: ON FILE
- Plate voltmeter ON FILE
- Plate ammeter ON FILE
- (2) Antenna ammeter ON FILE
- (m) Describe the plate power supply for last stage ON FILE Voltage ON FILE
- (n) Maximum carrier power output of transmitter for satisfactory operation is ON FILE watts.
- (o) Maximum rated carrier power of transmitter as determined by orders of the Federal Communications Commission is ON FILE watts.
18. Description of automatic frequency control equipment:
- (a) Make RCA MANUFACTURING COMPANY, INC. Type No. ON FILE
- (b) If composite, give manufacturer's name, type of cut, and temperature coefficient in cycles per degree centigrade of the quartz crystal ON FILE
- (c) By whom will unit be calibrated? ON FILE
- Calibrated frequency: (FILL IN) kilocycles at ON FILE degrees centigrade.
- Proposed operating frequency: (FILL IN) kilocycles. (Give exact figure, correct to third decimal place at ON FILE degrees centigrade.)
- (d) State guaranteed accuracy of the calibration: ON FILE cycles.

- (e) State number of frequency control oscillators which will be maintained constantly at correct operating temperature and frequency in heat-controlled chambers ON FILE
- (f) Is provision made for instantaneous connection of spare frequency control units? ON FILE
- (g) Manufacturer's name and type of automatic temperature control: ON FILE
- (h) State within what limit automatic temperature control will hold the temperature: ON FILE degrees centigrade. ON FILE cycles per degree
- (i) State temperature coefficient of the frequency control units: ON FILE
- (j) Is temperature coefficient positive or negative? ON FILE
- (k) State manufacturer's name and rated accuracy of: Thermostat ON FILE
- Thermometer ON FILE
- (l) Attach the circuit diagram of automatic temperature control system if not already on file with the Commission. ON FILE
- (m) Attach a sketch or drawing of the automatic temperature control chamber, if not already on file with the Commission. ON FILE
- (n) Describe checking means used for determining if transmitter retains assigned frequency (FILL IN INFORMATION REGARDING FREQUENCY CHECKING SERVICE.)
- (o) State name and type number of separate frequency monitor (FILL IN INFORMATION.)
- (p) Give Federal Communications Commission approval number (FILL IN NUMBER.)
19. Applicant represents ~~that there has been heretofore filed with the Commission, an accurate schematic diagram of the fundamental radio and audio circuits of the transmitter proposed, including antenna and ground or counterpoise connections, antenna feed system, and that it indicates the type of tubes.~~ ON FILE
- (This should be a blueprint or ink drawing, and, if possible, the size of this application, and attached here.)

*Application for Broadcast Station Construction
Permit or Modification Thereof*

Abstract of FCC form No. 301

(Use for standard broadcast transmitters only)

Typical technical information on the RCA 250-D transmitter

TRANSMITTER ACCESSORIES

MI-7113-A LINE VOLTAGE CONTROL UNIT

THE MI-7113-A line voltage control unit is used with low power broadcast transmitters to maintain the line voltage constant. It is manually controlled and consists of a "TRANSTAT" unit in a steel box with a control knob projecting through the top. A flush mounting line voltmeter mounted near the control knob indicates the regulated line voltage. It may be used with the following RCA transmitters: 100-E, 100-F, 250-D, 100-G, 250-G.

The rating of the unit is:

Input line voltage: 100 to 130 volts, 50/60 cycles
 Output load voltage: 115 volts
 Output load current: 19.5 amperes maximum continuous
 Output power: 2.24 KVA.

Dimensions: 12 $\frac{3}{8}$ " x 6 $\frac{1}{8}$ " x 8 $\frac{1}{2}$ "

TYPE AZ-4293 ANTENNA TUNING UNIT, 1 KW

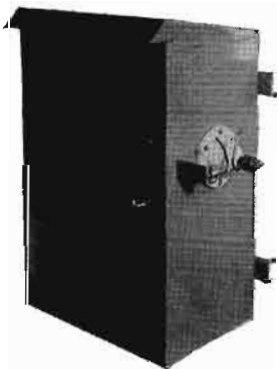

THE MI-7423, Type AZ-4293 Antenna Tuning Unit provides for terminating a transmission line, and matching the line of a broadcast transmitter to the antenna radiator. It is designed to match a transmission line having an impedance of 70 to 350 ohms, one side of which is grounded, to an antenna having a reactance of plus 200 ohms to minus 200 ohms and a resistance of from 20 to 200 ohms.

It consists of a number of tuning elements housed in a weather-proof metal box and is intended for installation on wooden posts, a wooden platform or a steel cradle. An opening is provided in the bottom of the housing for entrance of a concentric tube transmission line, but the unit may also be used with an open wire type of line by a change in the entrance bushings.

Electrically, the unit consists of a low-pass impedance-matching filter using a "T" type network. Adjustments of the line inductance and the antenna loading inductance are made by a selection of taps on these two items. The shunt branch of the network consists of Faradon capacitors. The number and value of these capacitors will vary with the resistance and reactance of the antenna, the operating

frequency, and the impedance of the transmission line, which electrical values—or a description of the line and antenna—must be furnished in order that the proper Faradon capacitor values may be selected for the particular installation in question. A switch is provided for shorting the antenna ammeter when readings are not being taken. The antenna ammeter is a Weston Model 425 with a bakelite case. The unit has been designed for use with the following transmitters: 100-H, 250-D, 100-G, 250-G, 1-G, 1-E.

Dimensions: 30" x 22" x 16 $\frac{3}{8}$ "

TYPE 92-A ANTENNA LIGHTING CHOKE COIL

BROADCAST transmitter installations where the tower itself forms the antenna, must be provided with special transformers or radio frequency choke coils to feed power to the lighting circuits on the tower. The Type 92-A Antenna Lighting Choke consists of a double winding on a suitable form. Its electrical characteristics are such that it has low impedance to the commercial lighting frequencies and high impedance to the radio frequencies in the broadcast range. It therefore provides a means for supplying energy to the tower lighting circuits and at the same time prevents any appreciable loss of r-f energy supplied to the tower by the radio transmitter.

The coil windings are coated with an insulating varnish which binds the turns together and prevents moisture absorption. This coil, however, must be protected from the weather by providing a mounting for it within some weather proof enclosure. Such an enclosure or housing is not provided with the unit.

The electrical characteristics are:
 Maximum current—18 amperes (continuous 50/60 cycles)
 1000 cycle inductance—540 micro henries (approx.)
 DC resistance (total, both windings)—1.1 ohms (approx.)

The natural resonant frequency of the coil is well removed from any frequency within the broadcast band. Its characteristics therefore are such that it presents a very high impedance at all broadcast frequencies.

Two MI-7112, Type 92-A Antenna Lighting Choke Coils may be used in parallel where the load or circuit requirements exceed the ratings of a single coil. All windings that are not directly connected to the tower or to ground, should be properly by-passed by suitable capacitors, such as RCA Type UC-3006, Case 99, .01 mfd.

Dimensions: Length, 33 $\frac{1}{2}$ " x Diameter 4"

ANTENNA TUNING UNIT

Type 105 . . . MI-7444

THIS line-terminating equipment is distinctly new in design and extremely flexible in application. It may be employed to match antennas of widely divergent characteristics to either a concentric or open-wire transmission line on transmitters up to five- or ten-kilowatt output.

In construction, the Type 105 is not complicated since the circuit elements are reduced to a minimum. All parts are enclosed in a weather-proof metallic housing equipped with a door at the front for ready access to the interior. The antenna ammeter is readable through a circular window in the door, and is protected against lightning surges by means of a short-circuiting switch actuated by the knob on the right-hand side.

Various combinations of inductance, capacitance and tap connections to the transmission line and antenna are available. Such variations are provided in order to satisfy conditions imposed by widely different antenna characteristics and broad frequency coverage. Sufficient wiring is furnished to effect all practicable arrangements. Surplus leads should be removed after a circuit has been selected.

Audio-frequency voltage for program monitoring and rectified current for remote antenna-current indication and transmitter control are available for use if desired. Such

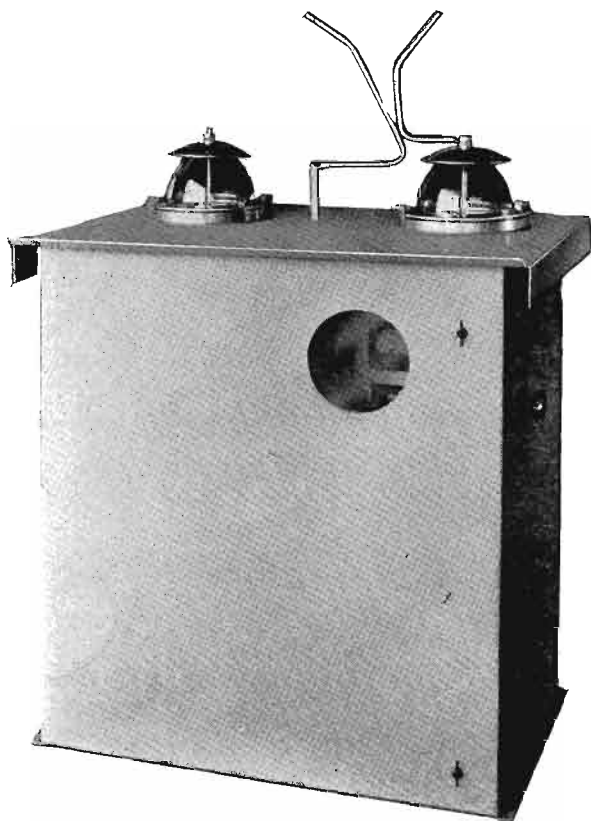
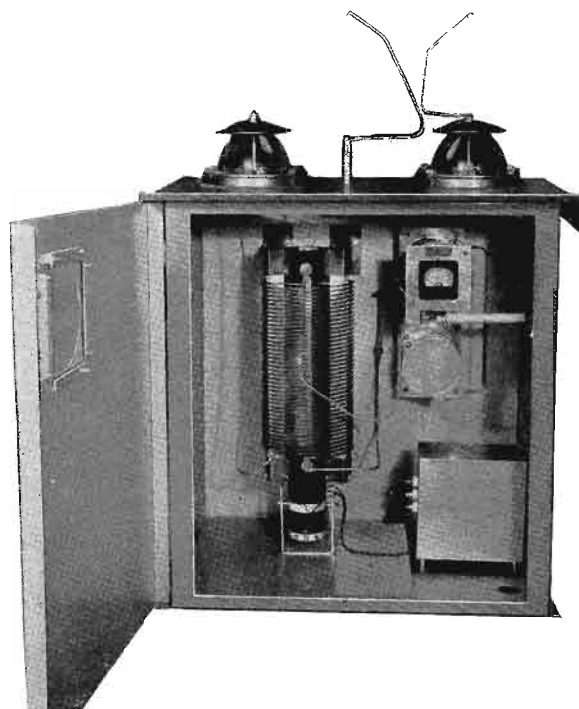

voltage and current are furnished by a monitoring-rectifier unit mounted inside the housing at the bottom.

This unit embodies the necessary equipment to enable the installation of a remote meter for measuring antenna current and also furnishes audio-frequency energy for operation of a monitoring amplifier. The method of remote antenna-current indication as outlined herein has been approved by the Federal Communications Commission. The rectifier utilizes an RCA-83-v tube.

OPERATING LIMITS

Antenna resistance (ohms)	8 to 1100
Antenna reactance (ohms)	+1000 to -1000
Line impedance (ohms)	50 to 300
Carrier frequency (kc)	550 to 1700
Transmitter power (kw)	10 (max.)

Monitoring Rectifier:

Output Impedance: To operate into 20,000-ohm bridging load.

Output Level: (db. approx., including bridging loss)
-20 at 5 kw and -26 at 1 kw.

NOTE—Reference level = 12.5 mw.

Rectified Current: (ma d. c.): 75 (max.) into a maximum of 1000 ohms.

Frequency Characteristic: Substantially flat to 10,000 cycles.

De Luxe

SUPERVISORY CONTROL CONSOLE

Type MI-7237



THE RCA MI-7237 Supervisory Control Console, illustrated in the accompanying photograph, has been styled and designed for use with the RCA Types 5-D, 5-DX and 10-D Broadcast Transmitters. All of the controls and indicating devices necessary for complete operation and observation of the transmitter are grouped conveniently and attractively in the sloping panels of the console turret top. This console also houses an RCA Type 82-A Monitoring Amplifier and an RCA Type 13-D Volume Indicator.

Switches and indicating lamps are provided and connected either in multiple or in series with the corresponding controls on the transmitter, thus permitting complete remote control of the entire transmitting unit and its separate filament, plate and power change circuits. Other switches are conveniently located for controlling the power supplies to the tower lights, speech input rack, monitor amplifier and volume indicator. One key switch is provided to select either of two program lines. This switch, during normal operation, feeds through a local line switch, the master gain control, the station's line repeater, two attenuator pads, and thence to the audio input of the transmitter. When it is desired to make announce-

ments at the transmitter, the local line switch is thrown to the "Local" position, and it is then possible to switch to a local microphone, a turntable or a beat-frequency oscillator. These items feed through an external pre-amplifier, if required, a local gain control and thence into the local line switch.

A remote-indicating antenna ammeter is mounted on the center panel and is actuated by the direct current component from the monitor rectifier in the antenna tuner. The audio component from this monitor rectifier feeds through the RCA 82-A Monitoring Amplifier to an external speaker. A volume indicator and a modulation indicator are mounted on the center panel of the Supervisory Console, near the antenna current indicator.

The MI-7237 Console was designed to furnish an attractive and convenient housing for all those controls and indicating devices which have been proved by experience to be essential, and in addition ample drawer space has been included for station logs, records, instruction books and similar files.

Overall dimensions:

59" long, 44" high, including turret top, 34 $\frac{1}{4}$ " deep

RCA RADIO FACSIMILE SYSTEM

THE RCA Facsimile equipment for broadcast use is a result of more than ten years extensive research and development work on radio photo systems. Designed for use with either ultra high frequency or conventional broadcast transmitters, it may be added at the station in place of an audio channel. The RCA facsimile recorders employ a carbon paper printer which reproduces the material on a roll of white paper at the rate of three feet per hour. The detail of reproduction is 125 lines per inch which is comparable with the number of lines in photo-engraving practice for magazine reproduction. The facsimile material is reproduced in black and white and an excellent half-tone reproduction can be obtained.

By the use of RCA facsimile, graphic material consisting of typed matter, photos, drawings, maps, etc., may be sent over a standard broadcast or u.h.f. transmitter. The RCA system offers the advantage of excellent detail, simplicity of operation, low cost of paper, convenient business letter sized sheets and black and white copy. For experimental facsimile broadcasting, RCA offers the equipment described. More detailed data is available from any district representative.

FAX-1 TRANSMITTING SCANNER EQUIPMENT

THIS apparatus includes everything necessary for coupling into a transmitting station. The apparatus is housed in an attractive console cabinet with the scanner on the top and the amplifier units below. The material to be transmitted is clamped on the drum and scanned, line by line. The output of the photocell is amplified and is arranged to produce about zero level across 500 ohms.



FAX-2A and 2C RECEIVERS

TWO facsimile receivers are available. The FAX-2C is intended for either ultra high or conventional frequency use and includes an 11 tube superheterodyne receiver. The FAX-2A unit is designed for conventional frequency broadcast service and employs an 8 tube chassis. Receivers are arranged for locked tuning at the desired station frequency and are provided with a special automatic volume control, thus assuring satisfactory reception.

The recorder unit is located in the top section of the cabinet. Paper feeds through the front of the cabinet. A roll of paper and carbon paper sufficient for about 115 hours of service may be contained in the recorder.

An electric time switch is included which turns the receiver on and off according to a preset schedule.



RCA TELEVISION EQUIPMENT

AS a result of RCA's extensive research development and field test in all branches of television, RCA's wide experience in building both television transmitters and receivers, as well as actual television transmission conducted both in New York and Camden, N. J., the RCA television apparatus line is probably the most advanced ever offered in a new field. But in addition to extensive facilities for television circuit and tube development which have resulted in apparatus having electrical characteristics considerably superior to those actually required at present, the activities of RCA in the broadcast transmission field have furnished a guide to mechanical design and arrangement for maximum convenience, accessibility and flexibility. In addition, production facilities and manufacture of apparatus by economical methods enable RCA picture apparatus to be sold for prices comparable with equivalent sound broadcasting units, considering the more stringent requirements which must be met. As a result, RCA television apparatus units are obtainable with advanced circuit design, in commercial mechanical layouts and with performance exceeding present requirements in regard to frequency response, noise level and phase displacement. Equipment is available in unit form or in

complete chains for laboratory, experimental or transmission purposes.

COMPLETE SYSTEM

RCA television apparatus includes receivers of several different types, video amplifier and terminal equipment, transmitters, vacuum tubes, measurement apparatus and television field pickup units. It is significant that just as RCA produces a complete line of apparatus for broadcast transmission and reception, so RCA has designed an integrated line of television apparatus, complete even to the test equipment for operation or adjustment. Full information is available to prospective purchasers of any of this equipment although it is not practicable to provide more than a condensed outline of most of the line here. A description of the RCA measurement apparatus for television will be found in a separate section of this catalog and RCA television tubes are listed with other special purpose tubes in the rear of this book. Data on television receivers is available on request.

VIDEO EQUIPMENT

RCA video apparatus, the parallel of the audio apparatus found in



RCA Television Camera.

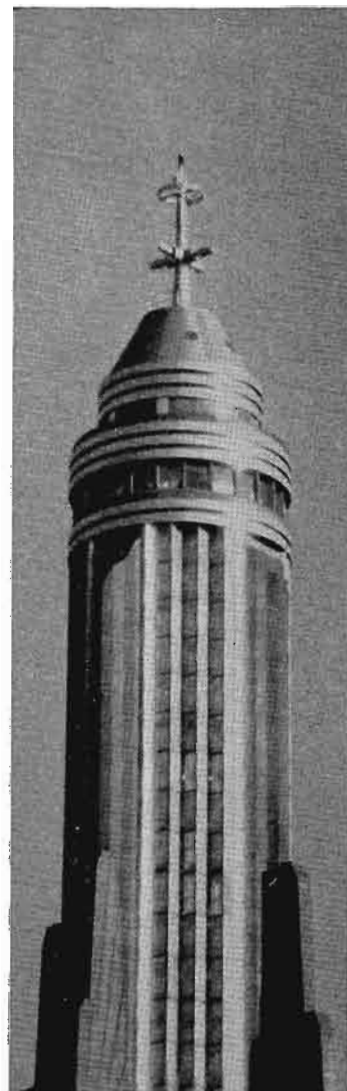

RCA Television Antenna atop Empire State Building.

RCA TELEVISION EQUIPMENT

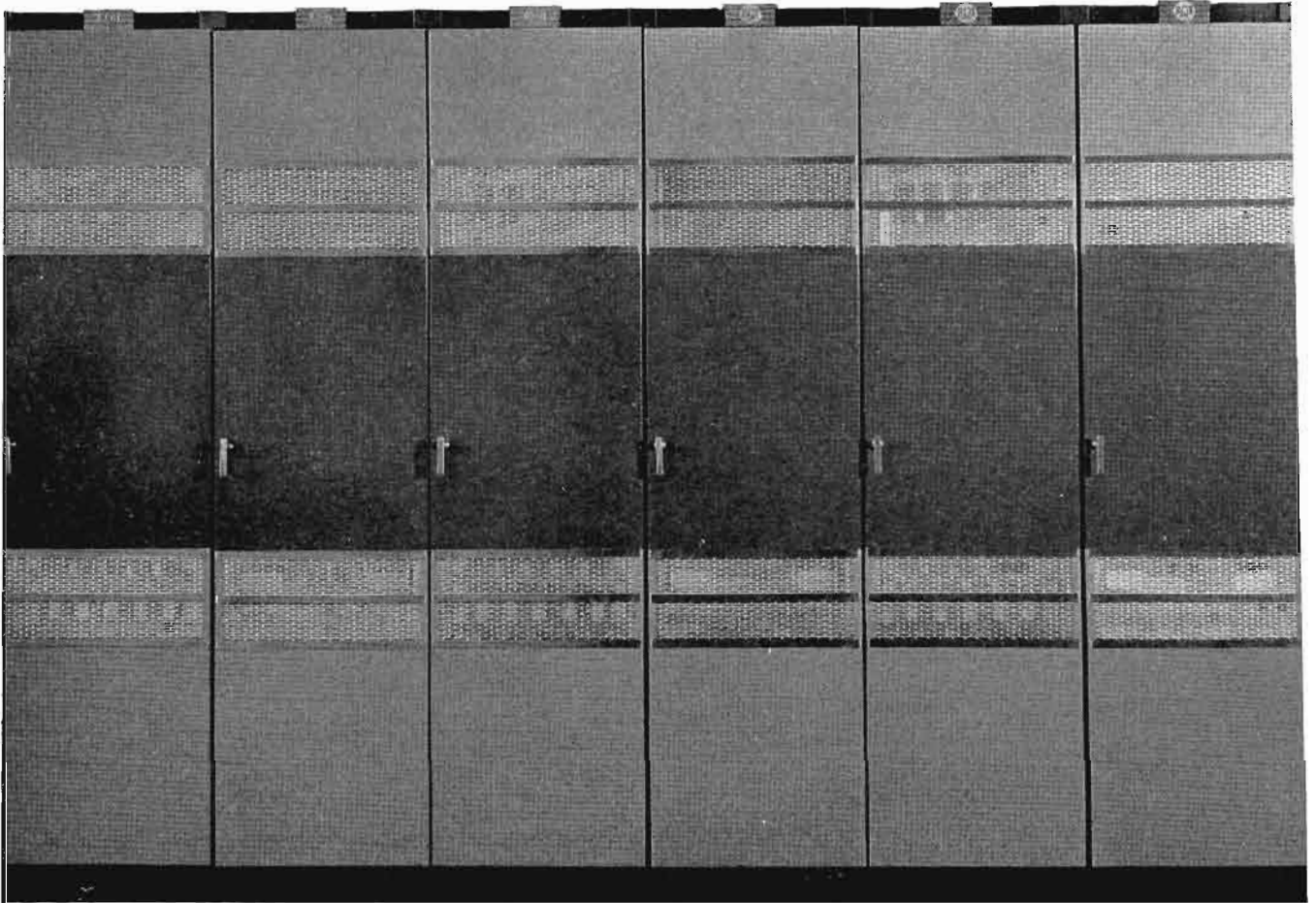

RCA Video Equipment is housed in these racks.

broadcast studios and control rooms, includes studio and film cameras, film projectors, camera apparatus chains, amplifiers, synchronizing generators, monitors and accessory equipment.

The design of the apparatus permits an equipment layout in many ways similar to that used in broadcasting. Each camera, containing a video preamplifier and associated apparatus, requires a "chain" of video equipment, mounted on a rack in the control room and performing the functions of amplification, the supplying of suitable deflection voltages to the Iconoscope, power supply, etc. The output of the camera chain may be switched to common apparatus used with any number of cameras and including a synchronizing generator and line amplifier. Monitors

may be employed for viewing the picture produced by each camera or on the output line. Picture oscillographs having wide frequency response characteristics are employed for setting levels and checking operation.

The RCA video panels are constructed for rack mounting and embody a special mechanical design arranged for accessibility as well as for carrying off heat from components and tubes. This construction, a modification of the vertical chassis design which has proved so popular in RCA broadcast transmitters, provides for the mounting of tubes, condensers and adjustment controls on the front of a dished chassis. On the rear are located the other components and interconnecting wiring. Instead of separate front

RCA TELEVISION EQUIPMENT

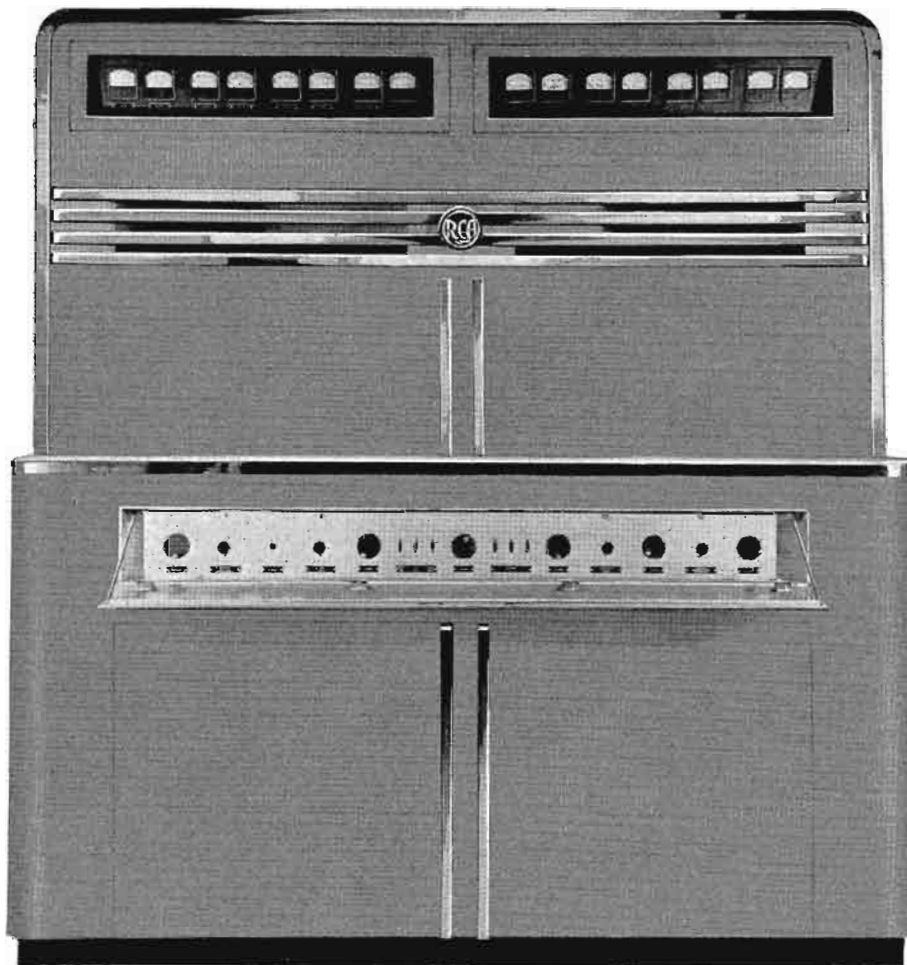

RCA 1 KW. Picture Transmitter Type T-1.

panels, a door the full length of the rack is used. On opening this, all tubes are easily reached and grilles in the door promote good ventilation which is aided by the natural thermal circulation up the rack. The rear door of the cabinet rack affords access to the back of all panels where other components are located. Plate currents of most of the vacuum tubes may be read by plugging a portable meter into a jack and operating a selector switch for the desired tube. Provision is made for checking circuits with an oscillograph by connecting to terminals in the rear.

Operating controls are usually located on a control console which may be designed for any number of camera channels. Remote control of brightness and

gain is effected by means of d. c. circuits. Special coaxial cable terminations are furnished for video circuits on the units. Other apparatus including film projectors, camera stands, alternate lens systems, etc., is also available. Standard RCA broadcast studio equipment may be employed for the sound channel.

RCA video apparatus may be obtained in rack and panel design for any number of camera channels or in simplified cabinet form for use with one camera only.

TRANSMITTER AND SPECIAL APPARATUS

The RCA 1 KW. picture transmitter, Type T-1, is a medium power television transmitter built to commercial standards and including a number of impor-

RCA TELEVISION EQUIPMENT



Television Demonstration Unit Model 510A.

tant circuit developments. This equipment, crystal controlled and a. c. operated, employs tubes designed particularly for this application and is easy to install and to operate. A carrier frequency range of from 45 to 108 mc. is covered with a frequency response good to over 4.5 megacycles. The transmitter employs d. c. coupling between the modulator and power amplifier with special isolation circuits to permit operation of the tube filaments from a. c. Undesirable transient characteristics have been avoided by the use of carefully designed video circuits and novel power supply systems.

The transmitter is mounted in a well styled cabinet and includes an external power supply frame and water cooling unit for the power amplifier tubes.

An external partial sideband suppression filter is available, designed to reduce transmission of the lower sideband without disturbance of the picture. This filter is composed of several sections and is constructed of transmission line of the proper characteristics.

RCA television field pickup equipment for mobile use is under preparation at the time of issuance of this catalog. It allows for picture transmission by special wire line or by radio links to the main television station. Both video apparatus and very high frequency, small size radio transmitter units are included.

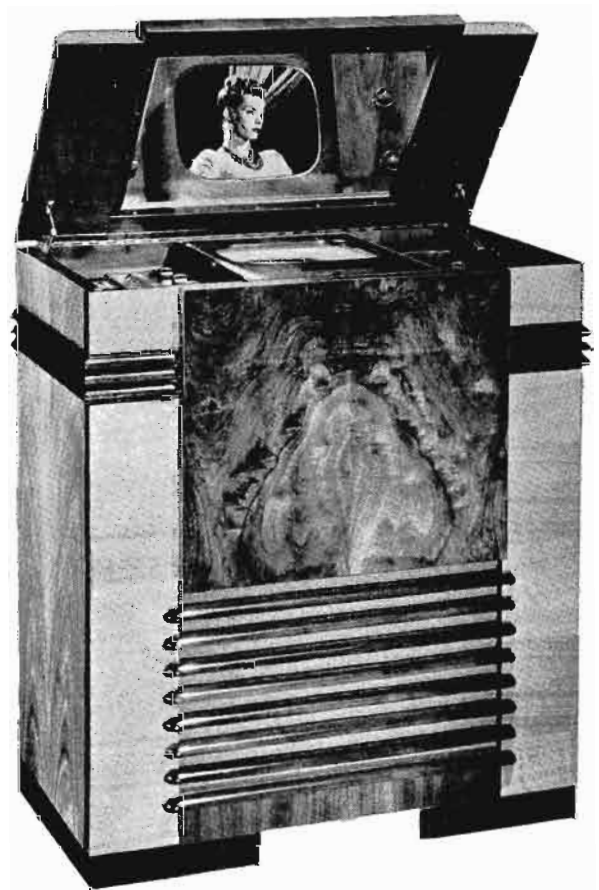

RCA Victor TRK-12 Television Receiver.



MEASURING EQUIPMENT



MEASURING EQUIPMENT

IN this section are described the more popular types of commercial and laboratory equipment built by the RCA Manufacturing Company Inc. RCA measuring equipment has been manufactured for more than ten years; but since it has been functional apparatus, geared to the specific needs of some particular field, it has been presented and described in bulletins for that field.

Although each instrument was originally designed for a particular application, many of these equipments have innumerable other uses. The first section describes units of this type, whose value as general-purpose laboratory instruments is virtually unlimited.

The second part describes several units used to furnish vacuum-tube operating potentials from a primary source of power. This group is referred to collectively as power-supply equipment. Some of the units operate from ordinary 110-volt a-c current, while others are powered by storage batteries and so are highly useful in field testing applications.

The third section deals with audio- and radio-frequency measuring equipments, originally developed for broadcast applications. Included in this group are monitoring devices for continuously indicating frequency deviation, phase shift, percentage of modulation, distortion, and speech-input level. These units are of exceptional quality; and, in addition to the uses already given, they will find numerous others in research work conducted by university and commercial laboratories.

Television measuring equipment is discussed in the fourth section. These equipments have been important tools in the hands of the skilled RCA research engineers who have been instrumental in developing television to its present state of perfection.

In the fifth section are described various units designed primarily for industrial applications, particularly for studies of transient mechanical phenomena, such as pressure variation, vibration, etc.

GENERAL PURPOSE APPARATUS

CATHODE-RAY OSCILLOGRAPHS

One of the most widely used instruments in the radio industry is the cathode-ray oscillograph. It enables the engineer to observe intricate circuit phenomena with a degree of accuracy hitherto unattainable. The enthusiastic acceptance accorded this instrument in recent years has been due to its two outstanding advantages over any of its predecessors: (1) the indicating "pencil," being a beam of electrons, has entirely negligible inertia, permitting faithful reproduction of the wave form of current and voltage transients over an extremely wide range of frequencies; and (2) severe overloads may be applied without injury to the equipment, a feature which is extremely important in experimental work where it is sometimes impossible to predict the magnitude of voltages obtained in trial circuits.

Although practically unlimited in application, some of the more common uses of the cathode-ray oscillograph are: observation of recurrent and transient wave forms, meas-

urement of current and voltage amplitudes, of audio-frequency distortion in amplifiers, hum measurement, checking percentage of modulation in transmitters, determination of unknown frequencies, alignment of radio receivers, and measurement of phase angles.

Moreover, this type of oscillograph has recently assumed a position of importance in many branches of industry other than electrical and radio. An excellent example of this is found in its application to engine-pressure indication, which is treated in a subsequent section.

It is self-evident that the larger the tube, the greater the deflection and accuracy of measurement. For this reason, and because of the wide variety of applications involved, there has been developed a complete line of instruments ranging in size from a small portable unit, equipped with a 1-inch tube, to the large special television oscillograph with a 9-inch tube and weighing nearly 500 pounds.

9" CATHODE-RAY OSCILLOGRAPH Type 304-A

Applications: The Type 304-A Cathode-Ray Oscillograph is admirably well adapted to laboratory applications of all kinds. It has found a wide field of usefulness, also, in industrial fields, being especially valuable in studies of vibrations and internal-combustion engine pressures (see pages 18-20). Other uses include frequency comparisons, speed indications on small high-speed motors, and studies of noises and musical tones. It has innumerable uses in laboratories of colleges and technical schools, industrial testing divisions, and in research and experimental laboratories in almost every field of industry and education, for every application where a large, easily read trace is necessary or desirable.

Description: A laboratory-type cathode-ray oscillograph of modern design, employing the RCA-914 9-inch High-Vacuum Cathode-Ray Tube. Its trace is sharp and brilliant, permitting fast photographic recording of transients. The deflection amplifiers are essentially flat over a frequency-response range of 4 cycles to 100,000 cycles, and will faithfully reproduce square waves as low as 10 cycles in frequency. At the top of the panel are controls for focusing, and for adjusting the brilliancy of the image. Conveniently grouped below are horizontal and vertical centering controls, amplifier gain controls, and controls for synchronizing the sweep with either the wave form being observed or an external timing source.

Features: Two-stage deflection amplifiers with exceptionally wide range; blanking amplifier, a feature unique with this oscillograph, which varies the bias on the grid of the cathode-ray tube to interrupt the oscillographic trace at definite intervals for visual indication of time elapsed over any portion of the trace; opening in side of cabinet for direct connection to deflection plates; electronically regulated power-supply, insuring pattern stability irrespective of line-voltage fluctuations; safety interlock switch which automatically disconnects all power upon removal of instrument from cabinet; shield which protects cathode-ray tube against magnetic interference; distortion-free, shatter-proof glass protecting screen of cathode-ray tube from damage or breakage.



Specifications:

Deflection sensitivity: With amplifier.....	0.02 volt (r.m.s.) per inch
Amplifier response range.....	4-100,000 cycles
Amplifier gain.....	1450
Amplifier input impedance (at 1,000 cycles)	
Push-pull.....	1 megohm
Single-ended.....	0.5 megohm
Timing-axis range.....	4-18,000 cycles
Power supply.....	110-120 volts, 50-60 cycles
Power consumption.....	150 watts
Dimensions.....	height 20", width 12½", depth 24¾"
Weight.....	98 lbs.
Radiotrons	
1 RCA-914, 8 RCA-6C6, 1 RCA-885, 2 RCA-6J7, 1 RCA-6N7G,	
1 RCA-879, 1 RCA-5Z3, 1 RCA-2A3, 1 RCA-874; total 17.	
List Price (complete with tubes).....	

GENERAL PURPOSE APPARATUS

CATHODE-RAY OSCILLOGRAPHS

9" SPECIAL CATHODE-RAY OSCILLOGRAPH Type 305-A

The Type 305-A has been especially developed for television research applications. Its deflection circuits are capable of linear amplification from the lowest audio frequencies up through the video range, and will pass square waves with low distortion from thirty cycles to over one hundred kilocycles. A comprehensive treatment of this oscillograph is given on page 15.

5" STANDARD CATHODE-RAY OSCILLOGRAPH No. 160

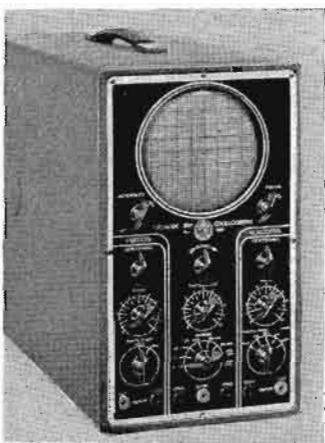

Applications: A modern, general-purpose oscillograph suitable for use in all commercial and educational laboratory work. Deflection amplifiers with exceptional low-frequency response and a very low-frequency timing-axis oscillator adapt this instrument admirably for engine-pressure indication and similar studies.

Description: The No. 160 oscillograph incorporates the recently introduced RCA-1802-P1 (5-inch) Cathode-Ray Tube. Low-distortion amplifiers are used for both vertical and horizontal deflections, two stages being employed in the former to provide extremely high sensitivity. Inputs, with

one side grounded, can be applied direct to either pair of deflecting plates, with no effect on the beam-centering circuits.

Features: New 5-inch cathode-ray tube affording large, clear trace; graduated viewing screen permitting direct measurement of deflection amplitudes; wide-range deflection amplifiers and low-frequency timing-axis oscillator providing unusual accuracy of measurement.

The RCA No. 158 5-Inch Oscillograph, similar to the No. 160, is also available for television-service applications. However, the frequency characteristic of the vertical amplifier of the No. 158 is essentially flat from 5 cycles to 500 kilocycles and is down only 50 percent at 1000 kc. Included with this instrument is a detachable coaxial input cable equipped with a special termination unit providing high input resistance and low capacitance.

Specifications of No. 160:

Deflection sensitivity (with amplifier):	
Vertical.....	0.013 volt (r.m.s.) per inch
Horizontal.....	0.56 volt (r.m.s.) per inch
Amplifier response range:	
Vertical.....	3-50,000 cycles
Horizontal.....	5-100,000 cycles
Amplifier gain.....	vertical 1350; horizontal 31
Amplifier input resistance.....	500,000 ohms
Timing-axis range.....	4-22,000 cycles
Power supply.....	105-125 volts, 50-60 cycles
Power consumption.....	55 watts
Radiotrons	
1 RCA-1802-P1, 3 RCA-6C6, 1 RCA-884, 1 RCA-879, 1 RCA-80	
Dimensions.....	height 14 $\frac{1}{4}$ " , width 8" , depth 24 $\frac{3}{4}$ "
Weight.....	30 lbs.
List Price (complete with tubes).....	

3" SPECIAL CATHODE-RAY OSCILLOGRAPH No. 9641

Applications: The RCA No. 9641 Special Cathode-Ray Oscillograph is of an intermediate size using a 3-inch diameter cathode-ray tube. Many refinements of design have been incorporated in this instrument rendering it extremely well adapted to all general laboratory uses. Yet it is light enough in weight to be readily portable.

This instrument has a very low-frequency timing-axis oscillator which commends it especially for use in engine-pressure measurements, vibration measurements, and similar studies. It is, at the same time, a fine general-purpose equipment and is highly recommended for laboratory and industrial applications of every type.

Description: This oscillograph is a moderate-sized instrument of sturdy metal construction. It uses the standard RCA-906 3-Inch Cathode-Ray Tube and is equipped with wide-range horizontal- and vertical-deflection amplifiers. A special low-frequency timing-axis oscillator has been incorporated in this model, adapting it ideally for industrial and mechanical research applications. The cabinet is attractively finished in gray wrinkle lacquer with a black panel on which all controls are conveniently located. A carrying handle is provided for portability.



Features: Three-inch cathode-ray tube providing a large, easily read trace with sufficient detail for practically every application; convenient arrangement of all controls on front panel for ease of operation; high-fidelity deflection amplifiers and a timing oscillator with extended range, providing exceptional flexibility of operation; jacks on side of cabinet permitting direct connection to deflection plates for observation of d-c phenomena; graduations on the viewing screen facilitating accurate measurement of deflection amplitudes.

Specifications:

Deflection sensitivity: With amplifier.....	0.7 volt (r.m.s.) per inch
Amplifier response range.....	4-90,000 cycles
Amplifier gain.....	40
Timing-axis range.....	4-18,000 cycles
Power supply.....	110-120 volts, 50-60 cycles
Power consumption.....	50 watts
Dimensions.....	height 12 $\frac{1}{4}$ " , width 7 $\frac{1}{4}$ " , depth 17 $\frac{3}{4}$ "
Weight.....	39 lbs.
Radiotrons	
1 RCA-906, 2 RCA-57, 1 RCA-80, 1 RCA-879, 1 RCA-885;	
	total 6
List Price (complete with tubes).....	

GENERAL PURPOSE APPARATUS

CATHODE-RAY OSCILLOGRAPHS

3" STANDARD CATHODE-RAY OSCILLOGRAPH No. 155

Applications: The RCA No. 155 Cathode-Ray Oscillograph has been designed to appeal to the better-qualified service engineer and to meet the requirements of smaller commercial and university laboratories. It is suitable for more exacting work than the strictly portable instruments owing to improved deflection-amplifier characteristics and the wider range of its timing-axis oscillator. Although practically unlimited in application, some of its more common uses include the study of wave shapes, measurement of modulation of transmitters, adjustment of radio receivers and transmitters, and determination of peak voltages.



ray beam. Its sturdily constructed metal cabinet is equipped with convenient snap handle and attractively finished in gray wrinkle lacquer. The control panel is of pleasing modernistic design.

Features: Convenient grouping of all controls on front panel for simplified operation; graduated viewing screen permitting direct measurement of deflection amplitudes; high-fidelity amplifiers and wide-range timing oscillator, insuring accuracy and dependability of results; three-inch cathode-ray tube which provides a large, easily read image with sufficient detail for practically every application.

Specifications:

Deflection sensitivity: With amplifier.....0.5 volt (r.m.s.) per inch
 Amplifier gain.....40
 Timing-axis range.....15-22,000 cycles
 Power supply.....110-120 volts, 50-60 cycles
 Power consumption.....50 watts
 Dimensions.....height 15", width 8", depth 14"
 Weight.....21 lbs.
 Radiotrons...1 RCA-906, 2 RCA-6C6, 2 RCA-80, 1 RCA-884; total 6
 List Price (complete with tubes).....

2" CATHODE-RAY OSCILLOGRAPH No. 151-2

Applications: This oscillograph is well suited for radio service work, including visual alignment of receivers, checking for distortion and hum, and investigation of numerous other circuit characteristics of modern sets.

Description: A compact, inexpensive, portable oscillograph of high quality, built to give dependable service. Uses the RCA-902 (2-inch) Cathode-Ray Tube.

Features: Graduated tilt-mounted screen for easy, rapid measurement of deflection amplitudes; internal saw-tooth oscillator providing linear timing axis.

Specifications:

Deflection sensitivity: With amplifier.....0.5 volt (r.m.s.) per inch
 Amplifier response range.....20-15,000 cycles
 Amplifier gain.....50
 Timing-axis range.....30-10,000 cycles
 Power supply.....110-120 volts, 50-60 cycles
 Power consumption.....30 watts
 Dimensions.....length 13 $\frac{3}{4}$ ", height 9 $\frac{1}{4}$ ", depth 7 $\frac{3}{4}$ "
 Weight.....14 $\frac{1}{2}$ lbs.
 Radiotrons...1 RCA-902, 1 RCA-885, 2 RCA-6C6, 1 RCA-80; total 5
 List Price (complete with tubes).....



1" CATHODE-RAY OSCILLOGRAPH No. 151

Applications: This instrument is designed for service work on radio receivers, and is an excellent visual indicator for aligning the r-f and i-f stages, and determining such characteristics as audio distortion and hum.

Description: A portable instrument of extremely small size and light weight, using the RCA-913 (1-inch) Cathode-Ray Tube.

Features: Linear timing-axis oscillator and convenient front-panel controls insuring ease of operation; graduated viewing screen facilitating measurement of deflection amplitudes.

Specifications:

Deflection sensitivity: With amplifier....1.75 volts (r.m.s.) per inch
 Amplifier response range.....20-15,000 cycles
 Amplifier gain.....50
 Timing-axis range.....30-10,000 cycles
 Power supply.....110-120 volts, 50-60 cycles
 Power consumption.....30 watts
 Dimensions.....length 13 $\frac{3}{4}$ ", height 9 $\frac{1}{4}$ ", depth 7 $\frac{3}{4}$ "
 Weight.....14 $\frac{1}{2}$ lbs.
 Radiotrons...1 RCA-913, 1 RCA-885, 2 RCA-6C6, 1 RCA-80; total 5
 List Price (complete with tubes).....

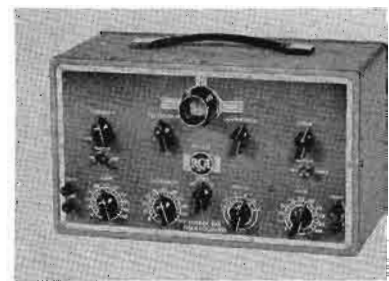

GENERAL PURPOSE APPARATUS

METERS

ULTRA-SENSITIVE D-C METER No. 9819

Applications: The numerous uses of this precision instrument include measurements of electron currents, leakage currents, secondary emission, minute currents in photo-electric cells, electrolysis and corrosion currents and potentials, and galvanic currents and potentials. As a voltmeter, it gives accurate measurements across high-resistance circuits; as a current meter it may replace wall galvanometers or similar sensitive instruments. The instrument is particularly advantageous for resistance measurements since no more than 0.5 volt d.c. is ever applied across the unknown.

Description: This meter is an extremely sensitive portable instrument for accurate measurements of current, voltage, and resistance in d-c circuits of low current values. It consists essentially of a multiplicity of input circuits, a feed-back amplifier, and a meter circuit.

Conversion for the three types of operation is accomplished by an eleven-position selector switch having six positions for current measurements, four for voltage, and one for resistance. A push-button used in conjunction with this switch provides a five-to-one step-up in sensitivity at any switch position. The feedback amplifier permits use of a rugged indicator and makes it impossible to burn out the meter through overload.

Features: Sensitivity greater than that of any portable meter of the pivot or suspension type, the most sensitive range giving a deflection of one scale division (over $\frac{1}{16}$ ") with a current of 0.0004 micro-ampere; stability on all ranges equivalent to that of delicate suspension instruments, with no necessity for critical adjustments; economy effected through employment of standard low-priced batteries.

Specifications:

Current Measurements:

6 scale ranges.....0-0.02 to 0-10,000 micro-amperes
Input resistance.....varies between 50 ohms and 5 megohms over the total current range

Voltage Measurements:

4 scale ranges.....0-0.1 to 0-500 volts
Input resistance.....constant at 5 megohms for all ranges

Resistance Measurements:

2 scale ranges.....0.1-100 megohms; 20-1000 megohms
Less than 0.5 volt d.c. across resistance
Extended range to 200,000 megohms with external 90-v battery

Calibration Accuracy:

Current and voltage scales.....2% of full-scale reading
Resistance scale.....3% of scale length ($3\frac{3}{8}$ ")

Radiotrons.....3 RCA-1B4

Batteries...7 Burgess No. 5540 or equivalent (7.5 volts each)
2 Burgess No. 2 Uni-Cell or equivalent (1.5 volts each)
2 Burgess No. 4 FA or equivalent (1.5 volts each)

Dimensions.....height 13", width 9", depth $8\frac{3}{4}$ "

Weight (with batteries).....20 lbs.

List Price (complete with tubes).....

WIDE-RANGE LOGARITHMIC AUDIO METER Type 302-A

Applications: This instrument, sometimes called a noise meter, is ideal for determination of signal-to-noise ratios in field-intensity measurements. Equipped with a logarithmic scale and a tapped input attenuator, it is usable over an operating range of 85 db, from -25 db (0.044 volt) to +60 db (775 volts) referred to a zero level of 0.001 watt across 600 ohms. Readings, in decibels, are obtained simply by adding algebraically the meter indication and the attenuator setting.

Other applications include checking the response of loudspeakers, receivers, amplifiers, etc. at any desired frequency within its range. Using a microphone and a preamplifier, the instrument becomes an excellent sound-level indicator. Sufficient output is available to operate any 5-ma recorder having a resistance of not over 560 ohms, a jack being provided on the front panel for connections.

Description: The Type 302-A meter is a vacuum-tube voltmeter, whose characteristic is so controlled that the indicating-meter variation is logarithmic. It consists of two audio-frequency amplifier stages followed by a combined diode detector and d-c amplifier. An internal source of calibrating voltage is provided by a neon-tube oscillator, insuring accuracy of measurement within 1.5 db over a frequency range of 60 to 15,000 cycles. Cables are supplied for audio-input and power-supply connections. The instrument is very light in weight, and is contained in a sturdy metal case equipped with a removable hinged cover and a snap-type handle.

Features: Logarithmic indication, which gives an extremely wide voltage range and, at the same time, provides easy reading on a linear decibel scale in conjunction with an input attenuator tapped at even 5-db steps; jack on the front panel providing for connection of a recording milliammeter.

Specifications:

Frequency response..... ± 1 db, 60-15,000 cycles
Accuracy (overall)..... ± 1.5 db
Meter scale..... ± 1 db
Input attenuator..... ± 0.5 db
Sensitivity.....-25 db; zero level = 0.001 watt, 600 ohms
Operating range

Overall...85 db, -25 db (0.044 volt) to +60 db (775 volts)
Meter scale.....40 db (-20 to +20)
Input attenuator.....45 db (-5 to +40)

Input impedance.....500,000 ohms

Power requirements—(see 93-A Power Supply, page 7)

"A".....6 volts, 0.9 ampere (a.c. or d.c.)
"B".....150 volts, 19 ma (no signal)

Radiotrons.....2 RCA-6K7, 1 RCA-6R7, 1 RCA-991. 1 G-10

Dimensions.....height 12", width $9\frac{1}{2}$ ", depth $5\frac{1}{8}$ "

Weight.....9 lbs.

List Price (complete with tubes).....



POWER SUPPLY EQUIPMENT

A-C AND STORAGE-BATTERY TYPES

In this section are described various units designed to furnish plate or filament voltages, or both, for various types of measuring equipment. These units may be divided into two general classes with respect to the intended primary source of power. In some, operation is intended from 110-volt, a-c lines to accommodate non-powered laboratory-type instruments. In others, a storage battery furnishes power which is stepped up by a synchronous vibrator and a transformer for operation of portable-type equipments on location.

Also described are a unit for operating a-c powered instruments from a storage battery and a device for automatically regulating a-c line voltages which are subject to severe fluctuation.

REGULATED POWER UNIT Type 310-A

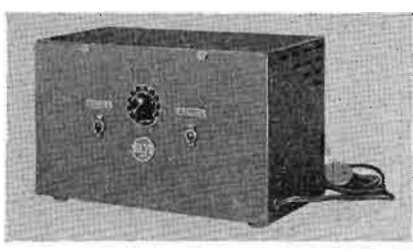

Applications: This equipment supplants the "B" batteries recommended for non-powered laboratory-type instruments.

Description: The Type 310-A is an electronically regulated a-c power unit

using a full-wave rectifier circuit. The output voltage is maintained essentially constant over an extremely wide voltage range by means of a special regulating circuit utilizing four tubes.

Features: Voltage regulation better than that obtained with heavy-duty batteries; special regulating circuit which maintains output essentially constant over wide range of loads and line voltages; well-filtered output, reducing hum content to negligible proportions; control on front of cabinet permitting easy adjustment of output to desired value.

Specifications:

Permissible outputs { (a).....80 ma at 135 to 180 volts
(b).....40 ma at 135 volts, and 20 ma at 90 volts
Higher voltages up to approximately 250 volts at reduced output currents may be obtained as indicated in the chart below.
Output variation.....±1 v. with supply-line variations of ±10 v.
Power supply.....90 to 130 volts, 50-60 cycles
Power consumption.....70 watts
Radiotrons.....1 RCA-80, 1 RCA-2A3, 2 RCA-874, 1 RCA-57; total 5
Dimensions.....height 7¼", width 12", depth 7"
Weight.....25 lbs.
List Price (complete with tubes).....

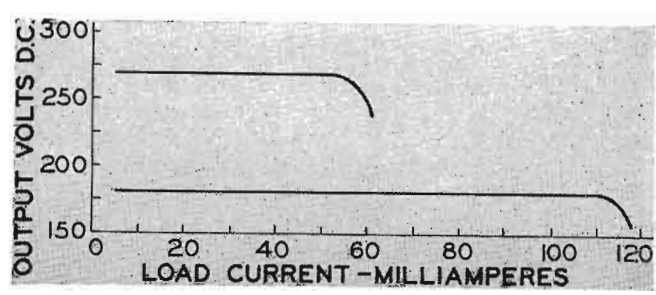

310-A voltage regulation vs. load with constant line voltage.

VIBRATOR POWER UNIT Type 93-A

Applications: The Type 93-A Vibrator Power Unit has been designed for use with field test equipments, and provides sufficient power for simultaneous operation of the Type 301-A or 75-B Field-Intensity Meter with the Type 302-A Noise Meter.

Description: This device comprises a synchronous vibrator and transformer for procuring high-voltage d.c. from a 6-volt storage battery. The high-voltage supply is maintained constant over the normal discharge-cycle of the storage battery by a voltage-regulator tube. The cabinet houses the storage battery, power cable and accessory "C" batteries.



Features: Regulated circuit, insuring constant output over voltage range during discharge of storage battery; proper filtering, reducing hum level to a minimum; two values of output, available for use where required.

Specifications:

Maximum output { (a).....30 or 45 ma at 150 volts
(b).....7.3 ma at 90 volts
Hum level.....less than 2 millivolts on full (150-volt) output
Power supply.....6-volt, 38 ampere-hour, storage battery
Radiotrons.....1 RCA-VR-150-30
Dimensions.....height 14", width 13½", depth 7½"
Weight (less battery).....16 lbs.
List Price (complete with tubes).....

VIBRATOR POWER SUPPLY No. 9785

Applications: The No. 9785 Vibrator Power Supply provides alternating current of normal line potential (110 volts) for operation of a-e powered test equipments from either a 6- or a 12-volt storage battery.

Description: The No. 9785 Power Supply contains a vibrating interruptor and a transformer. The output voltage is controlled by a 7-point tap switch and indicated by a meter, both on the control panel. Permanently attached cables extend from the unit for input and output connections.

Features: Vibrator of plug-in construction for easy replacement; compactness and light weight for portability.

Specifications:

Output: Voltage.....110-120 volts
Power (maximum).....50 watts
Frequency.....70 to 85 cycles
Input: 6-volt operation (full load).....5 to 8 volts, 8 to 10 amperes
12-volt operation (full load).....12 to 18 volts, 4 to 5 amperes
Power consumption.....70 watts average
Dimensions.....height (overall) 9¼", width 7½", depth 14"
Weight.....20 lbs.
List Price (complete).....



POWER SUPPLY EQUIPMENT

PLATE AND FILAMENT SUPPLIES

A-C REGULATED POWER UNIT Type 580-A

Applications: This equipment is designed to furnish plate-supply power for large radio and television apparatus. Loads up to 400 milliamperes at 300 volts d.c. are permissible.

Description: The Type 580-A contains a full-wave rectifier, and a reactor input filter whose output is passed through series regulator tubes controlled by a d-c amplifier. Negligible ripple and excellent regulation characterize this unit.

A special filter panel, Type 582-A, is available for external use with this equipment. It contains a 1000 - mfd

capacitor for connection in the d-c output circuit.

Features: Special regulating circuit maintaining constant output irrespective of normal variations in line voltage and load requirements; excellent regulation; negligible ripple content; designed for rack mounting.

Specifications:

Maximum output.....400 ma at 300 volts
 Regulation..... \pm 1 volt, 50 to 400 ma
 Hum level.....less than 0.05 volt
 Power supply.....110-120 volts, 60 cycles
 Power consumption.....425 watts
 Radiotrons.....2 RCA-VR-150, 2 RCA-5U4-G, 5 RCA-6Y6-G,
 1 RCA-1852; total 10
 Dimensions.....height 10½", width 19", depth 12½"
 List Price 580-A (less tubes).....
 List Price 582-A Filter Panel.....

REGULATED POWER SUPPLY MI-3526

This unit provides regulated plate and filament current for 6.3-volt heater tubes. It furnishes up to 50 ma at 250 volts, and a control is provided for reducing the output down to

135 volts. Somewhat higher current is permissible at lower output voltage. A special regulating circuit holds output essentially constant over a wide range of load and line - voltage variations.

Specifications:

Output: "B".....up to 50 ma at 250 volts d.c.
 "A".....3.2 amperes at 7 volts a.c.
 Hum level.....80 microvolts at 250 volts d.c.
 Power supply.....90-125 volts, 50-60 cycles
 Power consumption.....115 watts
 Radiotrons...1 RCA-874, 1 RCA-80, 1 RCA-59, 1 RCA-57; total 4
 Dimensions.....height 6⅞", width 16½", depth 14"
 Weight.....50 lbs.
 List Price (less tubes).....

FILAMENT SUPPLY UNIT MI-1500

This unit furnishes d-c filament voltages up to 12 amperes at 15 volts. Operating from a 110-volt a-c line, it contains two RCA rectifier bulbs connected in a full-wave circuit. A two-section choke-input filter and bleeder resistor in the output circuit insure low ripple content and good regulation. In applications where still further reduction of ripple is desirable, the MI-3528 Supply Unit is recommended.

Specifications:

Output.....12 amperes at 15 volts d.c.
 Hum level.....less than 0.04 volt
 Power supply.....105-125 volts, 50-60 cycles
 Power consumption.....450 watts
 Radiotrons.....2 RCA-2000
 Dimensions.....height 20½", width 18¾", depth 12"
 Weight.....110 lbs.
 List Price (less tubes).....

FILAMENT SUPPLY UNIT MI-1520

The MI-1520 Supply Unit furnishes filament power up to 5 amperes at 12 volts, and is equipped with a control for output-voltage adjustment.

It embodies a full-wave rectifier circuit using two Tungar bulbs and a choke-input two-section filter for reducing the ripple content. Still lower ripple content is obtainable in a similar unit, the MI-3527.

Specifications:

Output.....5 amperes at 12 volts d.c.
 Hum level.....less than 0.03 volt
 Power supply.....105-125 volts, 50-60 cycles
 Power consumption.....200 watts
 Tungar Tubes.....2 No. 20X672
 Dimensions.....height 17⅝", width 15⅞", depth 9¼"
 Weight.....62 lbs.
 List Price (less tubes).....

VOLTAGE-REGULATING TRANSFORMER No. 9796

The No. 9796 Voltage-Regulating Transformer is an a-c voltage-regulating device that may be used to permit operation of calibrated test equipment on lines subject to severe surges. Its primary application is in the industrial field where line-voltage fluctuations are caused by heavy machinery, arc welders, etc. It is practically a necessity for use with cathode-ray oscillographs which must be operated under such conditions. A complete description of this item is given on page 19.

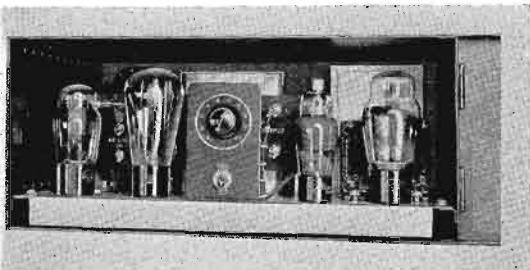
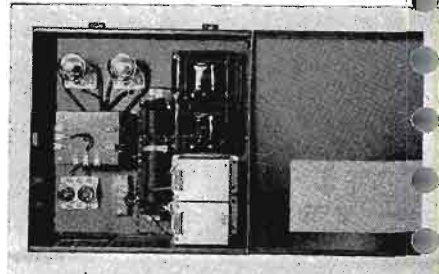
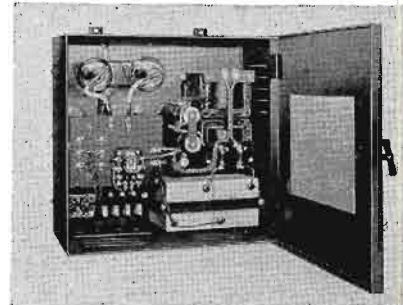
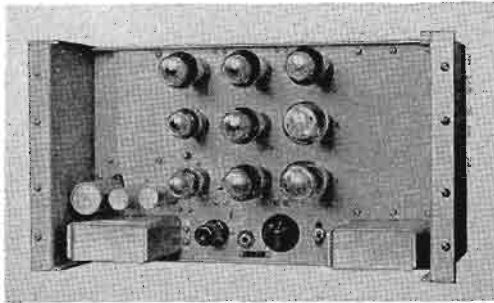

A-F & R-F MEASURING EQUIPMENT

AUDIO-FREQUENCY INSTRUMENTS

BEAT-FREQUENCY OSCILLATOR Type 68-B

Applications: The Type 68-B Beat-Frequency Oscillator is a high-quality laboratory-type audio oscillator having negligible distortion. It is unexcelled as an audio source for making distortion measurements, and may be used in any form of development work where a source of exceptionally pure audio frequencies is necessary. It has many other uses, such as for studying the frequency characteristics of transformers, amplifiers and commercial sound systems. Its output is essentially constant over the entire frequency range.

Description: Operation of this equipment is based on the conventional beat-frequency principle of heterodyning two radio-frequency voltages to form the low-frequency audio-output voltage. The two r-f voltages are generated by independent oscillators, one fixed in frequency and the other variable. Reaction between these oscillators is avoided by the use of electron coupling and very efficient shielding. Distortion is minimized by completely shielding the two oscillators, by maintaining a high ratio between the two r-f signal voltages, and by using balanced push-pull detector and amplifier stages throughout. A meter is provided to enable proper matching of tubes for these push-pull circuits.

Output impedances of 250, 500 and 5000 ohms are available from a terminal board at the rear. The output jacks on the front panel facilitate external connections in rack-mounted models. In cabinet models, the output terminals are accessible from a terminal strip on the side of the instrument.

Features: Vernier-controlled pointer traveling over a large direct-reading scale, for easy adjustment of frequency; electron-ray tube permitting ready checking of calibration

Curves like these may be obtained using the 68-B

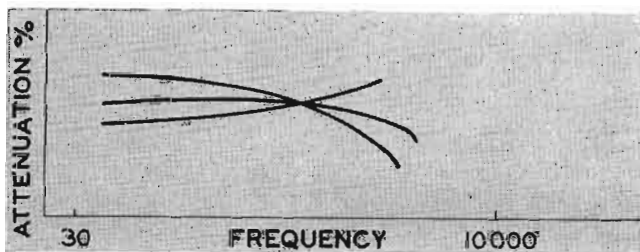

Typical line-equalization curves obtained by means of the 68-B

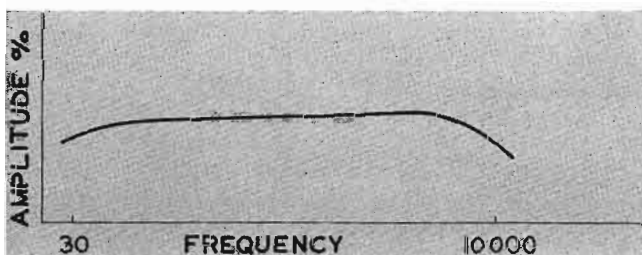

Example of typical frequency-response curve obtainable with 68-B

against the power-supply frequency; well-shielded electron-coupled oscillators, and push-pull detector and amplifier circuits, providing exceptional freedom from distortion; electronically regulated, built-in power supply, assuring constancy of output, irrespective of normal line-voltage fluctuations; extremely compact design, requiring only $8\frac{3}{4}$ " of rack space.



The Type 68-B Beat-Frequency Oscillator, used in conjunction with the Type 69-A Distortion Meter described on page 10, is ideal for making harmonic distortion measurements on broadcast transmitters. Another unit useful in this application is the Type 89-A Attenuator Panel, by means of which suitable attenuation can be introduced to feed the distortion meter and the equipment under test. This unit, described on page 11, will save considerable time in setting up equipment for measurement.

A portable beat-frequency oscillator, Stock No. 154, is also available. This instrument is built primarily for field service applications, such as testing loudspeakers and public-address systems where requirements for accuracy of measurement are less stringent.

Specifications:

Frequency range.....	20-17,000 cycles
Usable output down to	5 cycles
Calibration accuracy	
Within 1 cycle below 100 cycles; within 1% above 100 cycles	
Power output.....	up to 125 milliwatts
Voltage output.....	up to 25 volts
Distortion.....	(arithmetical sum of harmonics at full output)
Less than 0.3% below 100 cycles; less than 0.2% above 100 cycles	
Hum.....	60 db below zero level (zero db = 12.5 mw, 500 ohms)
Output impedances.....	250, 500 and 5000 ohms, balanced
Fidelity characteristics	
5000 ohms.....	flat within 0.5 db
500 or 250 ohms.....	flat within 1 db
Power supply.....	110-125 volts, 25-60 cycles
Power consumption.....	70 watts
Radiotrons.....	6 RCA-6C5-G, 3 RCA-6J7, 1 RCA-45, 1 RCA-874 1 RCA-5Z4, 1 RCA-6E5; total 13
Height (Rack Model).....	$8\frac{3}{4}$ " (Cabinet Model)..... 9"
Width (Rack Model).....	19" (Cabinet Model)..... $19\frac{1}{4}$ "
Depth (Rack Model).....	$10\frac{3}{4}$ " (Cabinet Model)..... 11"
Weight (Rack Model).....	50 lbs. (Cabinet Model)..... 55 lbs.
List Price (Rack Model, complete with tubes).....	
List Price (Cabinet Model, complete with tubes).....	

A-F & R-F MEASURING EQUIPMENT

AUDIO-FREQUENCY INSTRUMENTS

DISTORTION METER Type 69-A

Applications: The Type 69-A Distortion Meter, used with a low-distortion audio oscillator such as the Type 68-B, permits rapid measurement of distortion, noise and frequency-response characteristics of broadcast installations from studio to antenna. Harmonic distortion can be determined at any frequency within the normal audio range. This is an outstanding advantage over most other comparable instruments which are usable only at specified frequencies. Since the distortion content may be many times greater at high and low frequencies than at the middle of the band, it is evident that single-frequency measurements are inadequate and often not even representative. The Type 69-A is reliable from 50 to 7000 cycles, this range including all frequencies at which there will be any large amount of power.

Fundamentally a laboratory instrument, the Type 69-A also finds many applications in radio development work. On radio receivers, for example, it is invaluable for measurements such as signal-to-noise ratio, hum level, and automatic volume-control range, as well as for locating sources of distortion. The instrument may also be used as a highly sensitive amplifier-voltmeter, its frequency characteristic being practically flat from 50 to 25,000 cycles.

Description: In the Type 69-A, both distortion and noise measurements are indicated by a direct-reading, multi-scale meter, actuated through an eleven-position selector switch.

Distortion measurements are made by balancing out the fundamental frequency of the unknown wave by the introduction of a sine wave equivalent in frequency and amplitude, but 180 degrees displaced in phase. This cancellation is accomplished by applying the unknown and sine waves to the respective grids of two tubes, whose output circuits



are connected in push-pull. The remainder, or harmonic content of the unknown wave, is measured by the meter as a total r-m-s percentage of the fundamental amplitude.

Audio-input impedances of 20,000 and 250,000 ohms allow bridging or direct-to-tube connection, as desired. A built-in linear r-f rectifier provides for measurements of distortion and noise in the modulated carrier output of transmitters. The output of this device is available for external connection of a cathode-ray oscillograph for wave analysis.

The Type 69-A Distortion Meter is mounted on a standard 19-inch rack panel and requires only $8\frac{3}{4}$ " of rack space. If preferred, it can be supplied in a sturdy metal cabinet suitable for table mounting.

Features: The outstanding feature of this instrument is its ability to measure distortion content and noise level over a wide range of audio frequencies. Other features are: easy, rapid calibration, accomplished without the use of other equipment; provision for bridging or direct-to-tube audio inputs; linear r-f rectifier included for direct measurement in the modulated output of transmitters; extreme compactness of design, only $8\frac{3}{4}$ " of rack height being required.

Specifications:

Frequency range for distortion measurements... 50 to 7,000 cycles
 Distortion measurement range... 0.3% to 100%
 Five scale ranges... 1%, 3%, 10%, 30% and 100%
 Noise-level measurement range... down to 85 db below zero level (12.5 mw, 500 ohms) or below 100% modulation

Audio input impedance:

Bridging (balanced to ground)... 20,000 ohms
 Direct-to-tube (unbalanced)... 250,000 ohms

Input level:

A-F: 20,000-ohm input... -15 db to +10 db
 250,000-ohm input... 0.5 to 100 volts
 R-F: For distortion measurements... 10 to 100 volts
 For hum measurements... 0.5 to 100 volts

Frequency characteristics:

Bridging input... flat from 50 to 15,000 cycles
 Direct to tubes... flat within 1 db from 50 to 25,000 cycles

Power supply... 105-125 volts, 25-60 cycles
 Power consumption... 50 watts
 Radiotrons... 3 RCA-6C5, 1 RCA-6N7, 1 RCA-6X5-G, 1 RCA-5Z4; total 6

Dimensions:

Height (Rack Model)... $8\frac{3}{4}$ " (Cabinet Model)... 9"
 Width (Rack Model)... 19" (Cabinet Model)... $19\frac{1}{4}$ "
 Depth (Rack Model)... 10" (Cabinet Model)... 12"
 Weight (Rack Model)... 52 lbs. (Cabinet Model)... 63 lbs.

List Price (Rack Model) (complete with tubes).....
 List Price (Cabinet only).....

Curves like these may be obtained using the 69-A

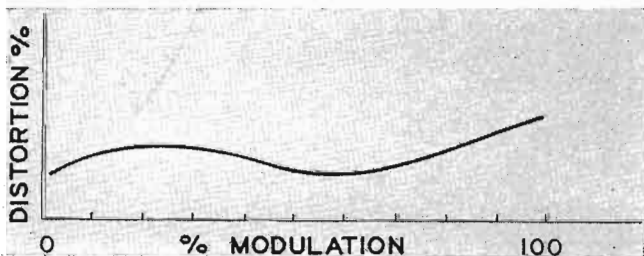

Curve measuring distortion in terms of modulation, indicated by 69-A

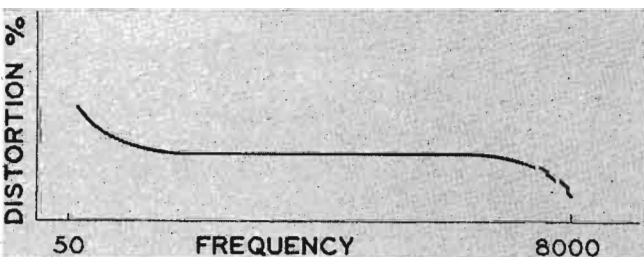

Curve showing distortion at various frequencies, indicated by 69-A

A-F & R-F MEASURING EQUIPMENT

AUDIO-FREQUENCY INSTRUMENTS

ATTENUATOR PANEL Type 89-A



Applications: The Type 89-A Attenuator Panel greatly facilitates use of the Type 68-B and 69-A instruments by simplifying the work of setting up equipment for various measurements. It is particularly useful in broadcasting stations and laboratories because the improvement in operating convenience means a saving of much valuable time. It contains an excellent volume indicator, useful also for general measurement purposes.

Description: The Type 89-A consists of a volume-indicator meter, an attenuator system, an impedance-matching system, and jacks for external connections. A switch permits connection of the volume indicator to the attenuator system or to jacks. The attenuator system serves to control independently the amplitude of signal supplied by the beat-frequency oscillator to the equipment under test and to the distortion meter. Four switches in this system permit introduction of attenuation up to 75 db in steps of 5 db between the input and output jacks. Since the volume-indicator meter is also calibrated in decibels, direct reading of the input and output levels of the attenuator system is possible. An output-impedance switch allows matching to 500-, 250-, or 50-ohm circuits. It may also be obtained to match 600 ohm circuits and calibrated for a zero level of 1 mw., 600 ohms. The equipment is available in both rack and cabinet types.

Features: Panel jacks, affording utmost convenience in making all necessary connections; direct reading of input and output levels; volume indicator which may be used independently for measuring levels of other apparatus; choice of three output impedances providing ready matching to all commonly used circuits; compact design requiring only 5¼" of rack space.

Specifications:

Impedance values:

Input.....	500 ohms
Output.....	500, 250 or 50 ohms
Volume indicator.....	20,000 ohms
Volume-indicator range	12.5-mw. zero level..... -10 to +12 db
	1.0-mw. zero level..... 0 to +22 db
Attenuation.....	0 to 75 db in 5-db steps

Operating limits:

Input level.....	-10 to +12 db
Output, 500 ohms.....	-85 to +12 db
Output, 250 ohms.....	-95 to +2 db
Output, 50 ohms.....	-105 to -8 db

Dimensions:

Height (Rack Model).....	5¼"	(Cabinet Model).....	5¼"
Width (Rack Model).....	19"	(Cabinet Model).....	19⅜"
Depth (Rack Model).....	7"	(Cabinet Model).....	8⅝"
Weight (Rack Model).....	16 lbs.	(Cabinet Model).....	18 lbs.

List Price (Rack Model).....	
List Price (cabinet only).....	

VOLUME INDICATOR Type 13-D

Applications: The Type 13-D Volume Indicator is designed for accurate and convenient monitoring of program level in broadcast installations. It also has many uses in fields other than broadcasting, such as in measuring signal levels in sound-recording systems and on telephone lines.

Description: The Type 13-D is a high-fidelity, vacuum-tube voltmeter with adjustable dynamic response. Four meter speeds are provided to meet varying requirements of diverse applications. One gives a "floating" reading in accordance with F.C.C. specifications for modulation monitors; a second gives approximate "peak" readings; a third gives "average" readings; the fourth is the "high-speed" action of the meter alone. Any speed may be selected by the timing switch.

A signal rectifier of the vacuum-tube type is employed, insuring a sustained high degree of accuracy. Use of an isolation amplifier preceding this rectifier prevents reflection on the source. Input impedances of 500 and 20,000 ohms are available to permit use of either terminating or bridging connections.

Features: Direct indication of signal levels in decibels on large attenuator scale used in conjunction with meter; attenuator permitting zero indication of meter to be shifted from -20 to +18 db, thus providing measurement ranges of -30 to +20 db or -48 to +2 db, as desired; internal calibration source, adjustable for either 6- or 12.5-mw reference level, four meter speeds permitting choice of floating, peak, average, or high-speed readings; terminals at rear permitting connection of external meter for remote indication.

Specifications:

Measurement range.....	-30 to +20 db or -48 to +2 db (0 db = 12.5 mw, 500 ohms)
Frequency response.....	±0.5 db from 30 to 10,000 cycles
Input impedance.....	500 or 20,000 ohms
Power supply.....	105-125 volts, 50-60 cycles
Power consumption.....	.30 watts
Radiotrons.....	2 RCA-76, 1 RCA-6A6, 2 RCA-84; total 5
Dimensions.....	height 6 ³¹ / ₃₂ ", width 19", depth 7 ³ / ₄ "
Weight.....	25 lbs.
List Price (less tubes).....	

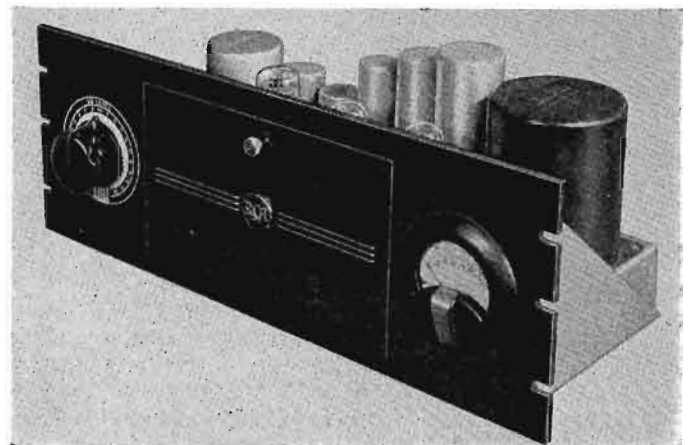

A-F & R-F MEASURING EQUIPMENT

RADIO-FREQUENCY INSTRUMENTS

FREQUENCY-LIMIT MONITOR Type 303-A

Applications: The Type 303-A Frequency-Limit Monitor is designed for checking the carrier frequency of transmitters operating in the range of 1500 kc to 45 megacycles, and indicating when the drift exceeds specified limits. This range includes high-frequency broadcast, international broadcast, police, and aviation services. The frequencies of mobile police transmitters and portable broadcast transmitters can also be checked or monitored with this device. It is likewise suitable for calibrating receivers, as a frequency meter for checking remote transmitters, and related applications, for which the monitor crystal oscillator provides a signal of known frequency.

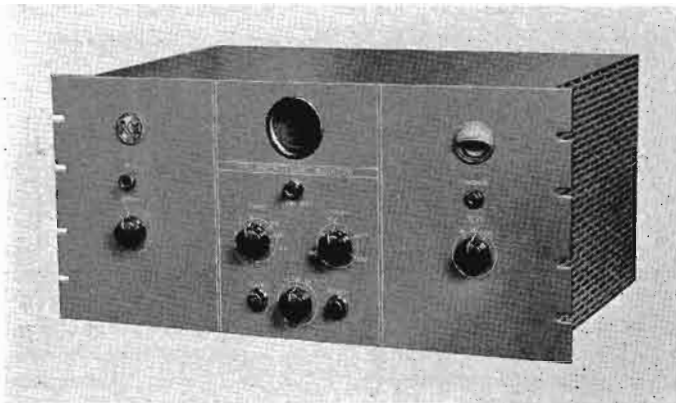

Description: The monitor controls are set for a predetermined limit of permissible frequency deviation; and if this tolerance is exceeded, the panel lamp will light, giving an immediate visual warning. These controls are so calibrated that the frequency deviation may be determined directly in cycles per second.

Monitoring is accomplished by the heterodyne principle, the carrier frequency being adjusted to beat with a local crystal oscillator emitting a signal (fundamental or harmonic) at the assigned transmitter frequency. The beat note between the two may be observed in head phones and will be the true difference tone. A jack is provided on the front panel for this phone connection. It is possible to easily determine whether the deviation is higher or lower than the carrier frequency by listening to the audio tone in the head phones while pressing a push button, noting whether the pitch increases or decreases. Four crystal positions are available, permitting use of this instrument on as many as four different channels within the overall frequency range through the crystal selector switch.

A magic-eye tube is provided for checking the r-f input level, oscillation of crystals, and operation of detector and audio-limit circuit. An extremely wide range of deviation may be monitored—50 to 25,000 cycles. This instrument can be supplied for either rack or table mounting, the latter type being furnished in a strong metal cabinet.

Features: Extreme accuracy of measurement, far in excess of average requirements, measurements within 0.005% being possible; employment of V-cut, low temperature-coefficient crystals, and mounting of the entire crystal-oscillator circuit in a heat-controlled chamber, insuring

operating stability; economical operation obtained by means of a standby position in which only the crystal heaters are energized; convenient limit method of monitoring employed, necessitating only a glance at the panel to determine whether the transmitter is operating within the required limits.

Specifications:

Carrier frequency range..... 1500 kc to 45 mc
 Frequency-deviation range..... 50 to 25,000 cycles
 Accuracy..... 0.005%
 Power supply..... 105-125 volts, 50-60 cycles
 Power consumption..... 100/125 watts total (operating),
 15 watts average (standby)

Radiotrons... 1 RCA 1612, 1 RCA-6J5-G, 1 RCA-6K7, 1 RCA-6J5
 1 RCA-6E5, 1 RCA-6H6, 1 RCA-6Y6-G, 1 RCA-5U4-G; total 8

Dimensions:

Height (Rack Model)... 8 $\frac{3}{4}$ " (Cabinet Model)..... 9 $\frac{1}{4}$ "
 Width (Rack Model)... 19" (Cabinet Model)..... 20"
 Depth (Rack Model)... 13 $\frac{1}{8}$ " (Cabinet Model)..... 13 $\frac{5}{8}$ "
 Weight (Rack Model)... 58 lbs. (Cabinet Model)..... 68 lbs.

List Price (Rack Model) (with tubes; less crystals).....
 List Price (Cabinet Model) (with tubes; less crystals).....

MODULATION MONITOR Type 66-A

Applications: The Type 66-A Modulation Monitor enables rapid checking of percentage modulation of broadcast transmitters, incorporating a neon peak flash lamp which furnishes an instant indication or warning when the degree of modulation exceeds a predetermined value. It satisfies the requirements of the Federal Communications Commission as set forth in Rule 139, Section (b). Readings can be made on either positive or negative modulation peaks. The instrument can be used in other applications in addition to its primary function, being particularly useful for measurements of average carrier value during modulation, carrier shift upon application of modulation, and program levels.

Description: This modulation monitor contains a linear diode r-f rectifier feeding two branch circuits, one for the neon peak indicator and the other for the modulation meter. A d-c milliammeter is employed in the plate circuit of the rectifier to indicate the average carrier value and carrier shift during modulation. The peak-indicator branch circuit consists of an amplifier which triggers a gaseous discharge tube for operation of the neon lamp. Adjustment of the amplifier bias provides for operation at any value from 50% to 120% positive modulation, or from 50% to 100% negative modulation. The second branch incorporates a diode detector and a vacuum-tube voltmeter with the modulation meter connected in its cathode circuit.

The Type 66-A Monitor is provided with extra-large (4 $\frac{1}{2}$ ") meters and a built-in relay for operation of a peak counter or auxiliary alarm. It is mounted on an 8 $\frac{3}{4}$ " panel for standard relay-rack applications, but can also be furnished with a cabinet where table mounting is preferred.

Features: Approval of F.C.C. (Approval No. 1552), covering every requirement as to meter response, accuracy, frequency characteristics, and independence of supply-

A-F & R-F MEASURING EQUIPMENT

RADIO-FREQUENCY INSTRUMENTS

voltage variation; peak indicator which provides flashing signal as warning of over-modulation; direct reading of modulation percentages on either positive or negative peaks; built-in relay permitting connection of an external peak counter or auxiliary alarm.

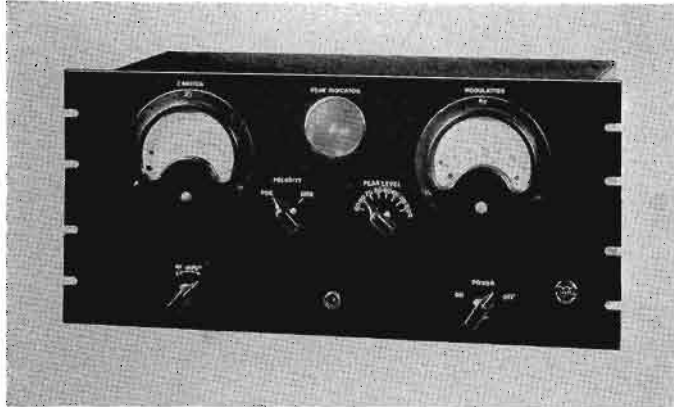

Specifications:

General operating characteristics..... as per F.C.C. regulations
 Accuracy (of percentage modulation readings)..... $\pm 2\%$ at 100% modulation, $\pm 4\%$ at any other percentage modulation
 Frequency response..... ± 0.5 db from 30 to 10,000 cycles
 R-F input..... 0.16 watt
 Power supply..... 110-120 volts, 50-60 cycles
 Power consumption..... 40 watts
 Radiotrons... 1 RCA-1-V, 3 RCA-76, 1 RCA-84, 1 RCA-885; total 6
 Dimensions:
 Height (Rack Model)... $8\frac{3}{4}$ " (Cabinet Model)..... 9"
 Width (Rack Model)... 19" (Cabinet Model)... $19\frac{1}{4}$ "
 Depth (Rack Model)... $10\frac{3}{4}$ " (Cabinet Model)..... 11"
 Weight (Rack Model)... 50 lbs. (Cabinet Model)... 55 lbs.
 List Price (Rack Model, complete with tubes).....
 List Price (cabinet only).....

PHASE METER Type 300-A

Applications: The Type 300-A Phase Meter provides a simple means of accurately measuring phase differences between currents in the various towers of an antenna array. It is particularly useful in checking directional arrays to insure proper phasing and hence proper field pattern. All phase angles up to 360 degrees at any frequency between 200 and 1600 kc can be measured.

In addition to the above measurements, this instrument may be used to adjust phase-shifting networks, to measure impedances of arrays, and to facilitate calculation of mutual impedances of antennas. It enables quick and accurate phase measurements to be made between the elements of a directional antenna array, not only initially, but also as a routine check to make certain that the pattern has not shifted.

The instrument accommodates up to six lines, permitting the taking of measurements between any two elements in systems having up to six elements. Selector switches are provided, enabling the operator to select any two lines at a time. The operation of the instrument is not affected by

modulation; consequently, measurements may be made at any time while the station is on the air.

In addition to measurements of the phase difference between currents in various antenna towers, a number of other types of measurement are within the scope of the Type 300-A Phase Meter. It is useful in any application where phase angles between r-f currents or voltages are involved.

Description: The phase meter consists essentially of two resistance-coupled, three-stage, radio-frequency amplifiers which feed the two sets of deflection plates of a cathode-ray tube. One of the amplifiers contains a calibrated phase-shifting network which may be adjusted to secure an indication of in-phase conditions on the oscilloscope screen. The amount of phase shift introduced is then equal to the phase difference between the two input signals, and is read directly from the dial scale. The input impedance is approximately 80 ohms, permitting matching to low-impedance cables, and the required input signal is only one-half volt. The instrument is designed for standard relay-rack mounting, and requires $8\frac{3}{4}$ " of rack space.

Features: Oscilloscope providing visual indication of proper adjustment; direct reading of phase angle in degrees from calibrated dial operating phase-shifting network; operation unaffected by modulation, permitting measurements to be made at any time while the station is on the air; facilities for connecting up to six r-f inputs simultaneously, a selector switch permitting measurements between any two of the six circuits as desired.



Specifications:

Phase-angle range..... 0 to 360 degrees
 Frequency range..... 200 to 1600 kc
 R-F input impedance..... 80 ohms
 R-F input voltage (approx.)... 0.5 volt minimum, 2 volts maximum
 Power supply..... 105-125 volts, 50-60 cycles
 Power consumption..... 120 watts
 Radiotrons..... 2 RCA-956, 3 RCA-1617, 2 RCA-89, 1 RCA-913, 1 RCA-5Z3; total 9
 Dimensions..... height $8\frac{3}{4}$ ", width 19", depth 11"
 Weight..... 42 lbs.
 List Price (complete with tubes).....

A-F & R-F MEASURING EQUIPMENT

RADIO-FREQUENCY INSTRUMENTS

U-H-F FIELD-INTENSITY METER Type 301-A

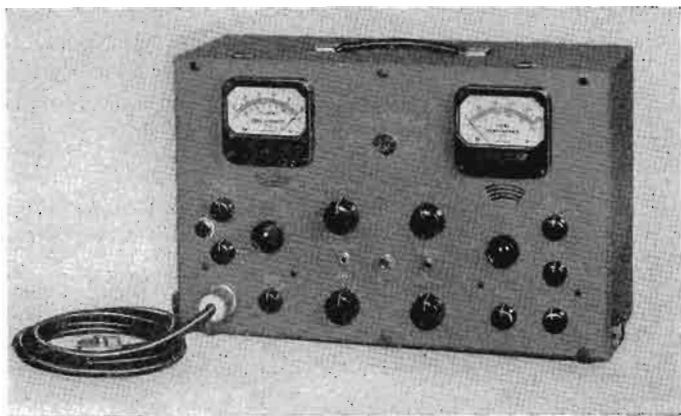

Applications: This field-intensity meter is capable of accurately measuring field strengths of stations operating in the range of 20 to 125 megacycles. Since its range includes the channels assigned to television broadcasting, this instrument is of great utility in that field.

Description: The Type 301-A Field-Intensity Meter is essentially a superheterodyne receiver equipped with a calibrating oscillator and an output meter. The receiver circuit comprises the conventional heterodyne oscillator and first-detector stages; three i-f amplifier stages; and a combined second detector, automatic volume control, and d-c amplifier stage. A vacuum-type thermocouple is employed for measuring the output of the calibrating oscillator.

The accessory case illustrated below contains an adjustable doublet-type antenna, an insulated tripod, and thirty feet of transmission line. The tripod may be extended in height sufficiently to permit rotation of the antenna for any plane of polarization of transmission.

Features: Coverage of exceptionally wide frequency and field-intensity ranges; choice of linear or logarithmic operation; provision for connection of a recorder to obtain field-intensity readings over periods of time; jack on panel permitting connection of headphones for audio monitoring, or a 302-A meter for determination of signal-to-noise ratio*; doublet antenna and shielded transmission line, insuring excellent pick-up of high-frequency signals.

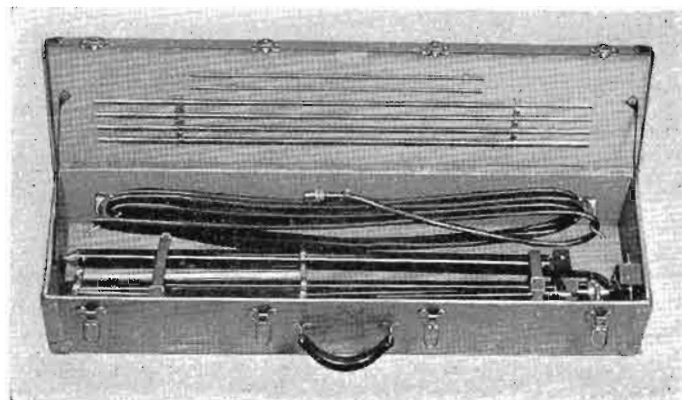

Specifications:

Frequency range (overall, 3 bands)..... 20 to 125 mc
 Field-intensity range:
 Low-frequency (20 mc)..... 10 to 500,000 mv per meter
 High-frequency (125 mc)..... 50 to 2,500,000 mv per meter
 Output scales:
 Linear..... 10 to 1 or 20 db
 Logarithmic..... 100 to 1 or 40 db
 Output:
 Audio..... operates phones or 302-A noise meter
 Recorder... operates any recorder of 5 ma and 560 ohms, max.
 Recommended antenna facilities..... Accessory Case, comprising:
 (a) Antenna—Stainless steel, doublet type, consisting of one telescoping section on each side, covering entire frequency range down to 37.5 mc; and two fixed sections per side, utilized as extensions for lower frequencies down to 18 mc.
 (b) Antenna Support—Bakelite tripod adjustable to 138 inches in height for supporting doublet antenna in any position.
 (c) R-F Transmission Line—Two-conductor, shielded, rubber-covered wire, 30 feet in length.
 Recommended power supply..... Type 93-A Vibrator Power Unit
 Power requirements:
 “A”..... 6 volts, 1.65 amperes
 “B”..... 150 volts, 39 ma (max.)
 Radiotrons..... 1 RCA-954, 2 RCA-955, 3 RCA-6K7, 1 RCA-6R7; total 7
 Dimensions:
 Meter (MI-7549)..... Height 13" Width 20 $\frac{3}{8}$ " Depth 9 $\frac{1}{4}$ " Weight 38 lbs.
 Accessory Case (MI-7548)..... Height 12" Width 39" Depth 7 $\frac{3}{8}$ " Weight 24 lbs.
 List Price (including power supply, tubes, and accessories).....

FIELD-INTENSITY METER Type 75-B

For measurements of broadcast-station field intensity in the range of 500 to 20,000 kilocycles, the Type 75-B Field-Intensity Meter is recommended. This instrument is an easily operated, portable equipment of extremely rugged design and construction, enabling it to withstand the severest usage in the field. Because of its simplicity, it becomes an easy matter with this instrument to make surveys, measure effective station coverage, select transmitter sites, determine radiation patterns, or check the strength of harmonics.*

The equipment is similar in operation to the Type 301-A already described, but employs the loop-type antenna. In covering the entire frequency range, four sets of loops and front-panel plug-in coils are employed. An extra loop and three extra coils are available for extending the frequency range down to 150 kc.

The equipment is highly portable, being compactly assembled in two aluminum carrying cases. The meter itself is contained in one of these, while the other contains all loops, coils, and batteries. If desired, the Type 93-A Vibrator Power Unit (see page 7) may be adapted for operation of this instrument.

Specifications:

Frequency range (overall, 4 bands)..... 500 to 20,000 kc
 Field-intensity range..... 20 microvolts to six volts per meter
 Accuracy..... within 10%
 Radiotrons..... 1 RCA-6C6, 3 RCA-6D6, 2 RCA-30, 1 RCA-85; total 7
 Dimensions:
 Meter..... Height 11 $\frac{3}{4}$ " Width 24 $\frac{1}{2}$ " Depth 9 $\frac{1}{2}$ " Weight 30 lbs.
 Accessory Case..... Height 13" Width 20 $\frac{1}{2}$ " Depth 9" Weight 30 lbs.
 List Price (including two sets of tubes; less batteries).....

*NOTE: See page 6 for Type 302-A A-F Meter for indicating signal-to-noise ratios with 301-A or 75-B instruments.

TELEVISION MEASURING EQUIPMENT

CATHODE-RAY OSCILLOGRAPH

The "Video" frequencies employed in television circuits, extending from about 30 to 4,000,000 cycles, have necessitated the development of special laboratory equipment and technique in order to obtain the requisite accuracy for measurement and investigation of these circuits. RCA, during its long experience in the television field, has developed a number of high-quality instruments especially designed for the exacting requirements of television.

Among those described in this section is a square-wave generator designed to produce waves over a wide range of frequencies with extremely steep sides and a flat top. Such waves are very useful for rapidly checking the transient characteristics of video amplifiers with an accurate cathode-ray oscillograph. By supplying square waves to the input of the circuit under test, any distortion observable in the output wave may readily be interpreted with respect to frequency response and phase shift. The special cathode-ray oscillograph described in this section has been designed not only for this purpose, but also for studies and adjustments of amplitudes and wave shapes of the synchronizing impulses, blanking impulses, and picture signal.

Two television sweep oscillators are available, one covering the video frequencies and the other the intermediate and ultra-high frequencies. These units have been designed for use with the oscillograph to eliminate laborious point-by-point measurement of frequency-response characteristics and to enable rapid circuit alignment.

The synchronizing generator described herein is a very complete equipment which may be used in the establishment of small test systems as well as with larger transmitters operating on regular schedules.

9" SPECIAL CATHODE-RAY OSCILLOGRAPH Type 305-A

Applications: The Type 305-A Cathode-Ray Oscillograph may be used in all general applications, and possesses advantages over other types of oscillographs because of its extremely wide frequency range. It is highly valuable for modulation measurements on transmitters or for study of impulses or transients, showing wave shape of combined noise and desired signal. The 305-A is applicable to any class of work where low- or high-frequency voltages of small amplitude must be studied. Also, since the horizontal and vertical amplifiers are identical and admit use of a wide range of input voltages, the instrument is ideally suited for measurement of phase delay in amplifiers and networks.

Because of its excellent frequency-response characteristics, this oscillograph may be used as a peak-reading voltmeter over an input range of 0.05 to 400 volts. A 60-cycle calibration source is provided by a metered circuit in the equipment, measurements being made by the substitution method. Thus the voltage at any portion of the wave may readily be determined.

Description: The deflection amplifiers of this de luxe cathode-ray oscillograph have been exceptionally well designed. Their response is essentially flat from 30 cycles to 10 megacycles; and, using square-wave input, distortion is under 5% at 30 cycles.

An integral saw-tooth oscillator provides linear timing, and may be synchronized with the signal in the vertical amplifier or with an external frequency. The synchronizing

signal may be applied in either polarity, as desired. A phase-changing network permits synchronization of the timing-axis oscillator with the power-supply frequency. A blanking amplifier varies the grid bias of the cathode-ray tube from an external signal for introducing time or frequency calibration.

The cathode-ray tube, the RCA-914, is the largest commercially available, and provides a large, brilliant trace suitable for either visual or photographic observation. The Type 305-A is equipped with large casters to facilitate movement about the laboratory.

Features: Wide-range, high-gain amplifiers; gain control in a-c circuit, stabilizing spot on screen during adjustment; phase-changing network for synchronizing saw-tooth oscillator with power-supply frequency; blanking amplifier for time or frequency determination; internal source of calibration voltage which may be applied to either deflection amplifier, allowing use of oscillograph as a peak-reading voltmeter; regulated plate supply for all tubes, except output stage and cathode-ray tube, assuring independence from line-voltage variation.

Specifications:

Cathode-ray tube.....	RCA-914, 9" screen, electrostatic deflection
Amplifier response.....	30 cycles to 10 megacycles
Timing-axis range.....	30 to 30,000 cycles
Power supply.....	110-120 volts, 50-60 cycles
Power consumption.....	800 watts
Dimensions.....	height 50 $\frac{1}{4}$ ", width 29", depth 34"

List Price and more detailed information may be had on request.

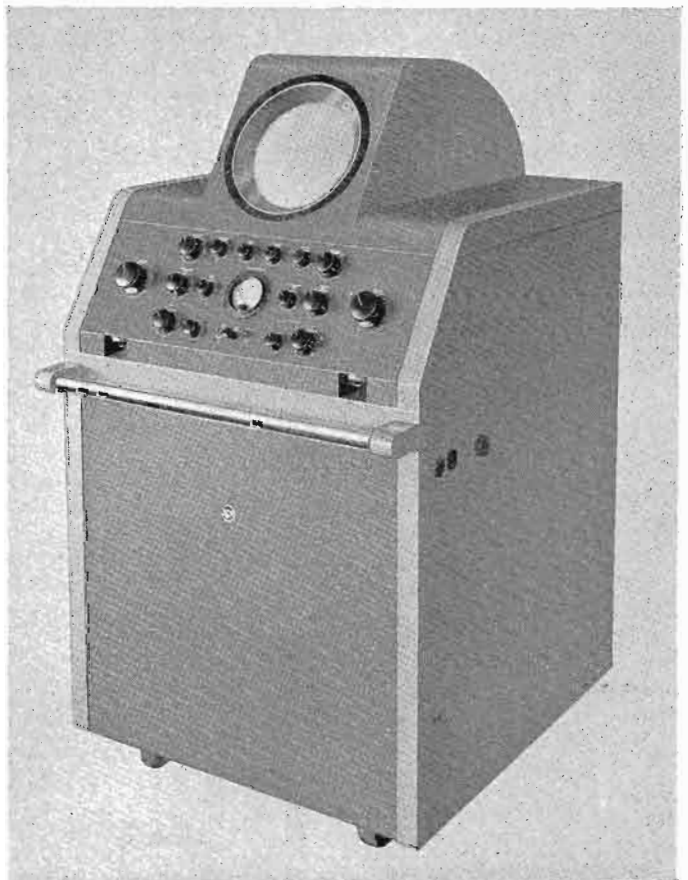

TELEVISION MEASURING EQUIPMENT

FREQUENCY-RESPONSE AND PHASE-INDICATING UNITS

SQUARE-WAVE GENERATOR Type 350-A

Applications: This instrument generates square-wave signals for rapidly checking the transient characteristics of television video amplifiers, in conjunction with a suitable cathode-ray oscillograph.

Description: The Type 350-A Square-Wave Generator offers a choice of five square-wave output frequency ranges, as shown under "Specifications," permitting separation of the low- and high-frequency transient effects.

In addition to square waves, two sinusoidal voltages are also available (range 5). The 100-kc sine wave may be used for horizontal deflection of the oscillograph beam or for synchronizing the timing axis. The 10-mc signal may be applied to the grid of the cathode-ray tube to modulate the spot intensity, thus introducing marker dots on the pattern at time intervals of 0.1 microsecond.

Features: Wide range of square-wave output frequencies providing great flexibility of operation; two sine-wave outputs which may be used for synchronizing the oscillograph sweep and marking time intervals on the oscillograph pattern; regulated power supply assuring optimum performance irrespective of line-voltage fluctuations.

Specifications:

Outputs:

Range	Frequency	Wave Form	Voltage (Peak-to-Peak)	Source
1	3-50 cy.*	Square	0-20 v	Int. Osc.
2	50-60 cy.	Square	0-20 v	Power Supply
3	60 cy.-100 kc	Square	{ 0-20 v below 13 kc 0-3 v above 13 kc }	External
4	13 kc	Square	0-20 v	Int. Osc.
5	100 kc	Square	0-3 v	Int. Osc.
		Sine	0-50 v	
		Sine	0-50 v	

*In seven steps providing approx. frequencies of 3, 5, 8, 12, 30 and 50 cycles.

Rise time:

100-kc square wave (Range 5) will rise from maximum negative to maximum positive potential in approximately 0.12 microsecond. At other frequencies, the square waves will rise in less than 0.01 period if output-voltage limits are not exceeded.

Power supply..... 105-125 volts, 50-60 cycles
 Power consumption..... 120 watts
 Radiotrons... 6 RCA-6C6, 1 RCA-6F7, 3 RCA-6J7-G, 2 RCA-6K7-G,
 2 RCA-991, 1 RCA-2A3, 1 RCA-874, 1 RCA-80, 1 RCA-57;
 total 18
 Dimensions..... height 19 $\frac{3}{4}$ ", width 20 $\frac{1}{2}$ ", depth 9 $\frac{1}{4}$ "
 Weight..... 44 lbs.
 List Price (complete with tubes).....

VIDEO SWEEP OSCILLATOR Type 351-A

Applications: This instrument enables reproduction of the response characteristic of television video and other wide-range amplifiers on the screen of the Type 305-A Oscillograph, for visual investigation and rapid adjustment. It is suitable for use on television transmitters, and is sufficiently portable for field test work on television receivers. When a rectifier, such as the Type 353-A described on page 17, is employed, the Type 304-A Oscillograph may be used instead of the 305-A.

Description: The circuit of the Type 351-A Video Sweep Oscillator comprises a beat-frequency oscillator, equipped with a frequency modulator for sweeping the output frequency from maximum to minimum at a definite rate; and a marker oscillator which superimposes an interference pattern on the response curve at any desired position for locating values of frequency in the response curve.

Features: Two ranges of video output, giving unusual flexibility in adjustment of amplifier circuits; marker oscillator which provides direct frequency calibration on easy-reading, straight-line dial, permitting rapid location of any specific point in response curve; virtual freedom from distortion, insuring a high degree of accuracy; electronically regulated power supply, rendering the instrument independent of line-voltage variations.

Specifications:

Frequency Range:
 Video— { Band 1 (linear)..... 100-5000 kc
 { Band 2 (non-linear)..... 2000-7000 kc
 Marker—Overall (8 bands)..... 100-25,000 kc
 Output voltage, maximum:
 Video..... approx. 0.2 volt
 Marker..... approx. 0.1 volt
 Output impedance:
 Video..... 120 ohms
 Marker..... 2000 ohms
 Power supply..... 105-125 volts, 60 cycles
 Power consumption..... 50 watts
 Radiotrons... 1 RCA-6K8, 1 RCA-6J7, 1 RCA-6C5, 1 RCA-1851,
 2 RCA-874, 1 RCA-574; total 7
 Dimensions..... height 19 $\frac{3}{4}$ ", width 20 $\frac{1}{2}$ ", depth 9 $\frac{1}{4}$ "
 Weight..... 38 lbs.
 List Price (complete with tubes).....

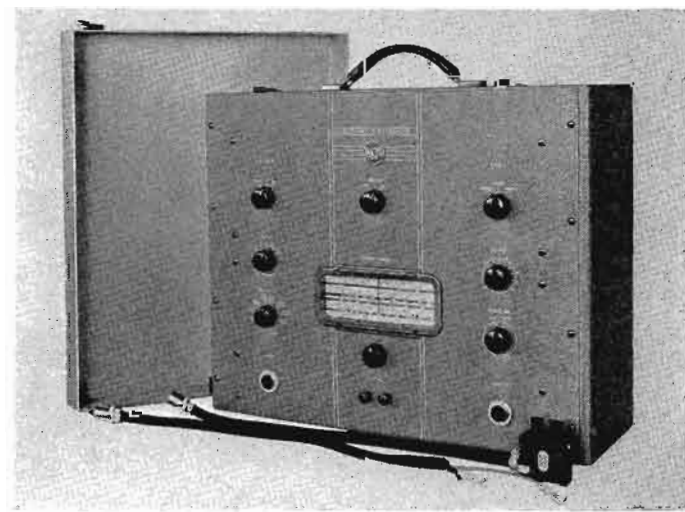

TELEVISION MEASURING EQUIPMENT

SYNCHRONIZING AND SWEEP APPARATUS

R-F AND I-F SWEEP OSCILLATOR Type 352-A

Applications: The Type 352-A permits rapid oscillographic alignment of television circuits, studies of the sound and picture channels, and general studies of all types of transmission circuits within its frequency range. It can also be employed as a general-purpose frequency meter.

Description: This unit contains two r-f oscillators, one covering the range of 40 to 90 megacycles for r-f alignment and the other heterodyning with the former to provide a range of 8 to 13 megacycles for i-f alignment.

A marker oscillator permits superimposition of an interference pattern on the response curve at any point for frequency-measuring purposes.

Features: Marker oscillator calibration referred to 2-mc internal crystal insuring absolute accuracy; two sweep ranges enabling separate study of sound- and picture-channel i-f circuits; output voltage adjustable over wide range.

Specifications:

Frequency range (center of sweep)	
R-F.....	40-90 mc
I-F.....	8-13 mc
Sweep range	
R-F.....	8 mc (accurate at channel points)
I-F.....	8 or 1 mc
Output voltage.....	R-F, 0.1 volt (max.); I-F, 0.3 volt (max.)
Output impedance	
R-F.....	100 ohms (balanced)
I-F.....	75 ohms (unbalanced)
Marker oscillator:	
Frequency range.....	R-F, 37-105 mc; I-F, 4.2-16.8 mc
Modulation frequency (from audio oscillator).....	400 cycles
Crystal oscillator frequency (fundamental).....	2 mc
Power supply.....	105-125 volts, 60 cycles
Radiotrons.....	1 RCA-955, 1 RCA-954, 1 RCA-1851, 3 RCA-6C5 1 RCA-6J7, 1 RCA-5W4; total 8
Dimensions.....	height 19 $\frac{3}{4}$ " , width 20 $\frac{1}{2}$ " , depth 9 $\frac{1}{4}$ "
Weight.....	44 lbs.
List Price (less tubes).....	

SWEEP RECTIFIER 353-A

A linear diode rectifier for checking response characteristics of wide-range amplifiers in conjunction with a sweep oscillator and cathode-ray oscillograph. This instrument, equally useful for single- or double-image operation, eliminates the need for a wide-range oscillograph for sweep-circuit applications.



Specifications:

Frequency range.....	100 kc to 150 mc
Voltage range.....	0.1-100 volts
Input circuit.....	25,000 ohms, 8 mmfd
Output circuit.....	250,000 ohms, 1,000 mmfd
Power supply.....	110-120 volts, 50-60 cycles
Power consumption.....	2 watts
Radiotrons.....	1 RCA-955
Dimensions.....	height 2 $\frac{1}{2}$ " , width 2 $\frac{7}{8}$ " , length 6 $\frac{1}{16}$ "
Weight.....	1 lb., 2 oz.
List Price (less tube).....	

The Type 301-A U-H-F Field-Intensity Meter is a wide-range instrument covering all channels assigned to television broadcasting. Description on page 100.

SYNCHRONIZING GENERATOR Type 560-A

Applications: This generator affords complete synchronizing signals for operation of television transmitters and receivers. It may be used on any RMA Std. 441-line system with a frame frequency of 30 and a field frequency of 60 (interlaced).

Description: Five different types of pulses are generated by a system of oscillators to accomplish Iconoscope driving and blanking, and Kinescope blanking and synchronizing. The blanking pulses effect return-line elimination, the driving pulses actuate the deflection and other circuits, and the synchronizing pulses insure proper synchronization of television receivers. Circuits are also included to insure proper locking with the power-supply frequency.

The Type 561-A auxiliary rack recommended for operation of this generator contains two regulated plate-supply units of the 580-A Type*, mounted in a cabinet rack.

Features: Special timing circuits maintaining extreme accuracy between leading edges of all pulses; improved locking circuit which synchronizes generator with 60-cycle power supply; conservative tube rating for long life.

Specifications of 560-A:

Power supply (Type 560-A):	110-120 volts, 60 cycles, 250 watts
(Obtained through 561-A Rack)	
Power supply (Type 561-A):	110-120 volts, 60 cycles, 850 watts
Power consumption	
(complete equipment).....	1100 watts
Radiotrons:	

Type 560-A:.....	15 RCA-6F6, 6 RCA-6H6, 1 RCA-6K7, 5 RCA-6L6, 5 RCA-6L7, 30 RCA-6N7; total 62
Type 561-A:.....	4 RCA-VR-150, 4 RCA-5U4-G, 10 RCA-6Y6-G, 2 RCA-1852; total 20

Dimensions (both racks) . . . height 82 $\frac{7}{8}$ " , width 20 $\frac{5}{16}$ " , depth 14 $\frac{3}{8}$ "
List Price 560-A and 561-A (both units, less tubes).....

*Type 580-A Plate Supply furnishes a potential of 300 volts d.c. for loads up to 400 ma. Description on page 94.

TELEVISION TEST CHARTS

These charts permit precise measurements of resolution in all or any portion of the screen, and independent determination of horizontal and vertical resolution, upper-frequency cutoff, and quality of half-tone transmission. Also available on 35-mm. motion-picture film.

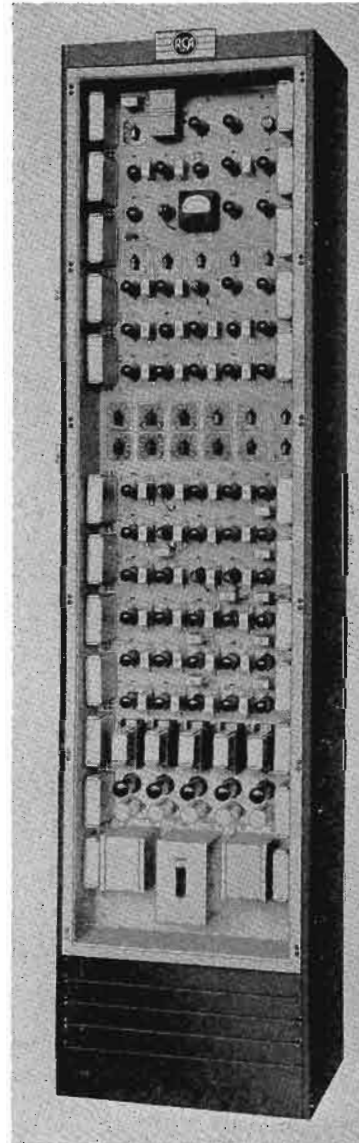
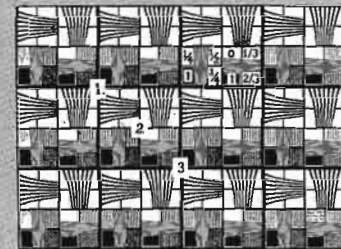

INDUSTRIAL MEASURING EQUIPMENT

PRESSURE-STUDY EQUIPMENT

ENGINE-PRESSURE MEASURING EQUIPMENT Type 314

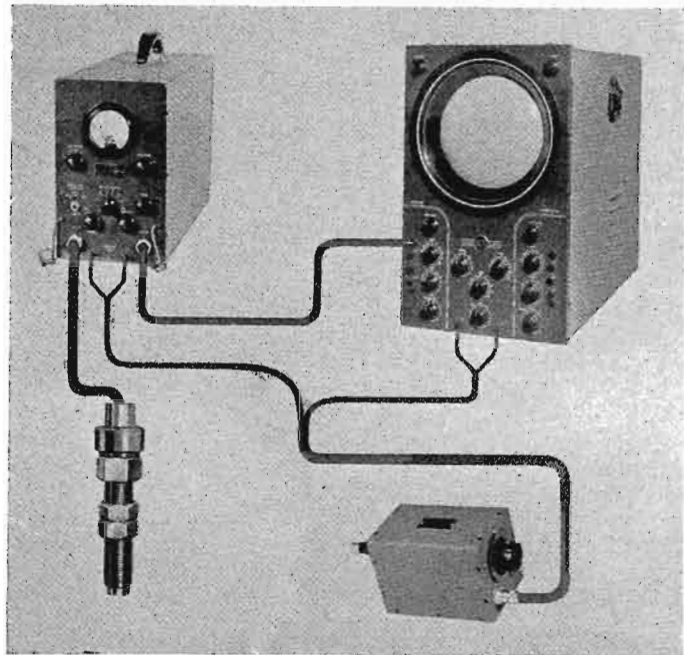

Description: The accuracy necessary in engine-pressure measurement has been difficult of attainment in the past, owing to the fact that the best indicating instruments available were of a mechanical nature. Such instruments were severely limited in accuracy and sensitivity principally by the inertia and friction of their moving parts. Spurious resonant effects often were present due to the use of springs, weights, and other devices. Thus the engineer striving for better engine performance was seriously handicapped since the best instruments he could obtain were incapable of following accurately the rapidly changing pressures he sought to study.

The answer to this need, however, is now found in the new RCA Type 314 Engine-Pressure Measuring Equipment, a diagrammatic layout of which is shown above.

The Type 314 Equipment comprises four separate units: (1) the Type 307-A Pressure-Conversion Unit which is inserted directly into a threaded hole in the engine cylinder, (2) the Amplifier, No. 9784, (3) the Type 304-A, No. 160, or the No. 9641 Oscillograph, and (4) the Synchronizer, No. 9786.

In operation, the pressure-conversion unit generates electrical impulses which vary proportionately with the pressure in the cylinder. These impulses, magnified by the amplifier, are applied to the vertical-deflection plates of the cathode-ray oscillograph.

The horizontal deflection or sweep of the oscillograph is generated internally, and is locked in step with the rotation of the engine shaft by means of the synchronizer. By adjusting the sweep speed of the oscillograph, the diagram may be made to represent 90°, 120°, 180°, 360°, or 720° of engine rotation.

With the exception of the oscillographs, which have already been presented in a separate section at the begin-

ning of this book, all the component units of the Type 314 Equipment are treated separately on this and the next page. A further detailed booklet on this equipment is also available on request.

PRESSURE-CONVERSION UNIT Type 307-A

The RCA Pressure-Conversion Unit, Type 307-A, is a device for the conversion of rapidly changing pressures into electrical impulses which may be amplified and pictured on the screen of a cathode-ray tube. This is accomplished by transmitting these pressures to quartz crystals, which, by virtue of their "piezo-electric" properties, generate on their surfaces electrical charges directly proportional to the pressures applied to them.

The pressure-conversion unit consists essentially of two quartz crystals securely mounted in a stainless-steel shell designed for insertion into a threaded hole in the cylinder wall. A piston at the lower or inner end receives the pressure and transmits it directly to the crystals. An electrical charge exactly proportional to this pressure is then imparted additively by both crystals to an electrode between the crystals, and conducted to the output cable. The other sides of the crystals are grounded to the holder, completing the circuit. A diaphragm holds the piston in place, at the same time permitting it to freely transmit the pressure variations to the crystals.

The charge produced on the crystals, besides being in exact proportion to the pressure exerted upon them through the piston, varies instantly with variations of the pressure, forming thus a most efficient indicator for these variations.

Each unit is given an individual calibration, which states its electrical output in terms of millivolts per 100 pounds of pressure per square inch. It thus becomes a relatively simple matter to measure engine pressures at any point in the pressure cycle, by measuring the electrical output of the pressure-conversion unit, and multiplying by this factor to determine the pressure.

The entire unit is of rugged construction, with stainless-steel construction of all parts exposed to air or burning gases. Practically impervious to moisture, the RCA Pressure-Conversion Unit is dependably accurate under extreme conditions. It is unaffected by temperatures up to 350° C., and capable of withstanding pressures of 5,000 pounds without damage to crystals or other parts.



Specifications:

No. 307-A1.....	threaded 5/8-18
No. 307-A2.....	threaded 18-1 1/2 mm.
Average output voltage per 100 lbs. pressure.....	0.003 volts
Maximum operating pressure.....	5,000 pounds per sq. inch
Maximum operating temperature.....	350° C.
Length of standard cable.....	.60 inches
Minimum engine speed (4-cycle engine).....	1000 r.p.m.
Length of unit.....	3 1/2 inches
List Price.....	

INDUSTRIAL MEASURING EQUIPMENT

PRESSURE-STUDY EQUIPMENT

AMPLIFIER No. 9784

Since the voltages generated by the quartz crystals of the pressure-conversion unit are extremely minute, they are insufficient in themselves to produce satisfactory deflection of the cathode-ray oscillograph. These signals must therefore be amplified by an amplifier whose response is linear over a wide frequency range since very irregular wave forms must be passed without distortion.

Description: The No. 9784 Amplifier is designed especially for this class of work. It is linear in amplification from two cycles to several thousand, and amplifies square waves as well as sine waves with equal fidelity. Its high input resistance amply meets the requirements for piezo-electric excitation. Input voltages may be amplified as much as 45,000 times without distortion, which is more than is usually required for pressure diagrams.

Also included in this amplifier is a means for measuring the input voltage generated by the quartz crystals by comparison of this voltage with a 60-cycle calibrating voltage which can be adjusted until the vertical deflection on the oscillograph screen is of the same height as the impulse from the pressure-conversion unit, showing the voltages to be equal. The voltage may then be read directly from a meter and attenuator mounted on the front panel.

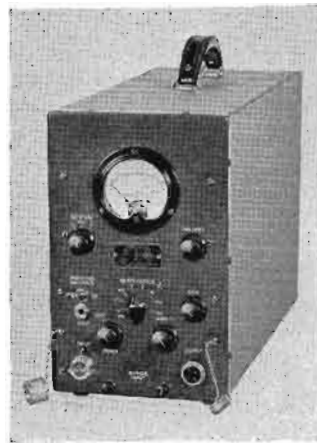

A control has been provided for superimposing a marker voltage on the pressure trace, when this is desired. The impulses for this voltage are provided by the No. 9786 Synchronizer.

Special precautions have been taken in the construction of this amplifier to prevent interference pickup from other sources such as ignition systems or nearby power lines. Special shielded input and output terminals are provided, and the entire instrument is enclosed in a metal cabinet.

Specifications:

Number of stages.....	3
Overall voltage gain.....	45,000
Overall frequency response.....	flat $\pm 6\%$, 2-17,000 cycles
Overall harmonic distortion—max.....	2nd, 2%; 3rd, 0.25%; 4th, negligible; 5th, 0.15%
Input voltage range, 1st stage.....	0.05-50 millivolts
D-C input resistance 1st stage.....	90 megohms
Gain-control range.....	100-1
Frequency response 2nd stage.....	flat $\pm 6\%$, 2-17,000 cycles
Input circuit.....	2 mfd. series capacitor, 0.390-megohm grid resistance
Input voltage range.....	5-500 millivolts
Calibrating voltage range.....	0-500 millivolts
Calibrating voltage frequency.....	power-source frequency
Output impedance.....	120,000-ohm plate load, 2-mfd. series capacitor
Output voltage (maximum).....	60 volts r.m.s.
Marker-impulse input voltage.....	1½ volts
List Price (complete with tubes).....	

SYNCHRONIZER No. 9786

Description: The No. 9786 Synchronizer is mechanically coupled to the engine crankshaft and generates voltage impulses for synchronizing the timing axis of the cathode-ray oscillograph with the shaft rotation. The unit contains a six-pole alternator which produces six impulses per revolution of the engine under test. This usually allows a sufficient range of choice for "framing" (centering) the pattern.

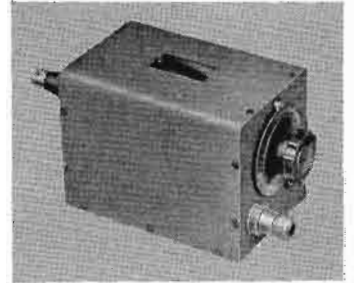

Another function of the unit is to provide a movable marker on the oscillograph trace for determining any point on the trace with respect to the angular position of the shaft.

Features: A calibrated dial which enables the observer to determine the angular position of the crankshaft corresponding to any point on the oscillograph trace; framing control for centering pattern on the oscillograph trace.

Specifications:

Synchronizing frequency.....	6 cycles per revolution
Synchronizing field adjustment.....	60°
Marker frequency.....	2 cycles per revolution
Marker-field adjustment.....	180°
Shaft coupling.....	¼"
Length of standard cable.....	74"
List Price.....	

VOLTAGE-REGULATING TRANSFORMER No. 9796

Applications: The No. 9796 Voltage-Regulating Transformer permits use of calibrated measuring equipments on 110-volt, 60-cycle power lines which are subject to severe fluctuations caused by heavy machinery, arc welders, and other factory equipment.

Description: Regulation is effected by variation of the inductance of a saturated reactor tuned by a fixed capacitor. The result is a practically constant output voltage.

Features: Automatic regulation over wide line-voltage range; freedom from moving parts insuring foolproof operation; convenient "plug-in" connections; totally enclosed construction insuring satisfactory service in industrial applications.



Specifications:

Line-voltage range.....	95-125 volts
Line frequency.....	60 cycles
Output voltage.....	115 (+2, -1) volts
Load ratings:	
(a).....	118 volt-amperes at 92.5% power factor (lagging)
(b).....	73 volt-amperes at 89.8% power factor (lagging)
Regulation (on above loads).....	$\pm 1\%$
List Price.....	

INDUSTRIAL MEASURING EQUIPMENT

VIBRATION-STUDY EQUIPMENT

VIBRATION PICKUP No. 9765

Applications: The No. 9765 Vibration Pickup is used with a cathode-ray oscillograph for a visual indication of frequency and wave form of mechanical vibrations in motors, machinery, aircraft equipment, buildings and foundations, and vibrations transmitted through materials.



Description: The pickup is firmly held or clamped to the object under test, causing a Rochelle Salt Crystal mounted within the pickup to generate an a-c voltage whose frequency and wave-form are proportional to the mechanical vibration.

Features: Independence of air-borne vibrations; viscoloid mounting to protect crystal unit from severe shocks; accurate calibration for computing vibration amplitudes.

Specifications:

Average output voltage0.25 volts per .001" movement at 250 cycles
 Average frequency range10-2700 cycles
 Frequency responseoutput proportional to square of frequency
 Maximum operating temperature125° F.
 Vibration axisright angle to face of pickup
 Cord length8 feet
 Dimensionsdiameter 3", depth 1½"
 Weight8 ounces
 List Price

VIBRATION-PICKUP CALIBRATOR No. 9787

Applications: The No. 9787 Vibration-Pickup Calibrator vibrates the No. 9765 Vibration Pickup at a standard amplitude of vibration and at power-line frequency. The output of the Vibration Pickup may then be measured on a cathode-ray oscillograph or peak voltmeter; and by means of a simple equation, the amplitude of the unknown vibration may readily be computed.

Description: The calibrator has a stud projecting from its side, to which the Vibration Pickup is mounted. The amplitude of vibration may be adjusted by means of a potentiometer to a standard value which may be found by observing the vibration of a resonant mechanical indicator contained in the unit. This indicator magnifies the vibration of the stud, and



produces a distinctive pattern at exactly the standard amplitude of vibration. The value of this standard vibration amplitude in thousandths of an inch is marked on the nameplate of each calibrator.

Features: Rugged construction for long lifetime of service; accurate individual testing of each unit, with standard amplitude of vibration marked on the nameplate, permitting quick and accurate calibration of Vibration Pickup.

List Price

ADDENDA—306-A FREQUENCY METER

USES OF 306-A FREQUENCY METER

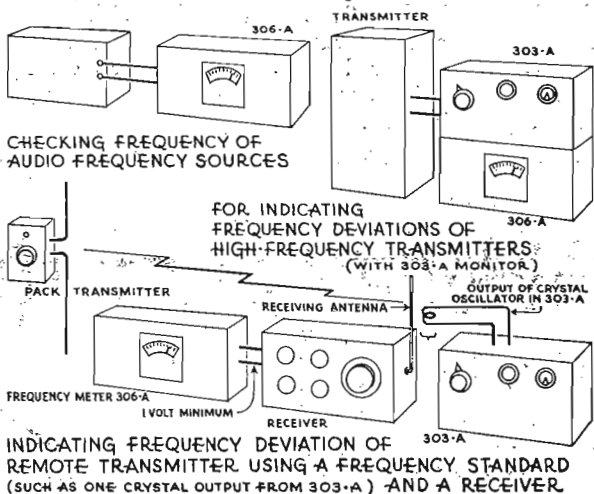

THE 306-A Instrument is an audio frequency indicating instrument which will read directly on a meter the number of cycles per second of the voltage applied to its input terminals. It contains an amplifier, a limiting circuit to make readings independent of input voltage as long as the minimum value is exceeded, a frequency discrimination circuit and a large indicating meter with ten multiplier scales covering a wide range of frequency readings up

to 50,000 cycles. It is provided with a self-contained power supply for A. C. operation and arrangements for operating a 5 milli-ampere recording meter.

The 306-A Frequency-meter may be used for laboratory checking of audio frequency generators or for calibration purposes. Another major use is for indicating the deviation from the assigned carrier frequency of a transmitter. Thus the 306-A forms an indicating instrument for the 303-A Frequency Limit Monitor and the combination will read frequency deviations (in the carrier range of 1.5 to 45 mc.) directly on a meter with an accuracy of 0.0025% or sufficiently accurate to conform to the FCC requirements for any class of high frequency service. When used with the 303-A, the neon lamp indicator of the latter may also be used as a warning to indicate that a preset tolerance has been exceeded. The 306-A may also be employed to advantage for monitoring remote low power transmitters by receiving the signal from the transmitter, beating it against a frequency standard, detecting the beatnote and feeding the difference frequency into the 306-A which will read its value. The receiver must be capable of producing an output of 2 volts or more over the audio range to be measured. In this way, pack transmitters may be checked.

Features: Accuracy of 2%, readings unusually independent of wave form, reads correctly over wide range of input voltages, high impedance input, large 6" indicating meter, 10 scale ranges for reading deviations accurately in the frequency range of 10 cycles to 50 kilocycles, regulated plate supply. Same panel height as 303-A.



V-CUT CRYSTALS



CRYSTAL UNITS

V - CUT CRYSTALS—CRYSTAL UNITS

Silica (SiO_2) is the general classification to which belongs the crystalline substance "Rock Crystal," more commonly known as "Quartz," from which, because of its unusual properties, the familiar quartz oscillator crystal is manufactured.

Raw Quartz or Rock Crystal as it appears in nature can be found on all continents. The more perfectly formed crystals required for scientific purposes are obtained from Brazil. The crystals are mined in a primitive fashion in the interior of the country, after which they are transported to the coast by pack animals. The ideal natural crystal consists of a six-sided prismatic body capped at each end by an apex. However, the usual crystal as we get it consists of a portion of the body and only one apex. This is due to mining procedures, in that the larger specimens are generally found protruding from clusters of smaller crystals bound by other rock formations. The usual method then is to break the crystal near the base of the protruding part. Selection of the finer pieces starts at the mine and continues all along the line of shipment, so that only the best optically clear crystals are received at the laboratory.

Because of the regular growth and formation of quartz crystals there exist certain axes of symmetry. First, one axis of three-fold symmetry, and second, three axes of two-fold symmetry. The axis of three-fold symmetry called the principal, optic, or "Z" axis, is an axis around which the crystal can be rotated in steps of 120° without distinguishing a change of appearance at these positions. The three axes of two-fold symmetry are axes about which the crystal can rotate 180° to restore the original pattern. These axes pass through the edges of the crystal and are normal to the principal axis.



A fine specimen of "Mother" Quartz Crystal.

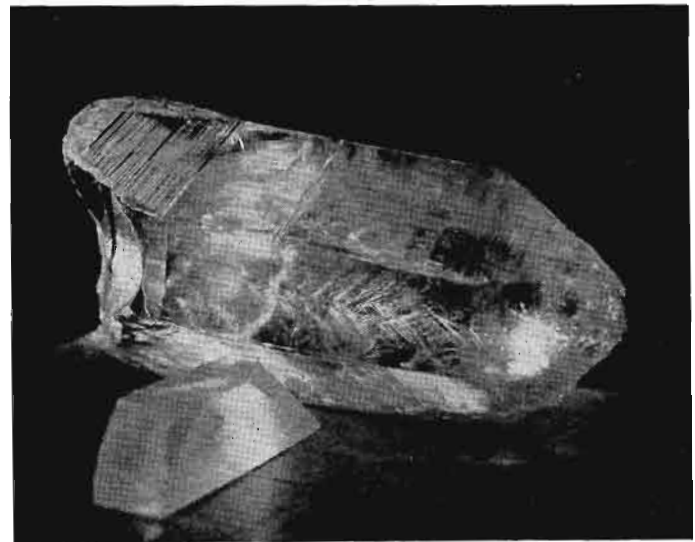

A good example of a bad specimen.

Crystal Characteristics

With respect to the quality of rock crystals it is essential for specimens to be reasonably free from defects such as cracks—foreign particles—"ghost crystals," which are well defined crystals appearing within the specimen—veils and needles, appearing as such because of microscopic air spaces—twinning—and impurities. Twinning in quartz crystals consists in a broad sense of two principal types. The first type, called stress-strain, is thought to have been caused by rapid temperature changes creating non-uniform temperature gradient which set up strains in the crystal line structure. The second type of twinning is called 180° twinning, in which the crystal structure is altered within by a reversal of form.

The uses of raw quartz are numerous and diversified—from jewelry to abrasives. It may be cut and polished for ornaments, prisms and lenses, and can be fused and drawn into threads for delicate instruments. But of most importance is the application of the piezo-electric property of quartz for pressure gauges, supersonic wave generators, and of special significance, for the control of radio frequencies, to which in recent years a great deal of consideration has been given. This characteristic of piezo-electricity as exhibited by quartz crystals is both interesting and phenomenal. It is an example of inter-conversion of mechanical and electrical energy in that when subjected to stresses, electrical charges appear on certain surfaces of the crystal, and conversely when placed in an electrical field, the specimen becomes mechanically distorted. In 1920 Cady discovered that quartz plates, because of the piezo-electric characteristic, could be employed to control the frequency of a self-oscillating circuit.

During the early stages of investigative work on crystals, it was found that when compression took



Examining a piece of rock quartz.

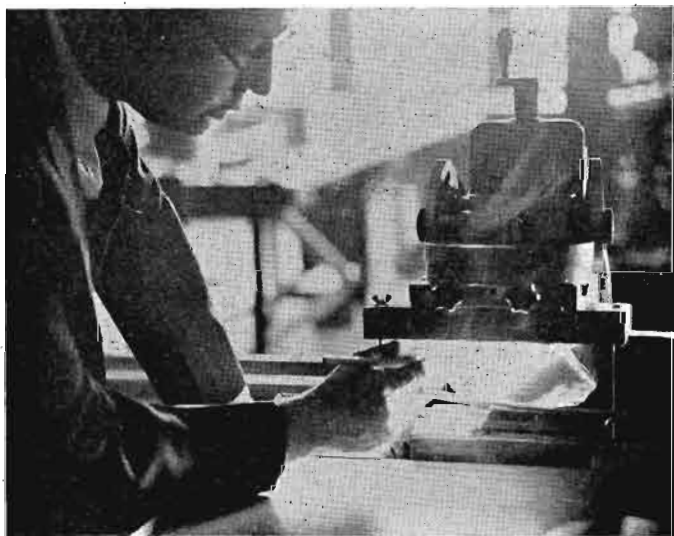

Precision cutting of natural quartz.



Determining preliminary cuts.

place along the two-fold axes of symmetry, electrical charges appeared on surfaces normal to these axes. Consequently, the three axes of two-fold symmetry were designated as the electric or "X" axes. Furthermore, it was discovered that elongation or compression at right angles to an electric axis and in the same horizontal plane, also produced electric charges on the same surfaces. These new axes of which there are three, by virtue of the three electrical axes, were designated as the mechanical or "Y" axes.

Crystal Cuts

Piezo-electric elements are cut and ground into various shapes such as long rods, flat discs, and thin plates. Thin plates are used most frequently in oscillating circuits. The plates are cut from the raw quartz in a wide variety of angles, the more common type of cuts being the "X" cut and the "Y" cut. The "X" cut quartz plate is an orientation about the optic or "Z" axis, the major surfaces being normal to an "X" axis, parallel to a "Y" axis and parallel to the "Z" axis. The "Y" cut crystal has its major faces normal to a "Y" axis and parallel to the "X" and "Z" axes.

The "X" cut crystal, in size, is usually one inch by one inch and anywhere from fifteen to three hundred mils in thickness, depending upon the frequency desired. The temperature coefficient of this cut is negative by about twenty cycles per megacycle per degree Centigrade. That is, as the temperature of the crystal is raised, the frequency drifts lower at the rate of twenty cycles per megacycle per degree rise in temperature. The "Y" cut is similar to an "X" cut crystal in size, but the temperature-coefficient is about plus eighty-five cycles per megacycle per degree Centigrade. In a like manner, as the temperature of the crystal is raised, the frequency rises at the rate of eighty-five cycles per megacycle per degree rise in temperature.



Interference patterns made by light falling on the lapped crystal as it rests against an optical "flat" assure flat plates.



Examining blanks for imperfections normally invisible.

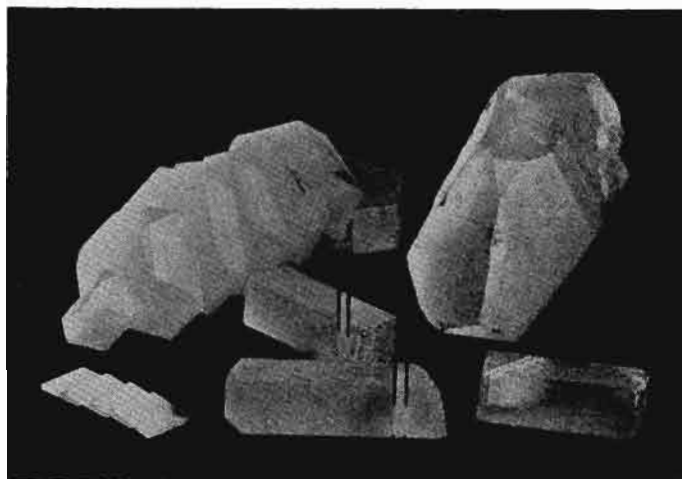

Illustrating the various cuts.

V-Cut Crystals

In recent years the search for zero temperature-coefficient crystals became quite active and of considerable importance. As a result of this search, RCA has developed the "V" cut quartz crystal. Unlike the other types of low-temperature-coefficient crystals, the "V" cuts are oriented away from the optic or "Z" axis and are not parallel to either the "X" or "Y" axes. The "V" cut type is a cut which assures minimum variation with temperature change, high output and a relatively great thickness in order to minimize the possibility of fracture. For broadcast service the temperature-coefficient is less than 1.5 cycles per million per degree Centigrade.

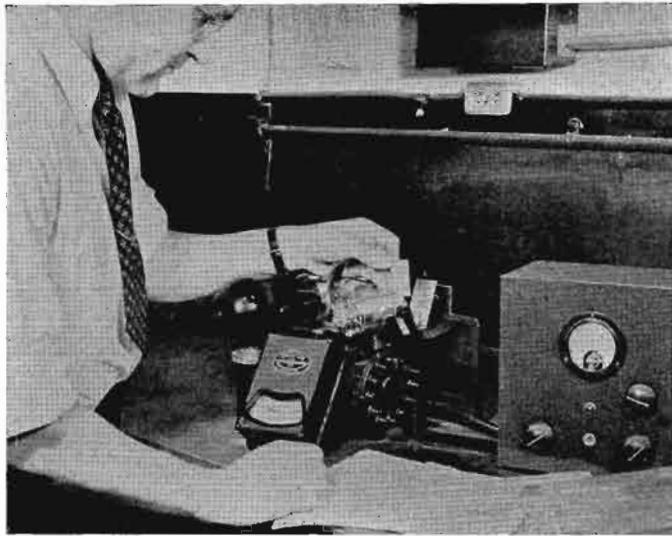

X-Ray Spectrometer Equipment

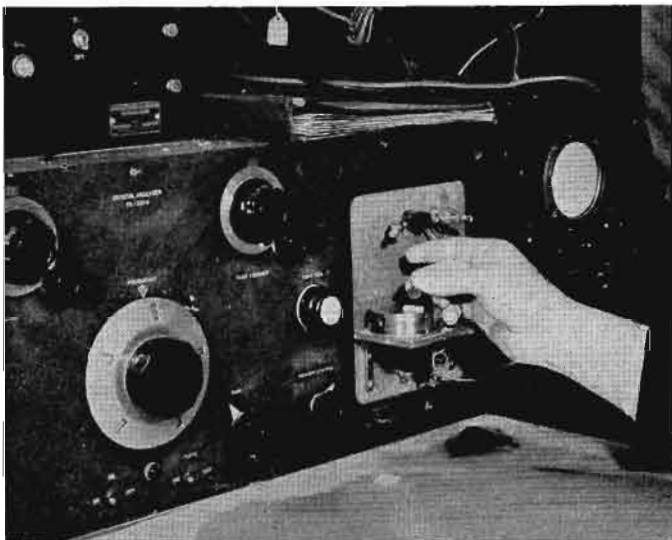

Testing filter crystals.



Natural quartz compared with the AVA-37 Holder.

Manufacturing V-Cut Quartz Crystal Oscillators

In the manufacturing of RCA V-cut quartz crystal oscillators only the highest grade of raw quartz is used. The specimen of raw quartz, commonly called the mother crystal, is first examined very carefully. It is coated with cedar oil, which brings out the defects more clearly, and removed to a dark room, where it is examined with elaborate optical equipment. In certain cases, a microscope is used to disclose the more obscure defects. After inspection the specimen is mounted horizontally and cut into sections approximately one inch thick. The cut faces of each are normal to the optic axis. The section is then checked for stress-strain and 180° twinning. Strained areas are masked and the clear areas are laid out into bars, which, as a convenience in cutting, may include some of the twinning portion blocked out in the section. The next step is to set up the bar and tilt in a direction such that the blanks may be cut at the specified angle.

The orientation is determined accurately by an X-ray method in which the angle between the principal face of the blank and a known atomic plane

is measured. Following this a reference face is made which is usually a hand grinding procedure, giving reasonable flatness for final X-ray measurements. If these measurements indicate the crystal orientation to be outside the predetermined limits, the blank must be re-ground until the tilt has been sufficiently altered to bring it within the limits. The surface of the reference face is then improved by light grinding and polishing, and with the aid of optical flats a high degree of flatness is obtained.

Once the reference face has been established all other dimensions are referred to it. Excess quartz may be removed by machine lapping or grinding, but when the blank reaches the final finishing stage it must of necessity be larger than required for the frequency specified. The reason is obvious, as no way has yet been found to add quartz to a blank and still have it function as an oscillator. The only salvation for an over-ground crystal is to set it aside as a blank which sometime might be suitable for a higher frequency crystal.

The final finishing is essentially a hand-grinding job. The operator must form the crystal to meet specifications as to frequency, activity, and temperature coefficient over a specified temperature range, which might be anything from -50° C. to $+100^{\circ}$ C. Many less expensive crystals are tested only from room temperature to $+50^{\circ}$ C. The crystal must be free from spurious oscillations, double frequencies and frequency jumps. The usual specifications call for a frequency temperature-coefficient of two parts per million per degree Centigrade, or better. In the final testing of the crystal, it is essential that the complete assembly of holder and crystal be checked over the specified range, as the mechanical assembly of holder parts may also have a temperature-coefficient affecting the performance of the unit. The recent tendency in final testing has been toward the use of automatic recording equipment.

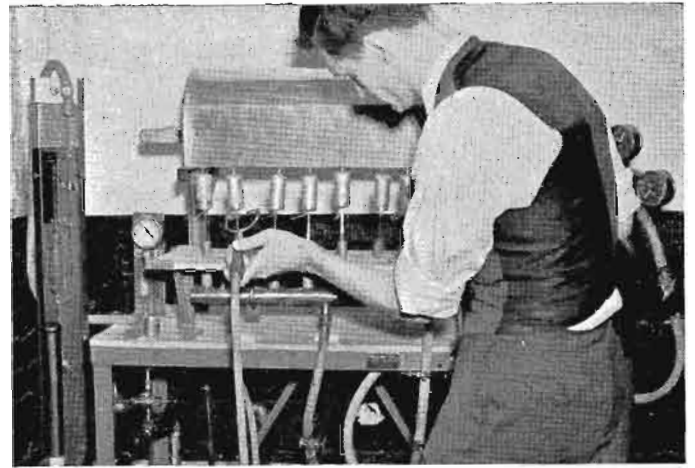

Sealing off the AVA-37 Holder.

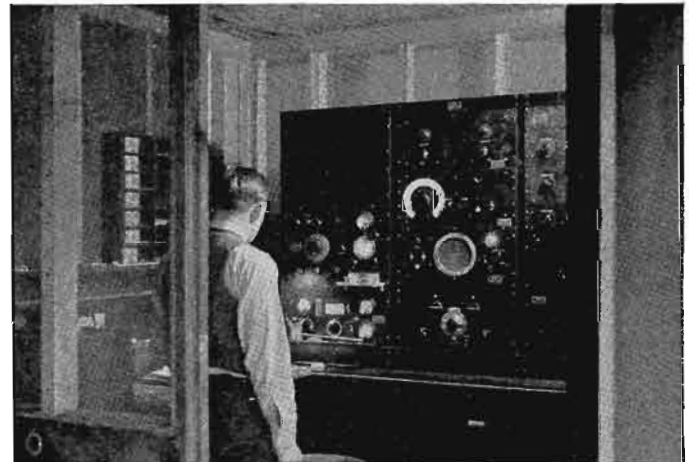

One of the many similar banks of crystal test equipment.

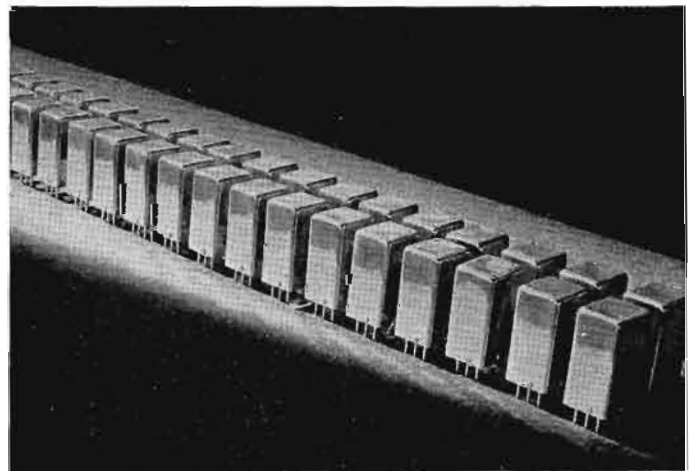

TMV-129-B Holders nearing completion.

Crystal units are generally pre-cooled and then placed in an oven, where they gradually reach the upper temperature limit required by the test. During this test, the frequency drift and oscillator grid current, as well as the temperature, is recorded automatically. The temperature-coefficient of the crystal can then be readily computed over the entire temperature range or any part of it, while the oscillator grid current gives an indication of the crystal activity over the same range. Having passed such tests, the units are then sealed and shipped.

A more recent development in the piezo-electric art is the production of "V" cut crystals having specially contoured faces, which makes it possible to provide much thicker and stronger crystals for a specific frequency. This is of particular importance in the frequencies ranging from 7,500 Kc. as high as 20,000 Kc., where ordinary crystals would be too thin to be manufactured commercially. However, it is necessary to use tuned plate circuits with this more rugged type of crystal.

Facilities have been provided to manufacture a

precision product, and all the steps have been geared to this high precision from the selection of raw quartz to the final crystal calibration. For this reason the RCA Mfg. Co., Inc., particularly welcomes the opportunity to furnish crystals to meet the most rigid specification. RCA has furnished all the crystals to meet its own stringent requirements for a number of years and has recently expanded its facilities to offer this service to others. Thus this service includes a wide experience with circuits in addition to unusual manufacturing and test facilities.

The organization has made every effort to standardize on a few types and mountings of crystal holders. By maintaining a relatively few active designs, the economic advantages of quantity production are realized and confusion in selecting the proper unit minimized. Since the holder influences the characteristics of the crystal, RCA prefers to furnish the complete unit; certain holders, however, are available for separate sale. The inconspicuous, yet all-important crystal unit, is truly a precision product of RCA.

Model AVA-10 Series

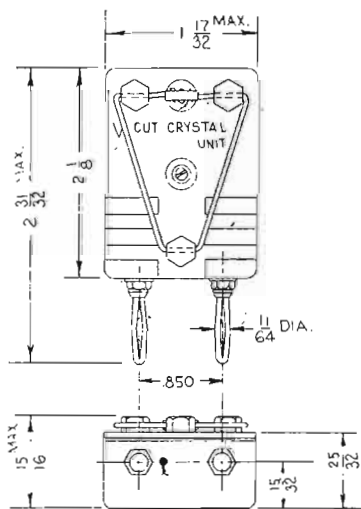

- RED DOT OR RING.

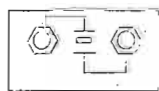

END VIEW SCHEMATIC

The RCA type AVA-10 series of crystals and crystal units have been developed to provide high quality at a low cost. However, nothing has been sacrificed in furnishing rugged construction to withstand the stringent requirements encountered in aircraft and commercial services. This is substantiated by the service these units are rendering in the field.

The holder body is moulded ceramic steatite with two terminals spaced at 0.850 inches, and each electrically connected to a crystal electrode of nickel silver. The crystal mounting is of the pressure air gap type and means for adjustment are provided so that optimum operating conditions are obtained. After final adjustment the holders are sealed against dust and moisture.

The AVA-10-B is provided with electrodes for crystals operating in the range of 1,715 Kc. to 10,250 Kc., while the AVA-10-C contains two electrodes specially designed for crystals operating from 10,250 Kc. to 20,000 Kc. The AVA-10-D and AVA-10-E are similar to the AVA-10-B and AVA-10-C respectively, differing only in temperature operating range.

Model AVA-11 Series

Designed to meet the requirements of commercial aviation and police equipment, the RCA type AVA-11 series of crystals and crystal units incorporate design features resulting from years of experience in this field.

They are characterized by small physical dimensions, correspondingly light weight and extreme ruggedness. The metal cover serves as a very effective shield which makes it practicable for use at high frequencies. The electrodes are of nickel silver and mounting of the crystal is of the pressure air gap type. A 6-volt or 12-volt heater, controlled by a bi-metallic disc type of thermostat is provided to maintain the crystal temperature above the dew point and to limit the temperature range through which the crystal must operate.

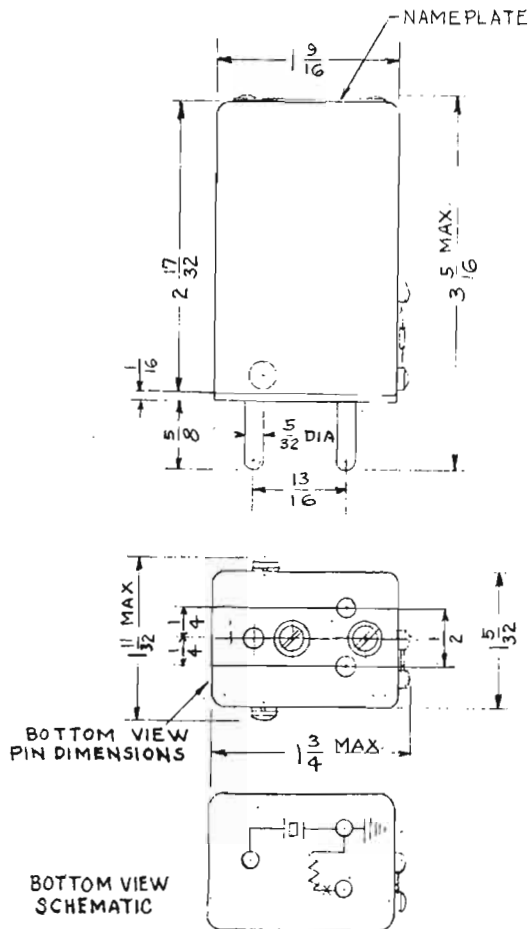
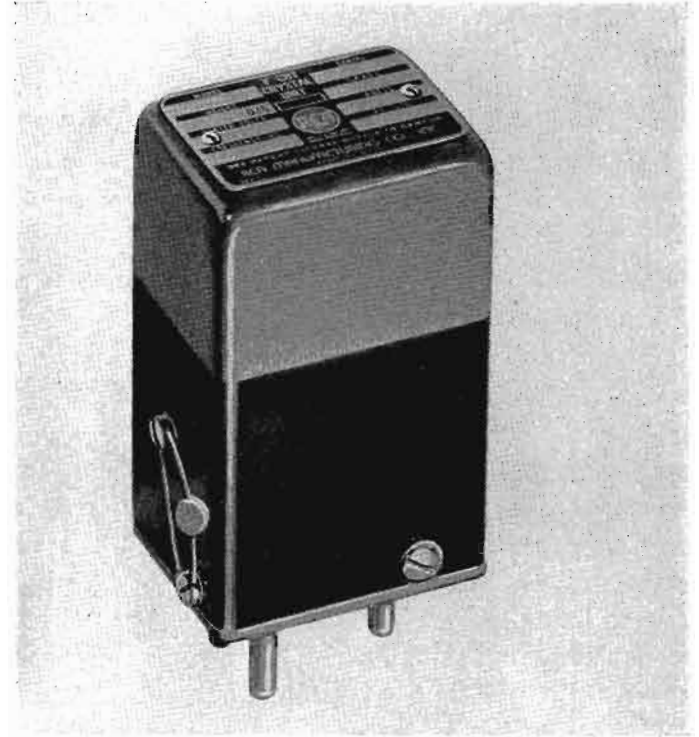

The AVA-11 and AVA-11-A holders cover the range from 1,715 Kc. to 10,250 Kc., and are identical, except that the former has a 12-volt heater unit while the latter incorporates a 6-volt heater. The heater terminals, as well as the electrode terminals, are brought out through the holder base in a three-prong arrangement, one prong being common to one electrode and one side of the heater.

The AVA-11-C covers the frequency range from 10,250 Kc. to 20,000 Kc. and contains a 6-volt heater. This type is designed primarily for police service. The AVA-11-D holder is designed for the frequency range from 1,715 Kc. to 10,250 Kc., contains a 12-volt heater as does the AVA-11, but also includes an electrode terminal on the side of the holder case.

The use of RCA "V" cut low temperature-coefficient quartz crystals in this type of holder makes for a precision product in every respect.

Model AVA-37 Series

This series of crystals and crystal holders is a recent achievement of the RCA laboratories. This type provides all the benefits of the standard low-temperature-coefficient "V" cut quartz plate, plus the new feature of mounting this element within an hermetically sealed, gas-filled metal envelope. The benefits obtained are of paramount importance where reliability of operation and stability of performance are essential under adverse conditions of dust and humidity.

Since the crystal element is mounted in an airtight chamber filled with an inert gas, it is impossible for dust particles or moisture to come in contact with the crystal or its electrodes. This valuable feature insures remarkably long, trouble-free service, a requirement of particular importance in the aviation and police services. The complete unit

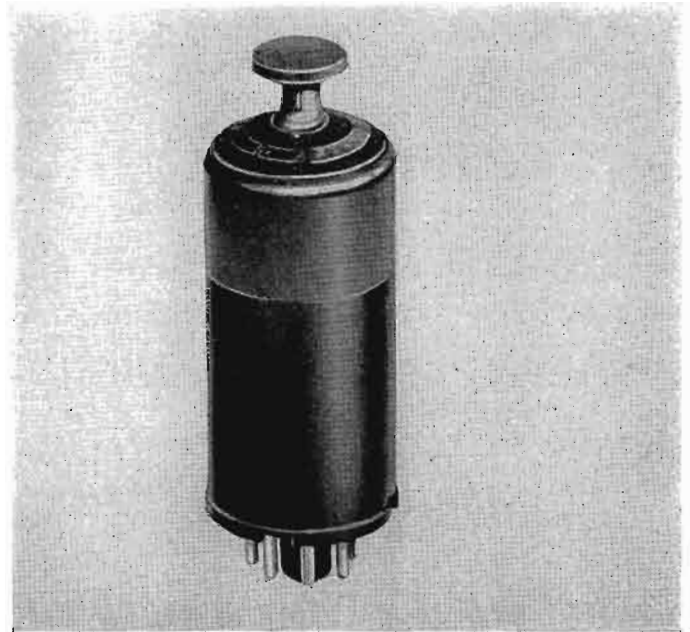

is small, no larger than an ordinary metal tube which it closely resembles, and is provided with a standard octal type base for mounting in an ordinary tube socket.

In this holder the crystal mounting is of the pressure air gap type, permitting the holder to be mounted in any position. The entire construction is extremely sturdy, amply able to withstand the most severe type of vibration or shocks liable to be encountered in any type of radio service. This holder has already been awarded a certificate of adoption by the Civil Aeronautics Authority, and it is fully anticipated that this new type holder will be in great demand when its distinctive features are fully recognized, particularly in view of the low price made possible by quantity production.

This unit is manufactured in two frequency ranges. The model AVA-37 covers the frequency range of 1,715 Kc. to 10,250 Kc. Model AVA-37-A covers 10,250 Kc. to 20,000 Kc.

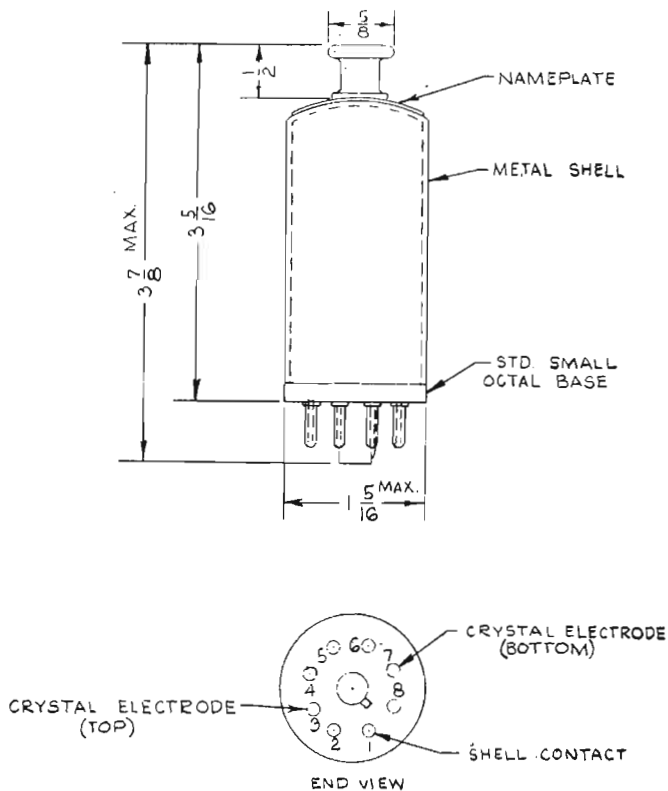

Model AC-95 Series

The RCA type AC-95 crystals and crystal units were designed to function in the low frequency range between 200 Kc. and 400 Kc. The crystals employed in this series, as in the others, are "V" cut low temperature-coefficient plates.

The holder bodies are of ceramic steatite, approximately two and one quarter inches in diameter by seven-eighths of an inch high. The monel metal bottom plate serves as the lower electrode and is connected to the lower of two side terminals, each of which is one-half inch long by five-sixteenths inch

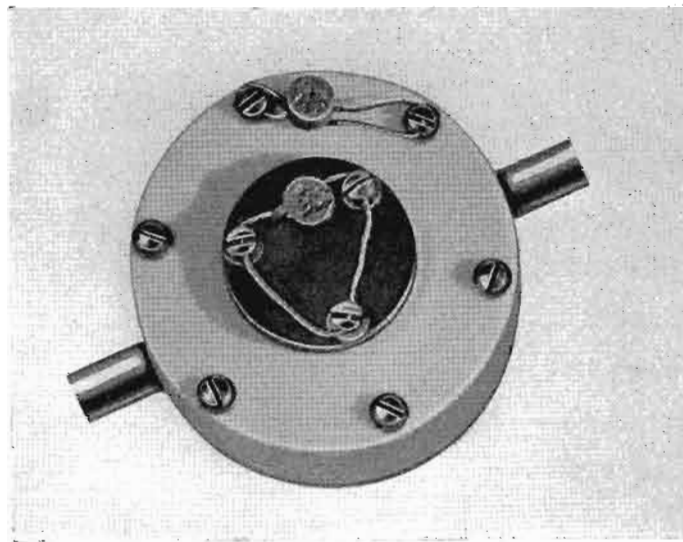

in diameter. The upper side terminal is connected internally to the top electrode.

The AC-95-A holder has the same external appearance as the AC-95, but internally is designed to provide a pressure air gap mounting for the "V" cut crystals which may thus cover the frequency range from 1,715 Kc. to 10,250 Kc., or even up to 20,000 Kc. if desired. The electrodes of this holder are made of nickel silver, similar to those employed in other RCA holders for this same frequency range.

In the AC-95-B holder the crystal mounting is of the fixed air gap type, the holder itself being of the same general appearance as the two types just described, but differing in the size of nameplate on the top surface. This crystal unit is designed to cover a frequency range from 200 Kc. to 2,000 Kc.

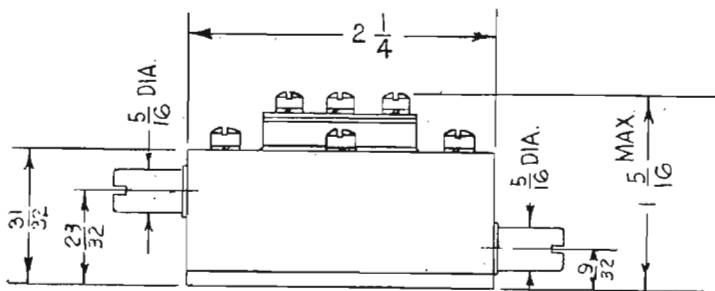
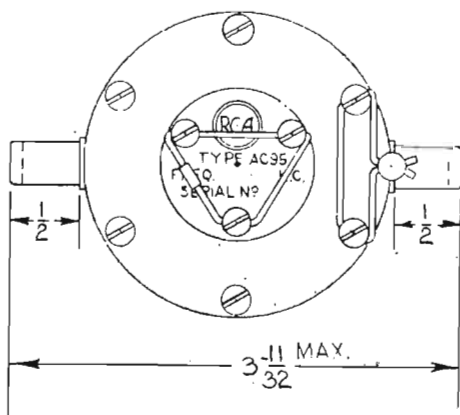

Models TMV-129-B and TMV-129-C

This series of crystals and crystal units is designed to provide frequency control for all transmitters operating in the frequency range from 200 Kc. to 3,000 Kc. It incorporates many patented features which provide a precision and quality of radio frequency control far in excess of the rigid requirements of the Federal Communications Commission for broadcast purposes. These units are widely used throughout the world and are particularly popular in the United States.

The 129-B holder is a shielded, self-contained unit of the plug-in type and contains a 15-watt, 115-volt heater element and a bi-metallic, compensated thermostat. The heater element and thermostat employed in this series are not just commercial articles adapted to a special application. On the contrary, the temperature control specifications of this holder are so rigid that RCA engineers have designed a special heater winding which surrounds

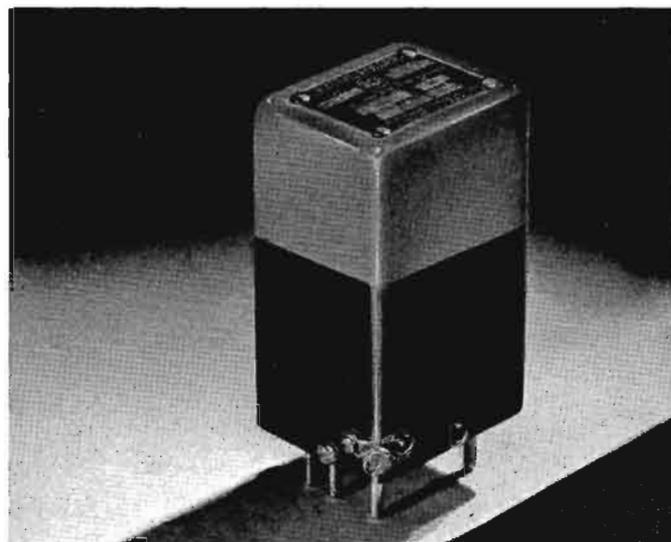

the crystal chamber on all four sides. It is very carefully insulated and shielded, and is energized directly from a 115-volt source (either A.C. or D.C.) through the controlling thermostat. The thermostat itself was especially developed for this application. No relays are used in this circuit, thereby reducing the possibility of failure. The crystal temperature in the holder is maintained at approximately 60 degrees Centigrade.

The crystal mounting is of the fixed air gap type and the electrodes are of monel metal. Connections to the two electrodes are brought out to two contacts of a special six-prong base which also provides connections to the metallic shields, heater winding and thermostat.

The RCA Type TMV-129-C differs from the TMV-129-B only in the type of crystal mounting employed. The pressure air gap type of mounting for use between 3,000 Kc. and 20,000 Kc. is used in the TMV-129-C. This type holder is a new product of RCA to extend all the benefits of the TMV-129-B throughout the high frequency range, thus providing precision frequency control up to twenty megacycles.

The material and workmanship of the TMV-129-B crystal unit is of such a high standard that RCA does not hesitate to guarantee that the assigned frequency will be maintained within ten cycles when used in the RCA UL-4292 oscillator. That is a degree of precision far exceeding any practical requirement.

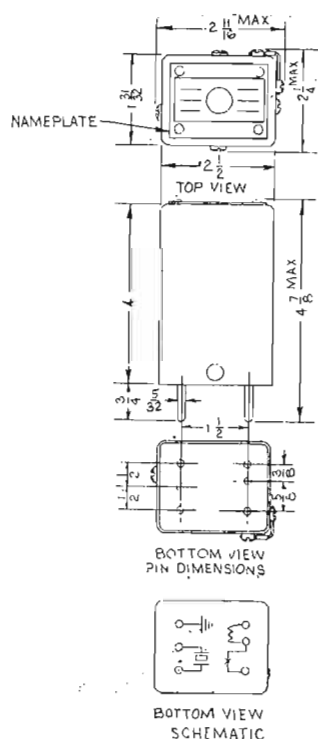

Model TMV-135 Series

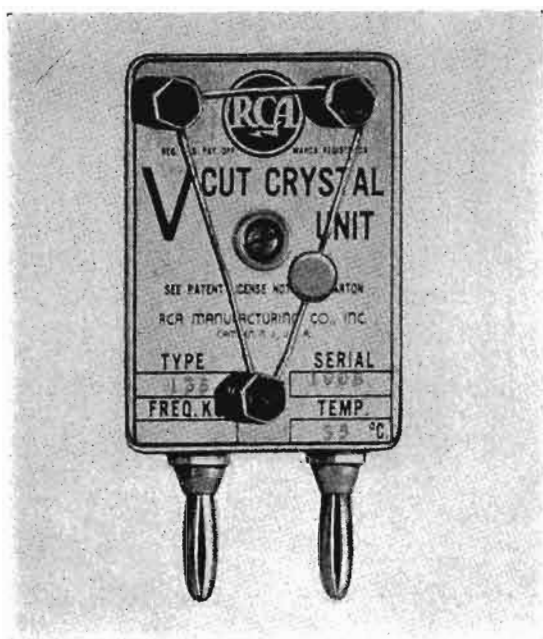

Amateurs have found these crystals and crystal holders excellently suited to their purposes. Commercial operators have also obtained excellent results with their use. This series is identical with the AVA-10 series, except that the two terminals are spaced three-fourths of an inch in accordance with standards set up for amateur use.

The holder body is of ceramic steatite, electrodes are of nickel silver and the crystal mounting is of the pressure air gap type. As in the more expensive type RCA holders, this unit uses the RCA "V" cut, low temperature coefficient crystals which are available for the 160, 80, 40, and the 20 meter amateur bands. Although primarily designed for amateur application, this holder is also extensively used for commercial purposes wherein the grinding tolerances and temperature-coefficient specifications are more rigid than required for amateur service.

The TMV-135 holders may be mounted in any position and may be used in a variety of oscillator circuits, so long as the radio frequency voltage and current do not exceed the guarantee ratings. Each crystal is carefully tested for accuracy, activity and stability before it is sealed into its holder.

The TMV-135-C is identical with the TMV-135-E, except for the electrodes and the crystal. In the higher frequency ranges special crystals are employed and differently shaped electrodes are used to provide maximum output. High quality at low cost is provided in this series of crystals and crystal units.

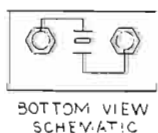
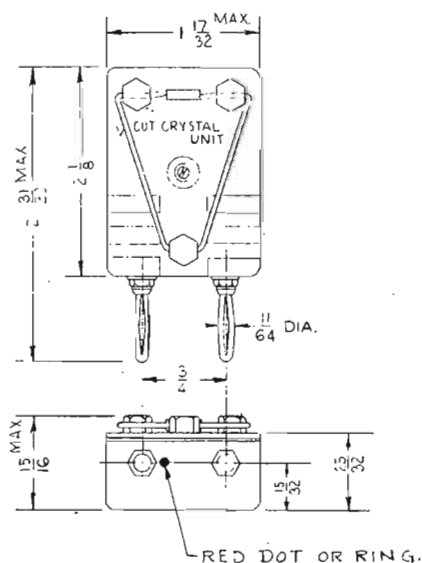

Crystals and Holders for Special Applications

A recent development of the RCA Manufacturing Company, of prime importance to the manufacturers of superheterodyne receivers, is the production of crystal units for intermediate or high frequencies. These units are the product of years of crystal research and manufacturing experience. Stability and a high "Q" factor are the most important characteristics of these units. Other outstanding features are their performance and simplicity.

These holders consist essentially of two similar moulded sections with an "X" cut or a "V" cut quartz crystal plate. The plate is inserted as the two halves are placed together and sealed. For intermediate frequencies the pocket formed by sealing the two moulded halves of the body to-

gether is just large enough to permit the crystal freedom of motion in any direction.

The complete units are so small and light that they may be mounted securely by the two leads which form the connections or by their electrode extensions. In performance, the use of RCA "V" cut quartz plates in these sealed holders provides high-quality, inexpensive crystal units, free from frequency "jumps" or "creeps."

Special types of crystal holders are constantly being designed and manufactured for special applications, and RCA will welcome the opportunity to submit designs and recommendations for crystals, crystal holders or complete units for any application in transmitters, receivers or test equipment.

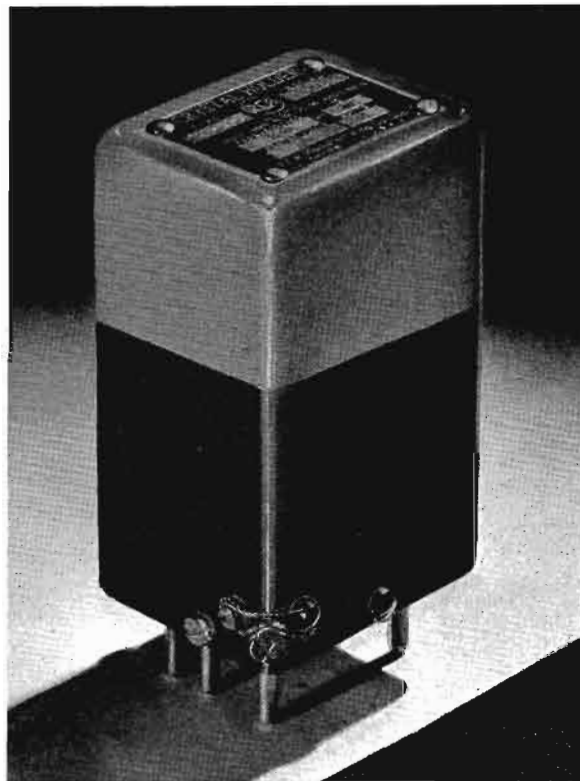

SPECIFICATIONS OF STANDARD CRYSTALS AND HOLDERS

Type	Frequency Range	Temperature Range	Accuracy	Heater	Electrodes	CRYSTAL Mounting
AVA-10-B	1,715 Kc.—10,250 Kc.	0° C.—+50° C.	Within 0.01% of specified freq.	None	Nickel Silver	Pressure Air Gap
AVA-10-C	10,250 Kc.—20,000 Kc.	0° C.—+50° C.	Within 0.01% of specified freq.	None	Nickel Silver	Pressure Air Gap
AVA-10-D	1,715 Kc.—10,250 Kc.	-40° C.—+55° C.	Within 0.015% of specified freq.	None	Nickel Silver	Pressure Air Gap
AVA-10-E	10,250 Kc.—20,000 Kc.	-40° C.—+55° C.	Within 0.015% of specified freq.	None	Nickel Silver	Pressure Air Gap
AVA-11	1,715 Kc.—10,250 Kc.	-40° C.—+55° C.	Within 0.015% of specified freq.	12 V. bi-metallic disc thermostat	Nickel Silver	Pressure Air Gap
AVA-11-A	1,715 Kc.—10,250 Kc.	-40° C.—+55° C.	Within 0.015% of specified freq.	6 V. bi-metallic disc thermostat	Nickel Silver	Pressure Air Gap
AVA-11-C	10,250 Kc.—20,000 Kc.	-40° C.—+55° C.	Within 0.01% of specified freq.	6 V. bi-metallic disc thermostat	Nickel Silver	Pressure Air Gap
AVA-11-D	1,715 Kc.—10,250 Kc.	-40° C.—+55° C.	Within 0.015% of specified freq.	12 V. Bi-metallic disc thermostat	Nickel Silver (side)	Pressure Air Gap terminal)
AVA-37	1,715 Kc.—10,250 Kc.	-40° C.—+55° C.	Within 0.015% of specified freq.	NONE	Nickel Silver	Pressure Air Gap
AVA-37-A	10,250 Kc.—20,000 Kc.	-40° C.—+55° C.	Within 0.015% of specified freq.	NONE	Nickel Silver	Pressure Air Gap
AC-95	200 Kc.—400 Kc.	-10° C.—+60° C.	As specified	NONE	Monel Metal	Micrometer Adjustable Air Gap
AC-95-A	2,000 Kc.—10,250 Kc.	0° C.—+60° C.	Within 0.01% of specified freq.	NONE	Nickel Silver	Pressure Air Gap
AC-95-B	200 Kc.— 400 Kc. 550 Kc.—2,000 Kc.	-10° C.—+60° C.	Within 0.01% of specified freq.	NONE	Monel Metal	Fixed Air Gap
TMV-129-B	500 Kc.—3,000 Kc.	60° C.	Zero beat *	115 V. 15 W. thermostat A.C. or D.C.	Monel metal	Fixed Air Gap
TMV-129-C	3,000 Kc.—20,000 Kc.	60° C.	As ordered depending on type of service	115 V. 15 W. thermostat A.C. or D.C.	Nickel Silver	Pressure Air Gap
TMV-135-C	1,715 Kc.—10,250 Kc.	+10° C.—+50° C.	Within 0.01% of specified freq. for commercial use	NONE	Nickel Silver	Pressure Air Gap
TMV-135-E	10,250 Kc.—20,000 Kc.	+10° C.—-50° C.	or within 0.1% for amateur use	NONE	Nickel Silver	Pressure Air Gap

*Zero beat implies that the crystal is calibrated in the actual circuit in which it is to be used. For this, a trimmer condenser is used for fine adjustment of frequency.

Faradon

CONDENSERS



Type 352 Case
Type 351 Case



Type 99 Case



Type 77 Case

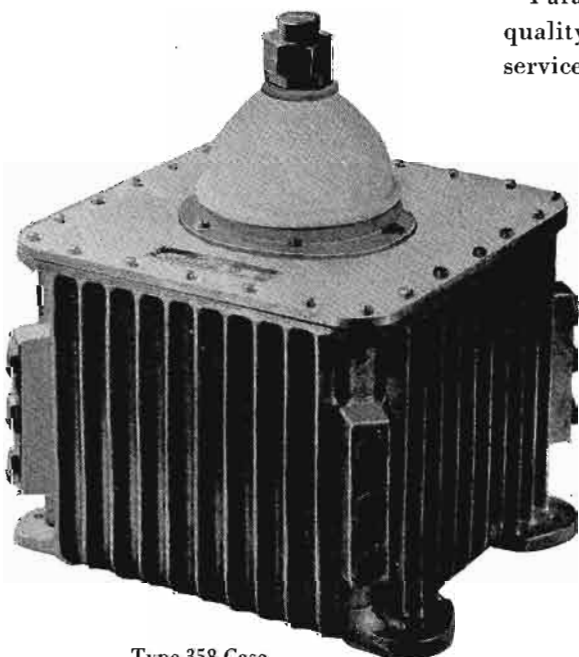

Type 358 Case



Type 13B Case

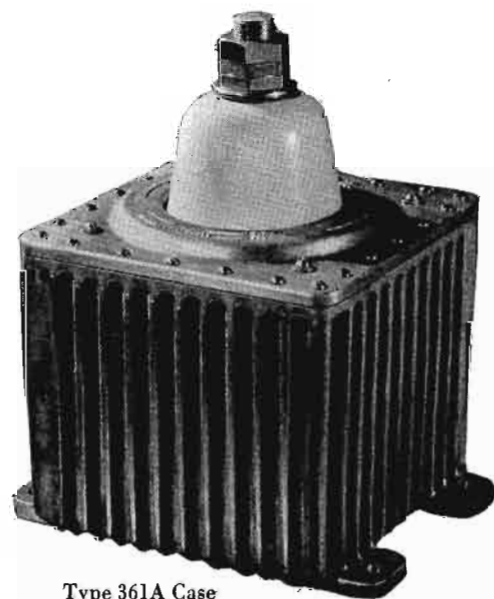

Type 361A Case

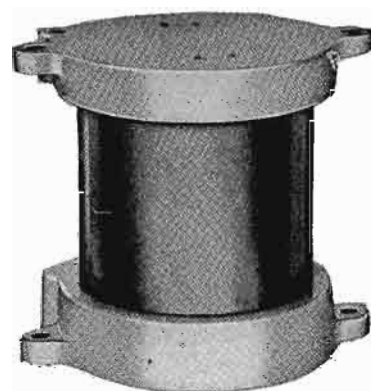

Type 111 Case



Type 140 Case

THE RCA MANUFACTURING COMPANY offers a complete line of Faradon mica power condensers. Many of the most generally used types and those used in RCA transmitters are carried in stock, ready for immediate delivery. Other types are partially fabricated and may be assembled into finished units in a reasonably short time.

The well equipped laboratories of the RCA Manufacturing Company perform a very thorough and complete analysis of the various materials used in Faradon condensers,—only the best grades of materials that have been carefully tested and approved are used.

These laboratories are also a proving ground for finished condensers and as a result of the persistent tests by RCA engineers and physicists, many valuable and substantial improvements are continually being made.

Faradon condensers are of superior quality and render long and dependable service.

Faradon

DIMENSIONS OF STANDARD TYPES OF CAPACITOR CASES

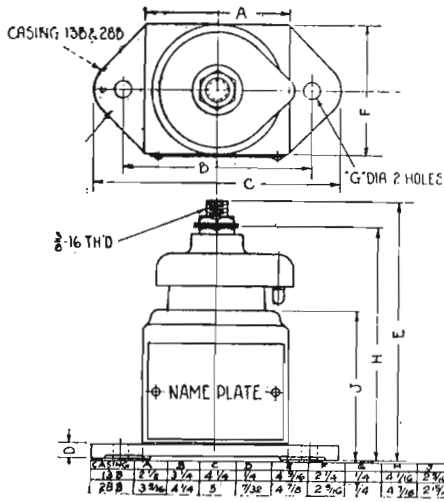

STANDARD FARADON condensers are listed on the succeeding pages; and condensers that are regularly carried in stock are marked with an asterisk.

Early models of condensers that are not shown in this listing may be supplied for replacement.

Dimensions of standard cases are shown on the adjoining drawings.

The following definitions are given in order to clarify the specifications included in the listing of standard condensers.

CAPACITY: The electrostatic capacity is stated in microfarads, accurate within a tolerance of plus or minus 5%.

REACTANCE: To assist engineers to select the proper capacity condenser, the reactance is given.

CURRENT: The current specified is the maximum for normal operation at ambient temperatures up to 60° centigrade. In modulated circuits assuming 100% modulation by a single audio frequency, the total current of 1.225 times the unmodulated current should not exceed the normal current rating of the condenser. By ambient temperature is meant the temperature of the air in the immediate vicinity of the condenser.

VOLTAGE: The maximum operating voltage is specified in terms of 60 cycles effective (RMS) or DC voltage. When two or more potentials are superimposed on a condenser the sum of all voltages should never exceed the rated voltage.

GUARANTEE: Faradon condensers are guaranteed against defective materials and workmanship for a period of 90 days. Authorization to return condensers for inspection and repair may be obtained from RCA Manufacturing Co., Camden, N. J. A report of operating conditions and reasons for returning must accompany the condenser.

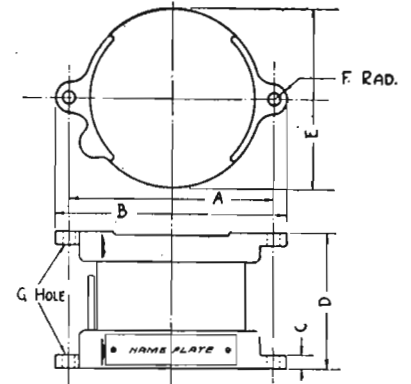

CASE	A	B	C	D	E	F	RAD.	G HOLE
77	5 3/8	4 1/4	3/8	4	5	1/2	377	
99	4 1/8	5	1/8	2 1/4	3 1/2	3/8	377	
111	5 3/4	4 1/2	3/8	5 1/4	5	1/2	377	

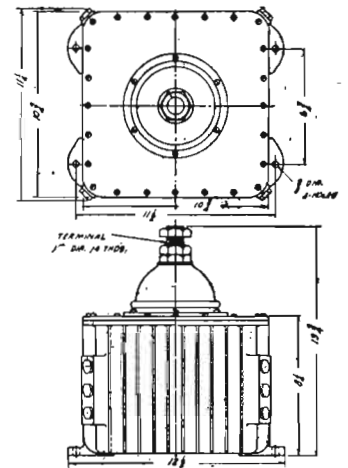
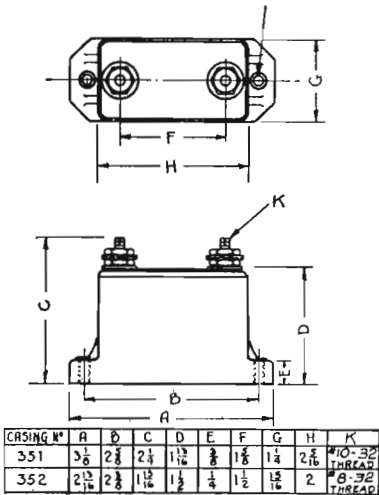

Casing 358

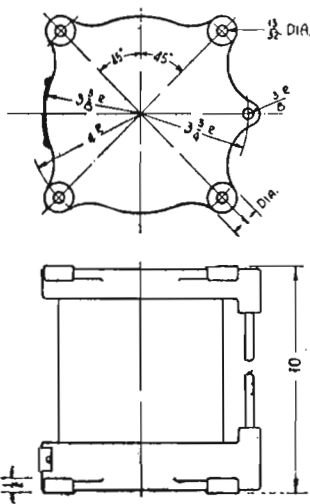

Casing 140

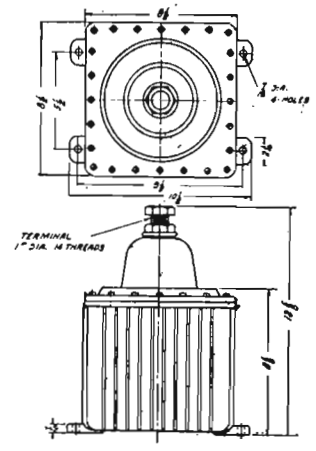

Casing 361A

Faradon

SPECIFICATIONS OF STANDARD MODELS OF MICA CAPACITORS

Capacity Microfarad	UC Model	Type Case	60 Cy. Eff. Voltage	Current Ratings		
				3000 Kc.	1000 Kc.	300 Kc.
1.0	Reactance.....			.053 ohms	.16 ohms	.53 ohms
	2979	111	1000	35 amps.	60 amps.	45 amps.
.5	Reactance.....			.11 ohms	.32 ohms	1.1 amps.
	2478	77	1000	25 amps.	60 amps.	40 amps.
.25	Reactance.....			.21 ohms	.64 ohms	2.2 ohms
	2980	351	250	16 amps.	20 amps.	16 amps.
	2981	99	1000	20 "	45 "	42 "
.1	Reactance.....			.53 ohms	1.6 ohms	5.3 ohms
	*2983	352	250	11 amps.	12 amps.	10 amps.
	2984	351	750	16 "	20 "	15 "
	2985	13B	1000	20 "	40 "	30 "
	2986	99	1000	20 "	40 "	35 "
	2988	77	2000	25 "	60 "	40 "
	3233	361A	6000	90 "	90 "	90 "
	3245	358	10000	100 "	100 "	100 "
.05	Reactance.....			1.1 ohms	3.2 ohms	10.6 ohms
	2989	352	500	11 amps.	10 amps.	8 amps.
	*2990A	351	1500	14 "	17 "	13 "
	2991	13B	1500	18 "	35 "	25 "
	2992	99	2000	20 "	40 "	35 "
	2446	77	3000	25 "	50 "	40 "
	2994	111	4000	35 "	60 "	45 "
	3234	361A	10000	90 "	90 "	90 "
	3246	358	15000	100 "	100 "	100 "
	.02	Reactance.....			2.7 ohms	8.0 ohms
2995		352	1000	11 amps.	10 amps.	7 amps.
*2996		351	2000	14 "	15 "	11 "
2997		13B	3000	18 "	21 "	16 "
2998		99	3000	20 "	35 "	24 "
2373A		77	3000	25 "	65 "	35 "
3000		111	5000	35 "	60 "	42 "
3235		361A	15000	90 "	90 "	90 "
3247		358	20000	100 "	100 "	100 "
.01		Reactance.....			5.3 ohms	15.9 ohms
	3202	352	2000	10 amps.	14 amps.	7 amps.
	*3004	351	2000	14 "	14 "	9 "
	3005	13B	3000	18 "	22 "	15 "
	*3006	99	4000	20 "	28 "	18 "
	2551A	77	6000	25 "	45 "	25 "
	3008A	111	10000	30 "	50 "	31 "
	3009A	140	15000	50 "	75 "	45 "
	3236	361A	20000	90 "	90 "	86 "
	3248	358	25000	100 "	100 "	96 "

* Stock Item

Faradon

SPECIFICATIONS OF STANDARD MODELS OF MICA CAPACITORS

Capacity Microfarad	UC Model	Type Case	60 Cy. Eff. Voltage	Current Ratings					
				3000 Kc.		1000 Kc.		300 Kc.	
.008	Reactance.....			6.6	ohms	19.9	ohms	66.3	ohms
	3011	352	1500	10	amps.	8	amps.	5	amps.
	3012	351	2000	13	"	12	"	7.5	"
	3013	13B	3000	18	"	20	"	13	"
	3014	99	4000	20	"	25	"	16	"
	3016	77	6000	25	"	36	"	22	"
	3017A	111	10000	30	"	42	"	27	"
	3018A	140	15000	65	"	65	"	40	"
	3237	361A	20000	90	"	90	"	76	"
	3249	358	25000	100	"	100	"	86	"
.006	Reactance.....			8.8	ohms	26.5	ohms	88.4	ohms
	3020	352	2000	9	amps.	7.5	amps.	4.5	amps.
	3021	351	3000	13	"	10	"	6.5	"
	3022	13B	5000	18	"	18	"	12	"
	3023	99	5000	20	"	23	"	14	"
	3025	77	6000	25	"	32	"	19	"
	3026A	111	10000	30	"	38	"	24	"
	3027	140	15000	45	"	60	"	36	"
	3238	361A	20000	90	"	90	"	66	"
	3250	358	25000	100	"	100	"	75	"
.005	Reactance.....			10.6	ohms	31.8	ohms	106	ohms
	*3029	352	2000	8.5	amps.	6.5	amps.	4	amps.
	3030	351	3000	12	"	9	"	6	"
	3031A	13B	5000	18	"	17	"	13	"
	3032	99	6000	20	"	21	"	13	"
	2663A	77	8000	30	"	30	"	20	"
	3034A	111	12000	35	"	36	"	22	"
	3035	140	15000	40	"	55	"	33	"
	3239	361A	20000	90	"	90	"	60	"
	3251	358	25000	100	"	100	"	68	"
.004	Reactance.....			13.3	ohms	39.8	ohms	133	ohms
	3037	352	2000	7	amps.	6	amps.	3.5	amps.
	*3038	351	3000	11	"	8.5	"	5.5	"
	*3039	13B	5000	17	"	15	"	9	"
	3040	99	6000	20	"	18	"	11.5	"
	*2360A	77	12000	27	"	27	"	16	"
	3042	111	15000	28	"	33	"	20	"
	3043	140	20000	35	"	50	"	30	"
	3240	361A	20000	90	"	90	"	52	"
	3252	358	30000	100	"	100	"	60	"
.003	Reactance.....			17.7	ohms	53.1	ohms	177	ohms
	*3045	352	2000	6.5	amps.	5	amps.	3	amps.
	3046	351	3000	10	"	8	"	5	"
	3047	13B	5000	15.5	"	13	"	8	"
	*3048	99	7000	20	"	16	"	10	"
	2374A	77	15000	22	"	25	"	16	"
	3050	111	15000	25	"	28	"	17	"
	3241	361A	20000	90	"	85	"	40	"
	3253	358	30000	100	"	96	"	52	"

* Stock Item

Faradon

SPECIFICATIONS OF STANDARD MODELS OF MICA CAPACITORS

Capacity Microfarad	UC Model	Type Case	60 Cy. Eff. Voltage	Current Ratings					
				3000 Kc.		1000 Kc.		300 Kc.	
.002	Reactance.....			26.5	ohms	79.6	ohms	265	ohms
	*3053	352	3000	5.5	amps.	4	amps.	2.5	amps.
	*3054	351	5000	8.5	"	6.5	"	4	"
	*3055A	13B	6000	13	"	10	"	6	"
	*3056	99	8000	16	"	14	"	8	"
	*2366	77	12000	21	"	20	"	12	"
	3222A	111	20000	22	"	22	"	13	"
	3198A	140	40000	40	"	38	"	21	"
	3242	361A	25000	65	"	65	"	30	"
	3254	358	30000	100	"	78	"	42	"
.0015	Reactance.....			35.4	ohms	106	ohms	354	ohms
	*3061	352	3000	5	amps.	3.5	amps.	2	amps.
	*3062A	351	5000	9	"	6	"	3.5	"
	3063	13B	5000	12	"	9	"	5	"
	3064	99	8000	14.5	"	11	"	7	"
	3066	77	12000	18	"	16	"	10	"
	*3067	111	16000	22	"	20	"	12	"
	3068A	140	40000	30	"	30	"	18	"
	3243	361A	25000	55	"	55	"	25	"
	3192A	358	30000	80	"	68	"	33	"
.001	Reactance.....			53.1	ohms	159	ohms	531	ohms
	*3070	352	3000	4.5	amps.	3	amps.	1.6	amps.
	*3071	351	5000	7	"	4.5	"	2.75	"
	3072	13B	5000	11	"	7	"	4	"
	*3073	99	10000	12	"	9	"	5.5	"
	*2325A	77	15000	16	"	16	"	9	"
	*3075	111	20000	18	"	17	"	10	"
	3076	140	40000	27	"	26	"	15	"
	3244	361A	25000	45	"	45	"	18	"
	3255	358	30000	60	"	55	"	22	"
.0008	Reactance.....			66.3	ohms	199	ohms	663	ohms
	3078	352	3000	4	amps.	2.5	amps.	1.5	amps.
	*3079	351	5000	6	"	4	"	2.5	"
	3080	13B	5000	9	"	6	"	3.5	"
	*3081	99	10000	11	"	8	"	5	"
	*2355A	77	20000	16	"	12	"	7	"
	*3083	111	25000	17	"	15	"	8.5	"
	3084	140	40000	26	"	24	"	13.5	"
	Reactance.....			88.4	ohms	265.3	ohms	884	ohms
3086	352	3000	3.5	amps.	2	amps.	1.2	amps.	
*3087	351	5000	5.5	"	3.75	"	2	"	
3088	13B	5000	8	"	5.5	"	3	"	
*3089	99	10000	10	"	7	"	4.25	"	
*2455	77	20000	12	"	10	"	6.5	"	
*3091	111	25000	14	"	12.5	"	7.5	"	
3092	140	40000	25	"	20	"	12	"	

* Stock Item



SPECIFICATIONS OF STANDARD MODELS OF MICA CAPACITORS

Capacity Microfarad	UC Model	Type Case	60 Cy. Eff. Voltage	Current Ratings					
				3000 Kc.		1000 Kc.		300 Kc.	
.0005	Reactance.....			106	ohms	318	ohms	1061	ohms
	*3094	352	3000	3	amps.	2	amps.	1	amps.
	*3095B	351	5000	6	"	4	"	2	"
	3096	13B	5000	7.5	"	5	"	2.5	"
	*3097	99	10000	9	"	7	"	4	"
	*2344	77	20000	12	"	10	"	6	"
	*3099	111	25000	13	"	11	"	6.5	"
	3100	140	40000	25	"	18	"	10	"
.0004	Reactance.....			133	ohms	398	ohms	1326	ohms
	3102A	352	3000	3	amps.	2	amps.	1	amps.
	3103	351	5000	4.5	"	3	"	1.5	"
	3104	13B	5000	6.5	"	4.5	"	2.25	"
	*3105	99	10000	9	"	6.5	"	3.5	"
	*3106	77	20000	12	"	8.5	"	5	"
	*3107	111	25000	13	"	10	"	6	"
	.0003	Reactance.....			177	ohms	531	ohms	1769
3108		352	3000	2.5	amps.	1.5	amps.	.75	amps.
*3109		351	5000	4	"	2.5	"	1	"
3110		13B	5000	5.5	"	3.5	"	1.8	"
*3111		99	10000	7.5	"	5	"	3	"
*3112		77	20000	11	"	7	"	4	"
3113A		111	30000	12	"	9	"	5	"
.0002		Reactance.....			265	ohms	795	ohms	2653
	3114	352	3000	2	amps.	1.2	amps.	.6	amps.
	*3115	351	5000	3.5	"	2	"	.7	"
	3116	13B	5000	4.5	"	3	"	1.2	"
	*3117	99	10000	6	"	4.5	"	2	"
	3118	77	20000	8	"	6	"	2.5	"
	*3119	111	30000	10	"	7	"	3	"
	2507	140	30000	18	"	12	"	4	"
.00015	Reactance.....			354	ohms	1061	ohms	3537	ohms
	*3120	352	3000	1.8	amps.	1	amps.	.45	amps.
	*3121	351	5000	3	"	1.5	"	.5	"
	3122	13B	5000	4	"	2.5	"	1	"
	3123	99	10000	6	"	4	"	1.6	"
	3124	77	20000	8	"	5	"	1.8	"
	*3125	111	30000	9	"	6	"	2.2	"
	.0001	Reactance.....			531	ohms	1592	ohms	5306
*3126A		352	3000	1.5	amps.	1	amps.	.3	amps.
*3127A		351	5000	2.5	"	1.5	"	.5	"
3128		13B	5000	3.5	"	2	"	.8	"
*3129A		99	10000	6	"	3.5	"	1.5	"
3130A		77	20000	7	"	4.5	"	1.7	"
3131A		111	35000	8.5	"	5	"	2	"
.00005		Reactance.....			1061	ohms	3184	ohms	10612
	3132	352	3000	1	amps.	.5	amps.	.15	amps.
	3133	351	5000	1.3	"	.6	"	.18	"

* Stock Item

MODEL NF AND MODEL T CONDENSERS

MODEL NF and Model T Faradon Condensers are useful in transmitters for by-pass purposes in plate circuits, filament circuits and across meters as well as for plate or grid coupling condensers in low power circuits. They are not designed for dissipating large amounts of power but are arranged for low loss operation and will meet the rigid requirements of radio frequency service.



FARADON MODEL NF

FARADON MODEL NF Condensers are mica dielectric capacitors sealed in molded bakelite of the very best grade of compound (BM-262), properly cured in molding to insure low losses at radio frequencies, and very low moisture absorption. After molding they are aged, then tested for voltage rating and accurately measured for capacity and rated with a standard tolerance of $\pm 10\%$. Closer tolerances may be obtained at a slightly higher cost.

This condenser offers a very broad selection of mounting. It may be mounted flat with screws through angular slots in the molding compound, which provides a liberal variance between the centers of the mounting holes. There is also a clear air space between the condenser terminals and surface to which it is mounted. The condenser may also be mounted vertically and secured to base by means of two threaded holes in the molding compound. 6-32 screw terminals are provided for electrical connection, as well as solder tabs.



FARADON MODEL T

FARADON MODEL T condensers are mica dielectric capacitors built up of thin films of the best grade of clear mica and securely compressed between two metal compression plates eyeletted together. A special treatment is given to this condenser to seal it against moisture absorption and climatic temperature changes thereby maintaining constant accurate capacity under severe operating conditions.

Since the dielectric of this condenser is principally mica, it is particularly suitable for very high radio frequency operation, having very low power factor losses. Large, flat terminals, projecting from opposite sides of this condenser, permit a soldered connection to be made, avoiding the possibility of terminal resistance.

MODEL NF			Microfarad Capacity	MODEL T		
Price	DC Working Voltage	DC Test Volts		DC Test Volts	DC Working Voltage	Price
.60	2500	5000	.00005	700	500	.40
.60	2500	5000	.0001	700	500	.40
.60	2500	5000	.0002	700	500	.40
.60	2500	5000	.0003	700	500	.40
.60	2500	5000	.0004	700	500	.40
.70	2500	5000	.0005	700	500	.50
.70	2500	5000	.0006	700	500	.50
.70	2500	5000	.0008	700	500	.50
1.00	2500	5000	.001	700	500	.60
1.00	2500	5000	.002	700	500	.60
1.00	2500	5000	.003	700	500	.70
1.00	2500	5000	.004	700	500	.70
1.40	1200	2500	.005	700	500	.75
1.70	1200	2500	.006	700	500	.75
1.70	1200	2500	.008	700	500	.85
1.70	1200	2500	.01	700	500	.85
.90	600	1000	.015			
1.40	600	1000	.02			
1.90	600	1000	.03			

Specify Type "BNF" Add .25 to above prices	Meter By Pass Terminals On Above Condensers	Specify Type "T4" Add .10 to above prices
---	---	--

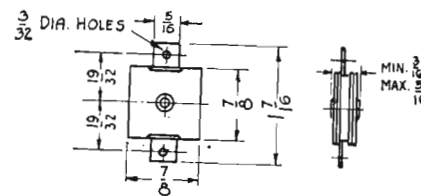
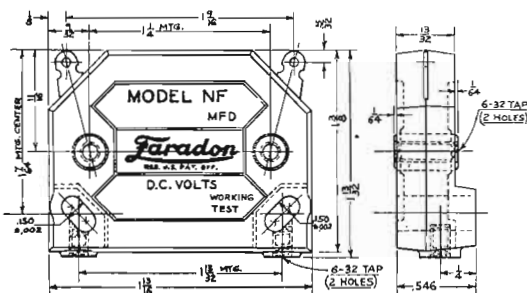

Faradon HIGH FREQUENCY CONDENSERS

FARADON high frequency condensers are built in low capacities usually required for Television, Facsimile and other high frequency power equipments. These condensers are of sulphur dielectric, one of the best known dielectrics, selected because of its very low power losses, and capable of operating at comparatively high temperatures. Another

very desirable feature is the small space they occupy, in comparison with other types of condensers at equal load and voltage.

In listing these condensers, no frequency is specified. The values listed apply for any frequency provided none of the other maximum values are exceeded in operation.



Case 366



Case 367

Model	MMFD Capacity	Max. KVA	Max. DC. or 60 cy. Eff. Voltage	Max. R. F. Eff. Voltage	Max. R. F. Current	Height "A" Dimen.
3287	20	50	20000	10000	10	4 ³ / ₄ "
3288	40	60	20000	10000	15	5 ⁵ / ₈ "
3260	50	75	20000	10000	20	6 ¹ / ₂ "
3289	60	75	20000	10000	20	6 ⁵ / ₈ "
3290	80	75	15000	7500	20	6 ¹ / ₂ "
3291	100	75	15000	7500	20	7 ¹ / ₂ "
CASE 366						
UC-3292	20	30	10000	5000	8	2 ¹¹ / ₁₆ "
3286	30	30	10000	5000	8	2 ⁷ / ₈ "
3278	40	40	10000	5000	10	3 ³ / ₈ "
3204	50	40	10000	5000	12	3 ⁷ / ₈ "
3294	60	40	10000	5000	12	4 ³ / ₁₆ "
3295	80	50	10000	5000	15	4 ³ / ₄ "
3296	100	50	10000	5000	15	5 ¹¹ / ₁₆ "
3297	120	50	10000	5000	15	6 ¹ / ₂ "
CASE 367						

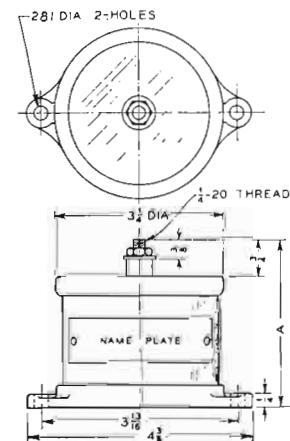
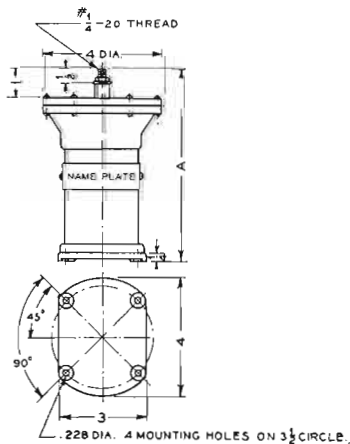



POWER TUBES AND SPECIAL PURPOSE TUBES

RCA power tubes are used extensively by broadcasting stations, commercial transmitting stations, in police radio equipment and aviation radio stations both in the United States and abroad. Their popularity is due to the care in manufacture, the sound engineering which lies behind them, the extensive tube making facilities in the factory and the close cooperation between tube engineers and the designers of transmitting equipment. The Radiotron Division is exclusively devoted to the manufacture of tubes and the research and engineering of this portion of the RCA Manufacturing Company is entirely for the benefit of applied electronics.

RCA power tubes receive careful tests under conditions which simulate the actual conditions of use. The selection of proper materials, efficient control of manufacture, elaborate processes devised to provide better performance, all contribute to long and satisfactory life. The RCA tube line is continually being improved so that the user obtains the best tubes possible. The introduction of lower priced power tubes and increases in life in others have saved considerable sums of money for the owners of transmitting equipment.

RCA Radiotron engineers have pioneered in many tube developments which have contributed to the radio art. The introduction of RCA screen grid power tubes and beam power tubes as well as special high frequency tubes has resulted in improved equipment performance. One of the best known power tubes, the RCA 862, was the highest power tube made available commercially. Used extensively in 50 KW transmitters, it has established an enviable reputation for long life and satisfactory service. The introduction of this tube (now the RCA 898) was a major factor in reducing the running costs of 50 KW equipment and in making this power economical for broadcasting stations.

RCA special purpose tubes have been designed for requirements where ordinary receiving type tubes would not fit. For ultra high frequency service, where microphonic noises cannot be permitted or where special characteristics are desirable, these tubes help to solve the problem. Other special purpose tubes include gas discharge valves, photocells, regulator tubes, cathode ray tubes and the like. Many of the special purpose tubes are used in RCA equipment in order to provide higher performance standards for the buyer.

RCA power tubes for broadcast stations use are sold through Transmitter representatives or, in all but the larger sizes, through tube distributors. Experimental tubes for new fields of application are available in many cases directly through the RCA Radiotron Laboratory at Harrison, N. J. Listings are provided on the following pages for power and special purpose tubes as well as for receiving type tubes commonly used in broadcasting equipment. Details or prices can be obtained from RCA field representatives or from the RCA Radiotron Division at Camden, N. J.

RCA TRANSMITTING RADIOTRONS

AIR-COOLED TYPES

Type	Description	Elec- trodes	Max. Plate Dissipation Watts	Cathode Type	Cathode Volts
203-A	R-F Power Amplifier, Oscillator, Class B Modulator.....	3	100	Filament	10.0
204-A	Oscillator, R-F Power Amplifier, Class B Modulator.....	3	250	Filament	11.0
211	R-F Power Amplifier, Oscillator, A-F Power Amplifier, Modulator...	3	100	Filament	10.0
800	R-F Power Amplifier, Oscillator, Class B Modulator.....	3	35	Filament	7.5
801	R-F and A-F Power Amplifier, Oscillator, Modulator.....	3	20	Filament	7.5
802	R-F Power Amplifier Pentode.....	5	10	Heater	6.3
803	R-F Power Amplifier Pentode.....	5	125	Filament	10.0
804	R-F Power Amplifier Pentode.....	5	40	Filament	7.5
805	R-F Power Amplifier, Oscillator, Class B Modulator.....	3	125	Filament	10.0
806	R-F Power Amplifier, Oscillator, Class B Modulator.....	3	150	Filament	5.0
807	Beam Power Amplifier.....	4	25	Heater	6.3
808	R-F Power Amplifier, Oscillator, Class B Modulator.....	3	50	Filament	7.5
809	R-F Power Amplifier, Oscillator, Class B Modulator.....	3	25	Filament	6.3
810	R-F Power Amplifier, Oscillator, Class B Modulator.....	3	125	Filament	10.0
813	Beam Power Amplifier.....	4	100	Filament	10.0
814	Beam Power Amplifier.....	4	50	Filament	10.0
830-B	Class B Modulator, R-F Power Amplifier, Oscillator.....	3	60	Filament	10.0
831	Oscillator, R-F Power Amplifier.....	3	400	Filament	11.0
832	Push-pull R-F Beam Power Amplifier.....	4**	15	Heater	6.3**
833	R-F Power Amplifier, Oscillator.....	3	300	Filament	10.0
834	R-F Power Amplifier, Oscillator.....	3	50	Filament	7.5
835	R-F Power Amplifier, Oscillator, A-F Power Amplifier, Modulator...	3	100	Filament	10.0
837	R-F Power Amplifier Pentode.....	5	12	Heater	12.6
838	Class B Modulator, R-F Power Amplifier, Oscillator.....	3	100	Filament	10.0
841	R-F Power Amplifier, Oscillator, A-F Voltage Amplifier.....	3	15	Filament	7.5
842	A-F Power Amplifier, Modulator.....	3	12	Filament	7.5
843	Power Amplifier, Oscillator.....	3	15	Heater	2.5
844	Screen-Grid R-F Power Amplifier.....	4	15	Heater	2.5
845	Modulator, A-F Power Amplifier.....	3	75	Filament	10.0
849	Modulator, A-F Power Amplifier, R-F Power Amplifier, Oscillator...	3	400	Filament	11.0
850	Screen-Grid R-F Power Amplifier.....	4	100	Filament	10.0
851	Modulator, A-F Power Amplifier, R-F Power Amplifier, Oscillator...	3	750	Filament	11.0
852	Oscillator, R-F Power Amplifier.....	3	100	Filament	10.0
860	Screen-Grid R-F Power Amplifier.....	4	100	Filament	10.0
861	Screen-Grid R-F Power Amplifier.....	4	400	Filament	11.0
865	Screen-Grid R-F Power Amplifier.....	4	15	Filament	7.5
891-R	R-F Power Amplifier, Oscillator, Modulator ($\mu = 8$).....	3	5,000	2-phase Filament	11.0 Per Phase
892-R	Oscillator, R-F Power Amplifier, Class B Modulator ($\mu = 50$).....	3	5,000	2-phase Filament	11.0 Per Phase

** Per Unit.

WATER-COOLED TYPES

Type	Description	Elec- trodes	Max. Plate Dissipation Watts	Cathode Type	Cathode Volts
207	Oscillator, R-F Power Amplifier, Class B Modulator.....	3	10,000	Filament	22.0
520-B	Oscillator, R-F Power Amplifier.....	3	5,000	Filament	22.0
846	Oscillator, R-F Power Amplifier.....	3	2,500	Filament	11.0
858	Oscillator, R-F Power Amplifier.....	3	20,000	Filament	22.0
862	Oscillator, R-F Power Amplifier, Class B Modulator.....	3	100,000	Filament	33.0
887	UHF Power Amplifier, Oscillator ($\mu = 10$).....	3	1,000	Filament	11.0
888	UHF Power Amplifier, Oscillator ($\mu = 30$).....	3	1,000	Filament	11.0
891	R-F Power Amplifier, Oscillator, Modulator (Supersedes Type 848) ..	3	6,000	2-phase Filament	11.0 Per Phase
892	Oscillator, R-F Power Amplifier, Class B Modulator (Supersedes Type 863).....	3	10,000	2-phase Filament	11.0 Per Phase
893	Oscillator, R-F Power Amplifier, Class B Modulator.....	3	20,000	3-phase Filament	17.3 Per Phase
898	Oscillator, R-F Power Amplifier, Class B Modulator.....	3	100,000	3-phase Filament	30.0 Per Phase
1652	Oscillator, R-F Power Amplifier.....	3	5,000	Filament	14.5

RECTIFIERS

			Max. Peak Inverse Volts		
217-A	Half-Wave, High-Vacuum.....	2	3,500	Filament	10.0
217-C	Half-Wave, High-Vacuum.....	2	7,500	Filament	10.0
836	Half-Wave, High-Vacuum.....	2	5,000	Heater	2.5
857-B	Half-Wave, Mercury-Vapor (Supersedes Type 857).....	2	22,000	Filament	5.0
866	Half-Wave, Mercury-Vapor.....	2	7,500	Filament	2.5
866-A	Half-Wave, Mercury-Vapor.....	2	10,000	Filament	2.5
869-A	Half-Wave, Mercury-Vapor.....	2	20,000	Filament	5.0
870	Half-Wave, Mercury-Vapor.....	2	16,000	Heater	5.0
871	Half-Wave, Mercury-Vapor.....	2	5,000	Filament	2.5
872	Half-Wave, Mercury-Vapor.....	2	7,500	Filament	5.0
872-A	Half-Wave, Mercury-Vapor.....	2	10,000	Filament	5.0
1616	Half-Wave, High-Vacuum.....	..	5,500	Filament	2.5

RCA SPECIAL PURPOSE TUBES AND ACCESSORIES

CATHODE-RAY TYPES

			Max. Anode No. 2 Volts		
3AP1/906-P1	3 in., Electrostatic Deflection.....	..	1,500	Heater	2.5
3AP4/906-P4	3 in., Kinescope, Electrostatic Deflection, Medium-Persistence White Phosphor.....	..	1,500	Heater	2.5
5BP1/1802-P1	5 in., Kinescope, Electrostatic Deflection, Medium-Persistence Green Phosphor.....	..	2,000	Heater	6.3
5BP4/1802-P4	5 in., Kinescope, Electrostatic Deflection, Medium-Persistence White Phosphor.....	..	2,000	Heater	6.3
9AP4/1804-P4	9 in., Kinescope, Medium-Persistence White Phosphor.....	..	7,000	Heater	2.5
12AP4/1803-P4	12 in., Kinescope, Medium-Persistence White Phosphor.....	..	7,000	Heater	2.5

CATHODE-RAY TYPES—Continued

Type	Description	Electrodes	Max. Anode No. 2 Volts	Cathode Type	Cathode Volts
902	2 in., Electrostatic Deflection, High-Vacuum	4	600	Heater	6.3
904	5 in., Electrostatic-Magnetic Deflection, High-Vacuum	5	4,600	Heater	2.5
905	5 in., Electrostatic Deflection, High-Vacuum	4	2,000	Heater	2.5
907	5 in., Electrostatic Deflection, High-Vacuum, Short-Persistence Screen	4	2,000	Heater	2.5
908	3 in., Electrostatic Deflection, High-Vacuum, Short-Persistence Screen	4	1,500	Heater	2.5
909	5 in., Electrostatic Deflection, High-Vacuum, Long-Persistence Screen	4	2,000	Heater	2.5
910	3 in., Electrostatic Deflection, High-Vacuum, Long-Persistence Screen	4	1,500	Heater	2.5
913	1 in., Electrostatic Deflection, High-Vacuum, Low-Voltage	4	500	Heater	6.3
914	9 in., Electrostatic Deflection, High-Vacuum	5	7,000	Heater	2.5
1849	Iconoscope (for pick-up from motion picture film)	..	1,200	Heater	6.3
1850	Iconoscope (for direct pick-up of scene)	..	1,200	Heater	6.3
1899	5 in., Monoscope, Electromagnetic Deflection	..	1,500	Heater	2.5

RECTIFIERS—FOR CATHODE-RAY TUBES

			Max. Peak Inv. Volts		
2V3G	Half-Wave, High-Vacuum	2	16,500	Filament	2.5
878	Half-Wave, High-Vacuum	2	20,000	Filament	2.5
879	Half-Wave, High-Vacuum	2	7,500	Filament	2.5
884	Gas-Triode for Cathode-Ray Sweep-Circuit Control	3	300	Heater	6.3
885	Gas-Triode for Cathode-Ray Sweep-Circuit Control	3	300	Heater	2.5

PHOTOTUBES

			Max. Anode Volts		
868	Gas Phototube	2	90
917	Vacuum Phototube	2	500
918	Gas Phototube (High Sensitivity)	2	90
919	Vacuum Phototube	2	500
920	Twin Phototube (Gas Type)	4	90
921	Gas Phototube (Cartridge Type)	2	90
922	Vacuum Phototube (Cartridge Type)	2	500
923	Gas Phototube (High Sensitivity)	2	90
924	Gas Phototube (End Type, Intermediate Base)	2	90
925	Vacuum Phototube (Octal Base)	2	250
926	Vacuum Phototube (Rubidium Surface, Cartridge Type)	2	250
927	Gas Phototube (Small type, 3-pin base)	2	90

MISCELLANEOUS TYPES

			Max. Plate Dissipation Watts		
6AC7/1852	Television Amplifier Pentode (Single Ended Type)	5	Heater	6.3
6AB7/1853	Television Amplifier Pentode (Single Ended Type)	5	Heater	6.3
VR105/30	Voltage Regulator (Glow Discharge)	2
VR150/30	Voltage Regulator (Glow Discharge)	2
840	R-F Pentode	5	Filament	2.0
864	Amplifier Triode (Low-Microphonic Design)	3	Filament	1.1
954	Detector Amplifier Pentode (Acorn Type)	5	Heater	6.3
955	Amplifier, Detector, Oscillator Triode (Acorn Type)	3	Heater	6.3

MISCELLANEOUS TYPES—Continued

Type	Description	Elec- trodes	Max. Plate Dissipation Watts	Cathode Type	Cathode Volts
956	Super-Control R-F Amplifier Pentode (Acorn Type).....	5	Heater	6.3
957	Amplifier Detector, Oscillator (Acorn Type).....	3	Filament	1.25
958	A-F and R-F Amplifier, Oscillator (Acorn Type).....	3	Filament	1.25
959	Detector Amplifier Pentode (Acorn Type).....	5	Filament	1.25
991	Voltage Regulator (Glow Discharge).....	2
1602	Amplifier Triode (Low-Microphonic Type).....	3	15	Filament	7.5
1603	Triple-Grid Detector Amplifier (Low-Microphonic Design).....	5	Heater	6.3
1608	R-F Power Amplifier, Oscillator, Class B Modulator.....	3	20	Filament	2.5
1609	Amplifier Pentode (Low-Microphonic Design).....	5	Filament	1.1
1610	Crystal-Oscillator Pentode.....	5	6	Filament	2.5
1612	Pentagrid Amplifier (Low-Microphonic Design).....	7	Heater	6.3
1613	R-F Power Amplifier Pentode.....	5	10	Heater	6.3
1614	Transmitting Beam Power Amplifier.....	4	21	Heater	6.3
1619	Transmitting Beam Power Amplifier.....	4	15	Filament	2.5
1620	Triple-Grid Detector Amplifier.....	5	Cathode	6.3
1621	Power Amplifier Pentode.....	5	Cathode	6.3
1622	Beam Power Amplifier.....	4	Cathode	6.3
1623	R-F Power Amplifier, Oscillator, Class B Modulator.....	3	25	Filament	6.3
1624	Transmitting Beam Power Amplifier.....	4	25	Filament	2.5
1851	Television Amplifier Pentode.....	5	Heater	6.3
2050	Hot Cathode Gas Tetrode.....	4	Heater	6.3
2051	Hot Cathode Gas Tetrode.....	4	Heater	6.3

TRANSMITTING TUBE ACCESSORIES

SOCKETS, END MOUNTINGS AND WATER JACKETS

Type	Description
UT-102-A	Socket (for 803)
UT-103	End Mountings (for 833)
UT-541-A	Socket (50-watt size)
UR-542-A	Socket (7½-watt size)
UT-1085-6	End Mountings (for 204-A, 849, 851, etc.)
UT-1285-A	Water Jacket (for 207, 848, 863, 891, 892)
UT-1289	Water Jacket (for 862-898) (Less mounting)
UT-4289	Mounting Insulator and Clamp (for UT-1285-A)

GASKETS (LEAD RUBBER)

Type	Description
PX-1178	(For 207, 848, 863, 1652, 891, 892)
PX-1181	(For 862, 898)
PX-1281	(For 858)

MISCELLANEOUS

(Stock No. 16679)	Hose Nipples (for 207, 848, 863, 1652, 891, 892)
MI-7422-A	Outside Filament Connector (for 891, 892)
MI-7432	Center Filament Connector (for 891, 892)
Stock No. 16402	Filament Transformer for Scott connection (for 891, 892) (2 required per tube)

IMPORTANT—Tubes should be tested immediately upon receipt from the warehouse. Tubes should be operated for a period of several days before being placed on the shelf as spares . . . TEST SPARE TUBES AT LEAST EVERY THREE MONTHS . . . Technical Information Available on Request.

RCA RECEIVING TYPE TUBES

TYPE	NAME	BASE	Dimensions Maximum Overall		Cathode Type ^(B)	RATING			USE	Plate Supply Volts	Grid Bias ^(A) Volts	Screen Supply Volts	Screen Current MA.	Plate Current MA.	A-C Plate Resistance Ohms	Trans-Conductance (Grid-Plate) μ Mhos	Amplification Factor	Load for Stated Power Output Ohms	Power Output Watts	TYPE
			Length	Diameter		Filament or Heater		Values to right give operating conditions and characteristics for indicated typical use												
						Volts	Amperes													
1B4-P	R-F Amplifier Pentode	Small 4-Pin	4 1/2" x 1 1/2"	2.0	0.06	180	67.5	Class A Amplifier	90 180	-3.0 -3.0	67.5 67.5	0.7 0.6	1.6 1.7	1000000 1500000	600 650	550 1000	—	—	1B4-P	
1F5-G	Power Amplifier Pentode	Medium Shell Octal 7-Pin	4 5/8" x 1 1/2"	2.0	0.12	135	135	Class A Amplifier	90 135	-3.0 -4.5	90 135	1.3 2.6	4.0 8.0	240000 200000	1400 1700	340 340	20000 16000	0.12 0.34	1F5-G	
1-v	Half-Wave Rectifier	Small 4-Pin	4 5/8" x 1 1/2"	6.3	0.3	—	—	Maximum A-C Plate Voltage, 350 Volts, RMS Maximum D-C Output Current, 50 Milliamperes	—	—	—	—	—	—	—	—	—	—	1-v	
2A3	Power Amplifier Triode	Medium 4-Pin	5 3/8" x 2 1/2"	2.5	2.5	250 300	—	Class A Amplifier Push-Pull Class AB Amplifier	250 300	-45.0 —	— 780 ohms, fixed bias -62 Volts, fixed bias	— —	80.0 80.0	800	5250	4.2	2500 5000 3000	3.5 10.0 13.0	2A3	
5U4-G	Full-Wave Rectifier	Medium Shell Octal 5-Pin	5 5/8" x 2 1/2"	5.0	3.0	—	—	Maximum A-C Voltage per Plate, 500 Volts, RMS Maximum D-C Output Current, 250 Milliamperes	—	—	—	—	—	—	—	—	—	—	5U4-G	
5Y4-G	Full-Wave Rectifier	Medium Shell Octal 8-Pin	4 5/8" x 1 1/2"	5.0	2.0	—	—	A-C Voltage per Plate (Volts RMS), 330 400 550 D-C Output Current (Maximum MA), 125 110 135	—	—	—	—	—	—	—	—	—	—	5Y4-G	
5Z3	Full-Wave Rectifier	Medium 4-Pin	5 5/8" x 2 1/2"	5.0	3.0	—	—	For other ratings, refer to Type 5U4-G.	—	—	—	—	—	—	—	—	—	—	5Z3	
5Z4	Full-Wave Rectifier	Small Wafer Octal 5-Pin	3 1/2" x 1 1/2"	5.0	2.0	—	—	Maximum A-C Voltage per Plate, 400 Volts, RMS Maximum D-C Output Current, 125 Milliamperes	—	—	—	—	—	—	—	—	—	—	5Z4	
6A6	Twin-Triode Amplifier	Medium 7-Pin	4 1/2" x 1 1/2"	6.3	0.8	300	—	For other characteristics, refer to Type 6N7.	—	—	—	—	—	—	—	—	—	—	6A6	
6B7	Duplex-Diode Pentode	Small 7-Pin	4 1/2" x 1 1/2"	6.3	0.3	250	125	Pentode Unit as R-F Amplifier Pentode Unit as A-F Amplifier	100 250 300	-3.0 -3.0 Self-bias, 3500 ohms; Screen Resistor = 1.1 meg.; Self-bias, 1600 ohms; Screen Resistor = 1.2 meg.	100 125 100	1.7 2.3	5.8 9.0	300000 650000	950 1125	285 730	—	—	6B7	
6C5	Detector* Amplifier Triode	Small Wafer Octal 6-Pin	2 5/8" x 1 1/2"	6.3	0.3	250	—	Class A Amplifier	90 300	Self-bias, 6400 ohms; Grid Resistor, ** Self-bias, 5300 ohms	—	—	—	—	—	—	—	—	6C5	
6C5-G	Detector* Amplifier Triode	Small Shell Octal 6-Pin	4 1/2" x 1 1/2"	6.3	0.3	250	—	Bias Detector	250	-17.0 (approx.)	—	—	—	—	—	—	—	—	6C5-G	
6C6	Triple-Grid Detector Amplifier	Small 6-Pin	4 1/2" x 1 1/2"	6.3	0.3	250	125	Amplifier Detector	—	—	—	—	—	—	—	—	—	—	6C6	
6D6	Triple-Grid Super-Control Amplifier	Small 6-Pin	4 1/2" x 1 1/2"	6.3	0.3	250	100	Class A Amplifier Mixer in Superheterodyne	100 250	-3.0 (min.) -10.0	100 100	2.2 2.0	8.0 8.2	250000 800000	1500 1600	375 1280	—	—	6D6	
6E5	Electron-Ray Tube	Small 6-Pin	4 5/8" x 1 1/2"	6.3	0.3	250	—	Visual Indicator	—	—	—	—	—	—	—	—	—	—	6E5	
6F7	Triode-Pentode	Small 7-Pin	4 1/2" x 1 1/2"	6.3	0.3	250	100	Triode Unit as Class A Amplifier Pentode Unit as Class A Amplifier	100 250	-3.0 (min.)	100	1.6 1.5	6.3 6.5	260000 850000	1050 1100	300 900	—	—	6F7	
6H6	Twin Diode	Small Wafer Octal 7-Pin	1 3/4" x 1 1/2"	6.3	0.3	—	—	Pentode Unit as Mixer Detector Rectifier	250	-10.0	100	0.6	2.8	—	—	—	—	—	—	6H6

RCA RECEIVING TYPE TUBES (Continued)

TYPE	NAME	BASE	Dimensions Maximum Overall		Cathode Type ⁽¹⁾	RATING			USE	Plate Supply Volts	Grid Bias ⁽²⁾ Volts	Screen Supply Volts	Screen Current MA.	Plate Current MA.	A-C Plate Resistance Ohms	Trans-Conductance (Grid-Plate) μ Mhos	Amplification Factor	Load for Stated Power Output Ohms	Power Output Watts	TYPE				
			Length	Diameter		Filament or Heater	Plate	Screen																
			Volts	Amperes	Max. Volts	Max. Volts	Volts	MA.	Volts	Ohms	MA.	MA.	Ohms	μ Mhos										
6J5	Detector Amplifier Triode	Small Wafer Octal 6-Pin	6.3	0.3	250	250	—	Class A Amplifier	250	-3.0	100	—	9.0	7700	2600	20	—	—	6J5					
6J5-G	Detector Amplifier Triode	Small Shell Octal 6-Pin	6.3	0.3	250	250	—	Amplifier	For other characteristics, refer to Type 6J5.											6J5-G				
6J7	Triple-Grid Detector Amplifier	Small Wafer Octal 7-Pin	6.3	0.3	250	125	125	Class A	100	0.5	2.0	1000000	1185	1500+	—	—	—	—	—					
								R-F Amplifier	250	0.5	2.0	1.5+	1225	1500+	—	—	—	—	—					
								A-F Amplifier	300 ³	Screen Resistor = 2600 ohms. Screen Resistor = 1.2 meg. Grid Resistor. ** (Gain per stage = 85 Self-bias, 1200 ohms. Screen Resistor = 1.2 meg. 0.3 megohm. Plate Resistor, 500000 ohms. Cathode current 0.43 ma.)	—	—	—	—	—	—	—	—	—					
6J7-G	Triple-Grid Detector Amplifier	Small Shell Octal 7-Pin	6.3	0.3	250	250	125	Amplifier Detector	For other characteristics, refer to Type 6J7.											6J7-G				
6K7	Triple-Grid Super-Control Amplifier	Small Wafer Octal 7-Pin	6.3	0.3	250	125	125	Class A	90	1.3	5.4	315000	1275	400	—	—	—	—	—					
								R-F Amplifier Mixer in Superheterodyne	250	2.6	10.5	600000	1650	990	—	—	—	—	—	—	—	—	—	
6K7-G	Triple-Grid Super-Control Amplifier	Small Shell Octal 7-Pin	6.3	0.3	250	250	125	Amplifier Mixer	For other characteristics, refer to Type 6K7.											6K7-G				
6K8	Triode-Hexode Converter	Small Wafer Octal 8-Pin	6.3	0.3	125	250	100	Triode Unit as Oscillator	100	3.8	—	—	—	—	—	—	—	—	—					
								Hexode Unit as Mixer	250	6.2	2.3	400000	—	—	—	—	—	—	—	—	—	—	—	
6L6-G	Beam Power Amplifier	Medium Shell Octal 7-Pin	6.3	0.9	375	250	300	Single-Tube Class A ₁ Amplifier	250	5.0	72.0	—	—	—	—	—	—	—	—					
								Push-Pull Class A ₁ Amplifier	250	10.0	120.0	—	—	—	—	—	—	—	—	—	—	—		
								Push-Pull Class A ₂ Amplifier	400	20.0	240.0	—	—	—	—	—	—	—	—	—	—	—	—	
								Push-Pull Class AB ₁ Amplifier	400	30.0	360.0	—	—	—	—	—	—	—	—	—	—	—	—	—
								Push-Pull Class AB ₂ Amplifier	400	40.0	480.0	—	—	—	—	—	—	—	—	—	—	—	—	—
6L7	Pentagrid Mixer Amplifier	Small Wafer Octal 7-Pin	6.3	0.3	250	150	150	Mixer in Superheterodyne	250	-3.0	100	7.1	2.4	—	—	—	—	—	6L7					
6N7	Twin-Triode Amplifier	Small Wafer Octal 8-Pin	6.3	0.8	300	—	—	Class A Amplifier	250	6.5	5.3	800000	1100	880	—	—	—	—	—					
								(As Driver) ⁽³⁾ Class B Amplifier	294	5.0	7.0	113000	3100	35	20000	exceeds 0.4	—	—	—	—	—	—		
6N7-G	Twin Triode Amplifier	Medium Shell Octal 8-Pin	6.3	0.8	300	300	—	Amplifier	For other characteristics, refer to Type 6N7.											6N7-G				
6R7	Duplex-Diode Triode	Small Wafer Octal 7-Pin	6.3	0.3	250	—	—	Triode Unit as Class A Amplifier	90 ⁴	Self-bias, 4400 ohms; Grid Resistor. ** (Gain per stage = 10 Self-bias, 3800 ohms.)	—	—	—	—	—	—	—	—	—					
								Class A Amplifier	300 ⁴	—	—	—	—	—	—	—	—	—	—	—	—	—	—	
6Y6-G	Beam Power Amplifier	Medium Shell Octal 7-Pin	6.3	1.25	200	135	135	Single-Tube Class A ₁ Amplifier	135	135	3.0	43.0	—	—	—	—	—	—	—					
								Voltage Doubler Half-Wave Rectifier	200	135	2.2	60.0	—	—	—	—	—	—	—	—	—	—	—	
25Z5	Rectifier-Doubler	Small 6-Pin	25.0	0.3	—	—	—	Maximum A-C Voltage per Plate. Maximum D-C Output Current. 125 Volts, RMS	—	—	—	—	—	—	—	—	—	—	—					
								Maximum A-C Voltage per Plate. Maximum D-C Output Current. 100 Milliamperes	—	—	—	—	—	—	—	—	—	—	—	—	—	—	—	

RCA RECEIVING TYPE TUBES (Continued)

TYPE	NAME	BASE	Dimensions Maximum Overall	Cathode Type	RATING			USE	Plate Supply Volts	Grid Bias Volts	Screen Supply Volts	Screen Current MA.	Plate Current MA.	A-C Plate Resistance Ohms	Trans- Conduc- tance (Grid- Plate) μMhos	Amplifi- cation Factor	Load for Rated Power Output Ohms	Power Out- put Watts	TYPE
					Filament or Heater	Plate Max. Volts	Screen Max. Volts												
30	Detector- Amplifier Triode	Small 4-Pin	4 3/8" x 1 1/8" Diameter	D-C Filament	2.0	0.06	180	90 135 180	4.5 9.0 -13.5	—	—	2.5 3.0 3.1	11000 10300 10300	850 900 900	9.3 9.3 9.3	—	—	30	
41	Power Amplifier Pentode	Small 6-Pin	4 3/8" x 1 1/8"	Heater	6.3	0.4	250	100 250	7.0 -18.0	100 250	1.6 5.5	9.0 32.0	103300 68000	1450 2200	150 150	12000 7600	0.33 3.40	41	
45	Power Amplifier Triode	Medium 4-Pin	4 1/8" x 1 1/8"	Filament	2.5	1.5	275	180 275 275	-31.5 -56.0 Self-bias, 775 ohms	—	—	31.0 36.0	1650 1700	2125 2050	3.5 3.5	2700 4600	0.82 2.00	45	
57	Triple-Grid Detector Amplifier	Small 6-Pin	4 1/8" x 1 1/8"	Heater	2.5	1.0	250	275	-68.0 volts, fixed bias	—	—	36.0	—	—	—	5060 3200	12.0† 18.0†	57	
For other characteristics, refer to Type 617.																			
76	Super-Triode Amplifier Detector	Small 5-Pin	4 3/8" x 1 1/8"	Heater	6.3	0.3	250	100 250 300	5.0 -13.5 Self-bias, 6500 ohms; Self-bias, 6400 ohms; { approx. }	—	—	2.5 5.0	12000 9500	1150 1450	13.8 13.8	—	—	—	76
Plate current to be adjusted to 0.2 milliamperes with no signal.																			
80	Full-Wave Rectifier	Medium 4-Pin	4 1/8" x 1 1/8"	Filament	5.0	2.0	—	250	—	—	—	—	—	—	—	—	—	—	80
84/6Z4	Full-Wave Rectifier	Small 5-Pin	4 3/8" x 1 1/8"	Heater	6.3	0.5	—	—	—	—	—	—	—	—	—	—	—	—	84/6Z4
85	Duplex-Diode Triode	Small 6-Pin	4 1/2" x 1 1/8"	Heater	6.3	0.3	250	135 250	-10.5 -30.0	—	—	3.7 8.0	11000 7500	750 1100	8.3 8.3	25000 20000	0.075 0.350	85	
89	Triple-Grid Power Amplifier	Small 6-Pin	4 1/2" x 1 1/8"	Heater	6.3	0.4	250	100 250	-30.0 -31.0	—	—	17.0 32.0	3300 2600	1425 1800	4.7 4.7	7000 5500	0.30 0.90	89	
112-A	Detector- Amplifier Triode	Medium 4-Pin Bayonet	4 1/8" x 1 1/8"	D-C Filament	5.0	0.25	180	100 250	10.0 -25.0	100 250	1.6 5.5	9.5 32.0	104000 70000	1200 1800	125 125	10700 6750	0.33 3.40	112-A	
874	Voltage Regulator	Medium 4-Pin Bayonet	5 3/8" x 2 3/8"	—	—	—	—	180	0	—	—	6.0	—	—	—	13600 9400	2.50† 3.50†	874	

† For Grid-leak Detection—plate volts 45, grid return to + filament or to cathode.
 ‡ Either A. C. or D. C. may be used on filament or heater, except as specifically noted. For use
 D.C. on A-C filament types, decrease stated grid volts by 1/2 (approx.) of filament voltage.
 ■ Grid #1 is control grid. Grid #2 is screen. Grid #3 tied to cathode.
 † Grid #1 is control grid. Grids #2 and #3 tied to plate.
 ‡ Grids #1 and #2 connected together. Grid #3 tied to plate.
 † Triode Plate-Supply Voltage and Max. Target Voltage = 100 volts.
 ‡ Both grids connected together; likewise, both plates.
 † Power output is for two tubes at stated plate-to-plate load.
 ‡ For two tubes.
 ‡ Grids #2 and #4 are screen. Grid #1 is signal-input control grid.

‡ For signal-input control-grid (#1); control-grid #3 bias = 3 volts.
 ‡ Applied through plate resistor of 100000 ohms.
 ‡ Applied through plate resistor of 250000 ohms.
 ‡ Requires different socket from small 7-pin.
 ‡ Grid #2 tied to plate.
 ‡ For grid of following tube.
 ‡ Plate voltages greater than 125 volts RMS require 100-ohm (minimum) series-plate resistor.
 ‡ Note 1: Types with actual bases have Miniature Metal Cap; all others have Small Metal Cap.
 ‡ Note 2: Subscript 1 on class of amplifier service (as AB₁) indicates that grid current does not flow
 during any part of input cycle.
 ‡ Subscript 2 on class of amplifier service (as AB₂) indicates that grid current flows during
 some part of the input cycle.

Minimum D-C Starting Supply Voltage.....125 Volts
 D-C Operating Voltage.....90 Volts

Maximum A-C Voltage per Plate.....350 Volts, RMS
 Maximum D-C Output Current.....90 Milliamperes

OTHER RCA PRODUCTS

RCA products include a wide variety of apparatus used in nearly all forms of radio service and in kindred fields. While it is not possible to provide complete listings of all of the equipment for other applications, outlines of the various types of equipment have been given together with information as to where further data may be obtained.

The slogan "RCA ALL THE WAY" means more than merely a complete line of equipment in the broadcast transmitting and receiver field. It means a complete service for radio in all of its branches. These comprehensive facilities are exclusive with RCA. The resulting wide experience of RCA engineers in every radio application and the complete lines of equipment offered make it advantageous to go to RCA for radio apparatus of any sort.

RCA AVIATION RADIO EQUIPMENT

RCA aviation radio equipment includes transmitters and receivers for either aircraft or ground station use, radio compass equipment and accessory apparatus. RCA equipment is used extensively by itinerant fliers and by airlines. This apparatus uses latest developments and is designed specifically for the rigid requirements of aviation service.

The AVR-8 D and E Radio Compass equipments provide both visual and aural direction indication and cover the bands of 200-410, 550-1500 and 2200 to 6700 KC. (Bands 200-410; 550-1500 can only be used for radio compass). Thus pilots may use the instrument for navigating conventional radio range courses, for broadcast reception, for weather and reception on aviation frequencies. Broadcast and radio range stations may be used for directional bearings. The receiver operates from a 12 volt supply and is equipped either with a fixed or rotatable streamlined loop housing.

Aircraft receivers include the AVR-7 D, E, F and G series covering 195 to 420, 490-1400 and 2300-6700 KC. These receivers may be obtained with crystal control if desired. The AVR-10 is a standard receiver designed for Class I aircraft for weather or airport traffic control information or as an auxiliary receiver for other classes of aircraft. This covers the band of 200-400 KC. and weighs only 8.5 lb. complete.

The Model AVT-7 B is a 2 channel, 2 frequency, telephone transmitter designed specifically for itinerant fliers. Frequencies of 3105; 3120; 6210 and 6240 KC. can be obtained with only two crystals. The AVT-12 B will supply 50 watts phone or 90 watts CW on 2 channels, 4 frequencies. It is useful for airlines or for itinerant fliers.

Ground station equipment, antennas and crystal control units for receivers are also available. RCA Aviation Radio equipment is distributed nationally by Air Associates, Inc. A hangar at the Camden Airport is equipped with a complete line of RCA aviation radio apparatus and pilots may inspect any of the units here. Installation and service facilities are available to the plane owners by more than a score of RCA Aviation Distributors throughout the United States.

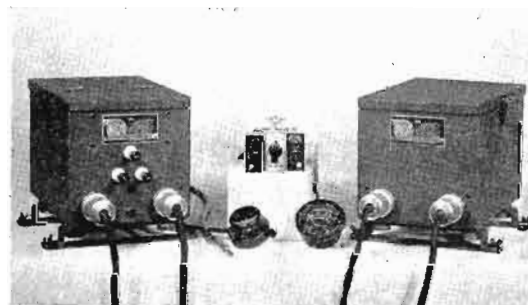

Left—View of AVT-7B Complete Transmitter Assembly.

Below—View of Receiver Case and Control Panel of AVR-7G Aviation Receiver.

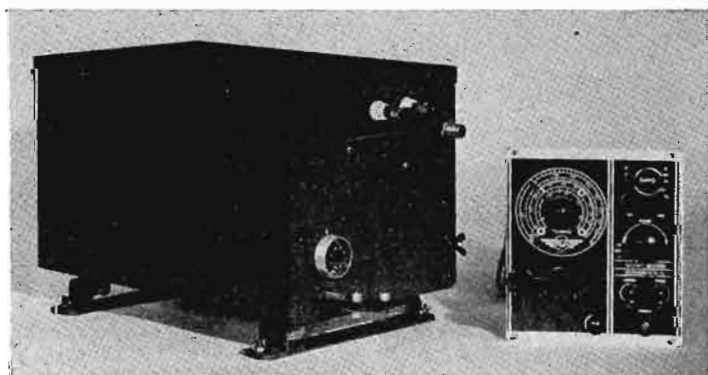

Right—Picture of AVR-8E Aviation Radio Compass Assembly.

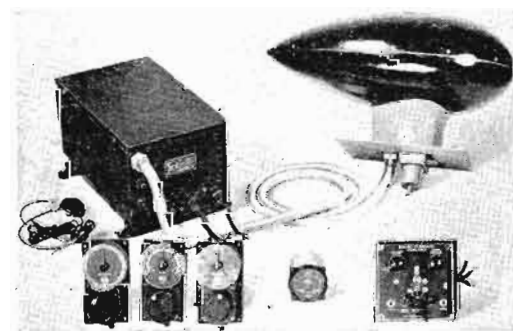

RCA POLICE RADIO SYSTEMS

RCA Police Radio Equipment furnishes a network of rapid communications to help preserve law and order. RCA equipment is used by more than 125 municipalities throughout the United States, including such outstanding installations as Cleveland and St. Paul, as well as in some seven states where radio is employed. The State of Michigan, for example, one of the pioneers in using radio as a police aid, is equipped with two RCA 5 KW. transmitters and one 1 KW. transmitter. Many of the smaller communities have depended on RCA's low power, ultra high frequency apparatus for years for communication with prowl cars. RCA equipment is also utilized by the Federal police agencies and RCA gun detector equipment is installed in a number of prisons to prevent smuggling of weapons.

The police radio line consists of conventional frequency apparatus operating in the band of 1610 to 2508 kilocycles and "Terrawave" ultra high frequency equipment. Conventional frequency transmitters can be supplied in the power range of 50 to 5000 watts. Receivers are also available for station house use, for car installations and for motorcycles. RCA conventional police band receivers feature rugged construction designed for hard service, thermally compensated tuning condensers to prevent detuning, long life dynamotors and great sensitivity.

Below—View of Police Radio Receiver MI-7802

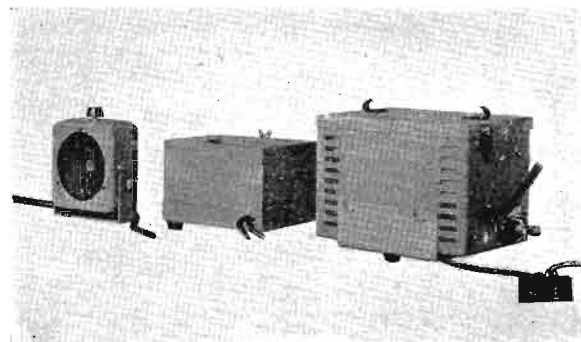

Terrawave equipment includes central station ultra high frequency transmitters from 15 watts up to 1000 watts, car talkback transmitters and both mobile and fixed receivers. The receiver line is designed to minimize ignition noise and to reduce the receiver output except during transmission. Transmitters include precision crystal control, high quality transmission and excellent electrical and mechanical design.

RCA Police Radio Equipment is sold through any of the RCA representatives and installations are handled through the extensive nationwide service organization. RCA motorcycle receivers are designed specially for and sold through the Harley Davidson and Indian Motorcycle firms.

This line of police radio equipment is steadily growing in popularity and every year finds more and more communities turning to RCA for apparatus to aid their police departments in rendering more efficient and effective service.

Right—Picture of RCA Station House Receiver AR-5025.

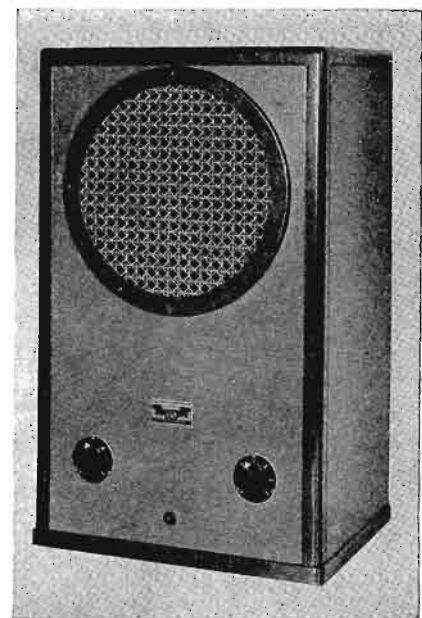

COMMERCIAL SOUND EQUIPMENT

INCLUDED in the Commercial Sound line is a full series of public address equipment, both portable and for fixed use, audio distribution systems for hotels or schools, radio distribution systems for utilizing a common antenna in apartment houses, inter-office communication units and accessories. This apparatus has been designed by RCA engineers specifically for each purpose and the equipment is reasonably priced yet high in quality.

Among the popular, low priced portable public address systems is the PG-111, weighing only 25 lb. complete with loudspeaker and amplifier in a single carrying case. Rated at 6 watts output, it is convenient to carry and easy to set up. The PG-114 provides a greater output, 24 watts, and weighs but 60 lb. This unit is equipped with two speakers, the whole unit fitting into two carrying cases. Remote mixing for controlling stage microphones is provided. The intermediate PG-112 has an output of 12 watts and may be operated either from a 110 volt A.C. supply or from a 6 volt storage battery in conjunction with a dynamotor.

Fixed type public address equipment may be obtained complete or in major component form. Systems from 6 watts to 200 watts output are stocked with appropriate speakers for indoor or outdoor use.

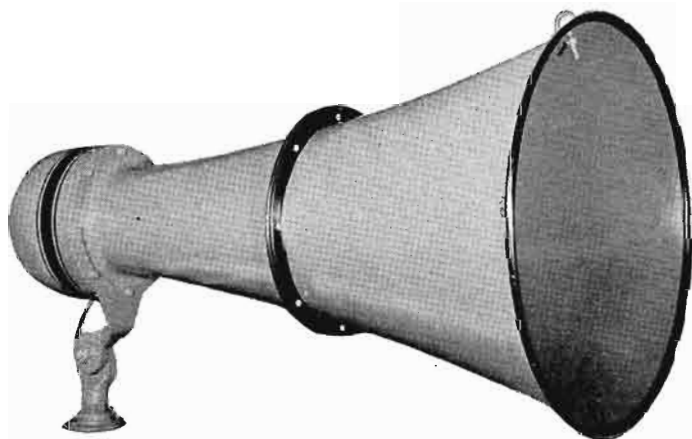

*MI-6256 RCA Super Sound Projector
for long distance projection of quality sound.*

*RCA
Portable
Sound
System
PG-114*

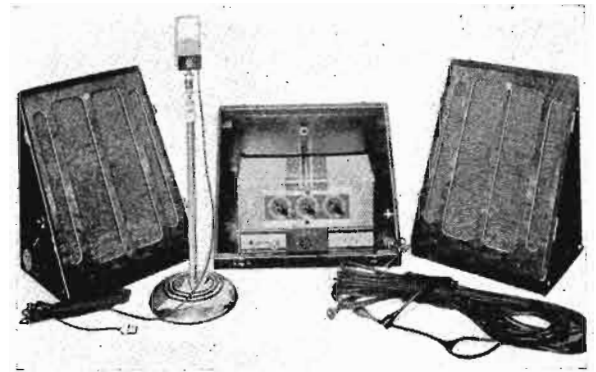

For example, the MI-6256 sound projector will handle 100 watts with excellent fidelity.

The RCA Multi-Wave Antenaplex System permits a common antenna to be used in a building with any number of outlets for receivers. It covers the range



*RCA Victor
inter-communicating system
that requires
no wires,
MI-6350.*

of 530 to 18,000 KC. The RCA School Sound System provides audio distribution to classrooms for radio, records or voice announcements.

Inter-office communication units, (such as a pair of MI-6350 units) either for wire connection or for carrier over the power line are available. Broadcasting stations will find these useful for talking between transmitter and antenna tuning house or between offices. It is only necessary to plug two RCA Victor-Phones into the light sockets and communication is instantaneous.

Commercial Sound apparatus is sold through distributors in larger cities. A separate catalog of these products is available.

PHOTOPHONE EQUIPMENT

RCA's "Magic Voice of the Screen" Photophone equipment is installed in more than 5,000 theatres in the U. S. A. and in numerous theatres throughout the world.

RCA Photophone recording equipment is used by film producers such as RKO, Columbia Pictures, Twentieth Century Fox, Warner Brothers, Pathe, Walt Disney, March of Time, and many others.

Photophone reproducing equipment is available for small theatre or for private exhibition rooms as well as for the largest auditoriums. Installations at the Radio City Music Hall in New York, and Grauman's Chinese Theatre in Hollywood, typify the larger class. Portable projector equipment and sound systems can also be obtained for private use or for commercial exhibitions.

For high fidelity reproduction of sound on film, RCA Photophone leads the way to "Sound Satisfaction."

Absolute proof of RCA's leadership in the recording and reproducing of sound on film was acclaimed to the world when the Academy of Motion Picture Arts and Sciences paid tribute to the world's finest sound by awarding RCA Photophone three of their coveted awards.

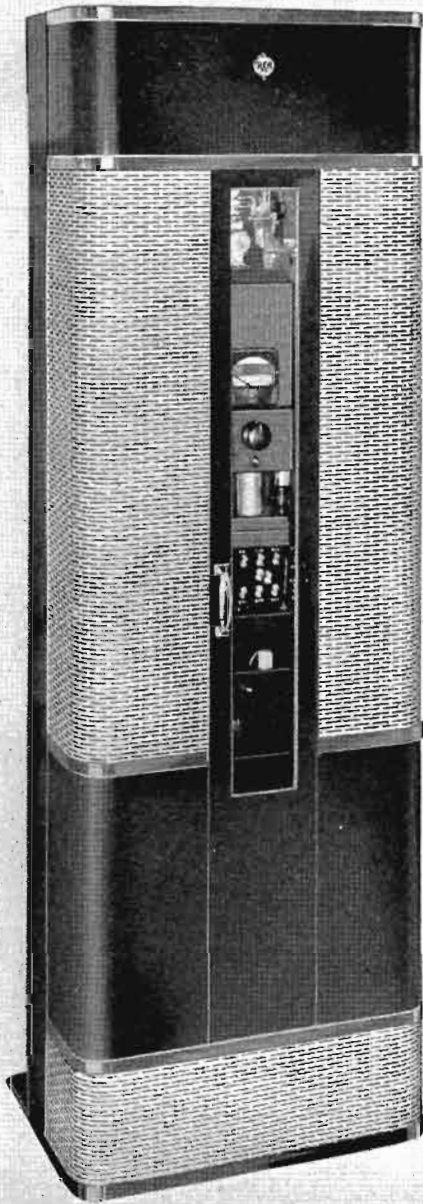

MI-9210 Amplifier

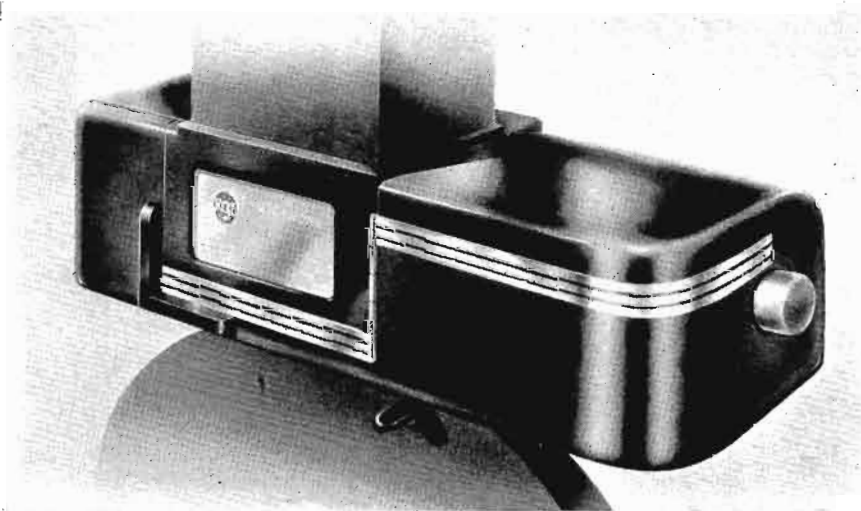

MI-9050 Rotary Stabilizer Soundhead with Shockproof Drive

COMMUNICATIONS EQUIPMENT

RCA equipment for communications purposes is used by amateurs for friendly exchanges of messages, by those needing special transmission apparatus such as expeditions, foreign governments and for use where stringent broadcast performance is not required. The line of apparatus includes transmitters and receivers, among which are the following:

AR-60 COMMUNICATION RECEIVER

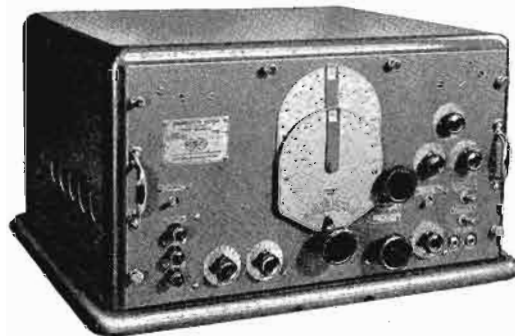

The AR-60 Communication Receiver was designed primarily for commercial communication service, consequently every electrical and mechanical detail in its construction and test has been given thorough attention to meet every exacting requirement. The AR-60 employs an eleven-tube superheterodyne circuit with crystal filter. Six ranges of tuning are provided to give continuous tuning from 1500 to 25,000 KC. Electrical band spread is employed with separate dials for band set and calibration spread. The three low frequency ranges employ one tuned r-f stage and the three high frequency ranges have two tuned r-f stages, to provide minimum image-frequency response. Maximum signal-to-noise ratio has been obtained. The h-f oscillator is supplied with regulated anode voltage to assure steady c-w telegraph reception with severe changes in line voltage and during "Break-in" operation.

The i-f amplifier employs three stages of amplification. AVC can be used for both C.W. and 'phone reception. The audio output may be peaked at 800 cycles which greatly reduces background noise, etc. Headphone operation is normally used. However, good room volume may be obtained with the use of a sensitive permanent magnet dynamic loudspeaker. The integral power supply may be used with either 110 or 220 volts, 40-60 cycle power source. Provision has been made to use batteries if desired.

Connections can be made to provide "break-in" or "stand-by" operation. The AR-60 is available in three cabinet styles: (1) Standard rack mounting with dust cover and black wrinkle finish. (2) Table mounting with square edge cabinet having black wrinkle finish. (3) Deluxe table mounting with round edge cabinet having two-tone gray finish (illustrated).

ACT-20 TRANSMITTER



The ACT-20 Transmitter employs a three stage r-f circuit of unique design that simplifies adjustment when changing coils and crystals. The ACT-20 has a power output rating of 16 watts for 'phone and 20 watts C.W. throughout the operating range of 1715 to 30,000 KC. The r-f tube complement is as follows: RCA 807 crystal-controlled oscillator, RCA 802 buffer/doubler, RCA 807 power amplifier operating "Class C." The audio complement comprises an RCA 6F5 speech amplifier, RCA 6F6

driver, and two RCA 6L6 modulators operating "Class B." The microphone input circuit is arranged for a double-button carbon microphone such as RCA Model MI-6225-A. The power supply is an integral part of the transmitter and employs two RCA-82 tubes for all rectified voltage requirements including the microphone. The entire transmitter is housed in a two-tone gray cabinet suitable for table mounting.

ACT-150 TRANSMITTER



The ACT-150 Transmitter employs high level modulation and is conservatively rated at 150 watts output, both c.w. and 'phone throughout its operating range from 1.7 to 30.0 megacycles. Band change is accomplished by plug-in crystals and coils. The r-f tube lineup is as follows: RCA 807 Crystal Oscillator, RCA 802 Buffer/Doubler, two RCA 807 Drivers, and two RCA-808 Power Amplifiers operating Class C. The audio tubes are as follows: RCA 6J7 Speech Input, two RCA 6C5 Voltage Amplifiers in cascade, two RCA 2A5 Drivers and two RCA 808 Modulators operating Class B. The RCA 6J7 and two RCA 6C5 tubes are in the speech Amplifier Unit with gain control, which is housed in a separate cabinet that may be placed on the operating desk.

A separate high voltage power supply employs two RCA 866 tubes as full wave rectifiers. The plate supply for the exciter stages is obtained through an RCA 83. An RCA 5Z3 furnishes the bias voltage for all requirements and plate voltage for the audio driver tubes. An RCA 80 integral with the speech amplifier unit furnishes plate voltage for this circuit. The Transmitter and Speech Amplifier cabinets are finished with two-tone gray crackle finish and handsome escutcheon plates labeling all of the front-panel controls.

AR-67 COMMUNICATIONS RECEIVER

The AR-67 is a long wave receiver designed for commercial service and covering the band of from 75-1500 KC continuously. It is A.C. or battery operated and is arranged for C.W. or phone reception.

The superheterodyne circuit is employed with one r.f. stage, two i.f. stages with litz wound magnetite core transformers and two audio stages with push-pull output. The receiver is provided with a manual and automatic sensitivity control and C.W. heterodyne oscillator. Two degrees of selectivity may be obtained by means of auxiliary windings on the i.f. transformers for speech or telegraph reception. An output limiter is provided, variable and coupled to the volume control.

Nine tubes are employed although the use of dual purpose tubes provides the equivalent of 13. The receiver may be operated from external batteries (headphone reception) using a 6 volt A battery and a 90 volt B battery or from an A.C. supply of 40-60 cycles, 110, 125, 150, 210 or 240 volts. Either cabinet or rack mounting may be sup-

plied. The output is for a 600 ohm line, headphones or loudspeaker. Sensitivity is better than 5 microvolts for 50 milliwatts output.

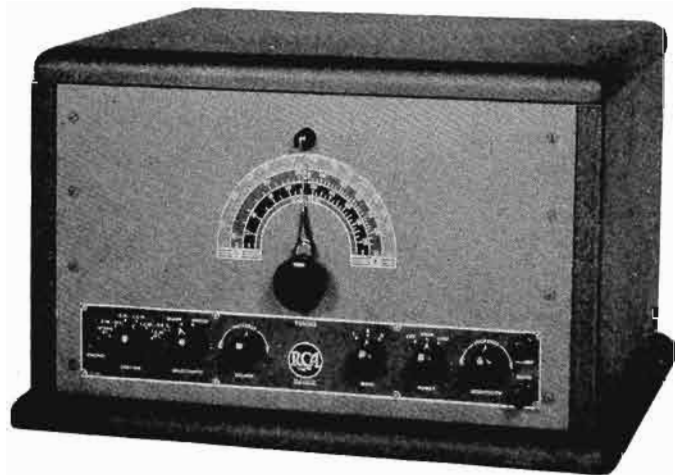

Particular precautions have been taken to prevent damage from moisture or severe climatic conditions. In fact, in every respect, the AR-67 is a sturdy, reliable and sensitive communications receiver.

AR-4291 TRANSCEIVER

This transceiver unit has been designed chiefly for communications purposes and is a sturdy yet portable unit weighing only fifteen pounds. It will operate in the range of 30-65 megacycles with an output of approximately 0.7 watts. The transceiver employs two tubes, an RCA-30 and an RCA-1F5G. With these tubes and with the standard batteries, a life of thirty hours continuous use will be obtained with one set of batteries.

The unit itself is approximately $5\frac{7}{8}$ " x $9\frac{1}{4}$ " x $13\frac{1}{2}$ ". It contains a telescoping antenna which can be pulled out when the lid is opened. The range is covered by the use of two plug-in coils and mounting space is provided for the coil not in use. A filament voltmeter is mounted on the panel.

The unit is designed to operate on the same frequency for transmission and reception with compensation to assure that the same frequency will be employed for both modes of operation. Calibration curves are mounted inside of the lid to aid in tuning. The batteries employed consist of three Z-30PX 45 volt B batteries, two 4FH A batteries and one 5540 C battery (Burgess).

The unit is finished in gray wrinkle and is provided with a carrying strap for convenient use.

All parts are adequately protected when the unit is closed.

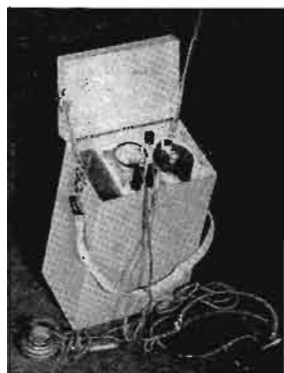



RCA

ALL THE WAY
From the Microphone
in the Studio to the
Receiver in Your
Home





BROADCAST STATION EQUIPMENT PRICE LIST

Apparatus prices have been arranged in the order of listing in the catalog and are indexed to the catalog pages. In order to find any item by type number, please refer to the catalog index and then consult this list in accordance with the page number.

Prices listed herein are net to broadcasting stations on purchases made directly from the RCA Manufacturing Company, Inc., or through its own field offices. Prices are quoted f.o.b. point of manufacture (Camden, N. J., for transmitting equipment and microphones; Indianapolis, Ind., for most speech input equipment; Harrison, N. J., for transmitting or special purpose tubes, unless a nearer district warehouse is specified). Prices are subject to change after 30 days from the above date and the manufacturer reserves the right to modify apparatus from the printed specification. Equipment will be shipped by the carrier requested whenever feasible although vacuum tubes will be shipped by express only, except under special circumstances. Prices on other equipment not listed herein may be obtained from field representatives.

NOTES: Master Item numbers used to identify apparatus on invoices and packing slips are given for each unit.

CATALOG ERRATA

- Page 13—Aerodynamic Microphone Change to MI-6226D. 30 foot cable.
- Page 28—Type 76-B1 Consolette Supersedes 76-B.
- Page 49—57-B supersedes 57-A Switch and fuse panel.
- Page 50—Type 9-A, 9-B, 9-C and 9D racks no longer carried in stock.
- Page 53—Field Supply change to 79A.
- Page 53—64-B supersedes 64-AX Loudspeaker.
- Page 56—Omit MI-4857 Lateral tone arm kit.
- Page 90—Change reference 305-A Oscillograph from page 15 to 101.
- Page 94—Change reference No. 9796 Transformer from page 19 to 105.
- Page 94—MI-1520 Filament Supply Unit no longer carried in stock.

ADDITIONS

- Page 15—MI-4089 Cable hook for 90-A stand.
- Page 26—Type 80-AX Two Studio Control Desk with VU Meter.
- Page 27—Type 80-BX Single Studio Control Desk with VU Meter.
- Page 28—MI-11702 "On Air" Light Relay for 76-B1, 80-A and 78-B1.
- Page 28—MI-11703 Extra Speaker Relay for 76-B1.
- Page 43—Type 83-C Line Amplifier.
- Page 58—Type OP-5X Remote Amplifier with vu Meter.
- Page 59—Type OP-6 Remote Amplifier.
- Page 99—Type 300-A Three Element Array Kit.
- Page 106—Type 311-A Broadcast Frequency Monitor.
- Page 106—Type 312-A RF Noise Meter.
- Page 29—Type MI-63 Interconnecting Cable, Twisted Pair Shielded (Solid Conductor).
- Page 29—Type MI-64 Interconnecting Cable, Twisted Pair Shielded (Stranded Conductor).

Type Number	Master Item No.	MICROPHONES	Net Price	Catalog Page
44-BX	4027-B	Standard Velocity Microphone*	\$65.00	8
74-B	4036-C	Junior Velocity Microphone*	19.00	9
77-B1	4043	Uni-directional Velocity Microphone*	50.00	10
77-C1	4044	All Purpose Microphone (250 ohms)*	60.00	11
77-C	4042-B	All Purpose Microphone (50 ohms)*	60.00	11
88-A	4048-A	Pressure Microphone*	27.75	12
	4015	High Level Talk-Back Microphone with "press to talk" stand	28.00	13
	6226D/6227	Aerodynamic Microphone, 30 foot cable and stand	11.80	13
30-A	4001-B	Lapel Microphone, 25' ft. cable, Hubbell plug	14.50	14
PB-112-B1	2052-B/2062	Sound Power Handset, each, 6 ft. cable	33.75	14
	MI-62	Microphone cable (44-BX)	11c per ft.	14
	MI-59	Microphone cable (74-B, 77-B, 77-C and 88-A)	8c per ft.	14

* Including 30' shielded rubber cable, less plug.

CANNON PLUG AND RECEPTACLES

P3-CG-12S	4630	Male plug to fit P3-35 Receptacle	2.35	14
P3-35	4624-A	Wall Receptacle (no cover)	5.50	14
P3-CG-11S	4620	Female Connector for P3-CG-12S	4.00	14

STANDS

90-A	4090	DeLuxe Program Stand	22.50	15
90-C	4094	DeLuxe Boom Stand	54.00	15
91-A	4058-A	Desk Stand	5.50	15
AP-4234	4060-B	Adaptor for 91-A	3.00	15
	4068-A	Light Program Stand	6.90	15
	4065-B	Banquet Stand	3.75	15
59-A	4059-A	Collapsible, portable stand	20.00	15
91-B	4092	Desk Stand	5.50	15
	4089	Cable hook for 90-A	3.50	

SPEECH INPUT EQUIPMENT

Factory Assembled Equipment

78-B-1	{ 4296-C 4647-C 4308-A	Two Studio Speech Input Equipment Rack and Control Console and Relay Rectifier — less tubes (Black Finish)	1,700.00	24
		One set of tubes for 78-B-1	65.04	24
		Same, finished in Umber Gray and Same, finished in Umber Gray and Same, finished in Umber Gray	1,700.00	24
78-B-1	{ 4296-D 4647-D 4308-C	Single Studio Speech Input Equipment Rack and Control Console and Relay Rectifier — less tubes (Black Finish)	1,625.00	25
		One set of tubes for 78-C-1	65.04	25
		Same, finished in Umber Gray and Same, finished in Umber Gray and Same, finished in Umber Gray	1,625.00	25
78-C-1	{ 4296-E 4647-E 4308-A	Two Studio Control Desk (Black Finish). <i>Uses vu Meter.</i> Including Relay Rectifier. Less tubes	1,525.00	26
80-AX	{ 11605-D 4308-A	One set of tubes for 80-AX	48.86	26
80-AX	{ 11605-E 4308-C	Two Studio Control Desk (Umber Gray Finish). <i>Uses vu Meter.</i> Including Relay Rectifier. Less tubes	1,525.00	26
80-B	{ 11604 4308-A	Single Studio Control Desk (Black Finish). Including Relay Rectifier. Less tubes	1,050.00	27
80-BX	{ 11604-B 4308-A	One set of tubes for 80-B	43.71	27
80-BX	{ 11604-C 4308-C	Single Studio Control Desk (Black Finish). <i>Uses vu Meter.</i> Including Relay Rectifier. Less tubes	1,100.00	27
80-BX	{ 11604-C 4308-C	Single Studio Control Desk (Umber Gray Finish). <i>Uses vu Meter.</i> Including MI-4308-C Relay Rectifier. Less tubes	1,425.00	27
76-B-1	{ 11613 11301-A	Two Studio Console Speech Input Equipment, less tubes, inc. Power Supply for 76-B-1 less tubes (Umber Gray)	825.00	28
		One set of tubes for 76-B-1	39.25	28
	11702	Light Relay for 76-B-1, 80-A, 80-B, 78-B1 and 78-C1	8.00	

Type Number	Master Item No.	SPEECH INPUT EQUIPMENT (continued)	Net Price	Catalog Page
	11703	Speaker relay for 76-B-1.....	8.00	
81-A	4647-A	Control Console (78-B Type) (Black).....	325.00	29
81-B	4647-B	Control Console (78-C Type) (Black).....	300.00	29
	MI-63	Interconnecting Cable twisted pair shielded (solid conductor)	23.00 per 1000 ft.	
	MI-64	Interconnecting Cable twisted pair shielded stranded conductor	33.00 per 1000 ft.	
	11500	Wall Mounting Jack and Equalizer Cabinet (Umber Gray) ..	40.00	29
SPEECH INPUT UNITS				
41-C	4206	†Three-Channel Pre-Amplifier, less tubes (Black).....	200.00	32
		One set of tubes for 41-C.....	28.50	32
40-D	4295-A	†Program Amplifier, less tubes (Black).....	250.00	33
		One set of tubes for 40-D.....	13.79	33
55-B	4214	†Bridging Amplifier, less tubes (Black).....	225.00	34
		One set of tubes for 55-B.....	6.65	34
94-D	4270	†Monitoring Amplifier, less tubes (Black).....	135.00	35
		One set of tubes for 94-D.....	22.75	35
96-AX	{11201-A	†Limiting Amplifier, including one set of tubes } & VU meter	475.00	36
	{11300	°Power Supply Unit, including one set of tubes } (Black)		
	11250	Matched pair 6K7 tubes for 96-A.....	2.70	36
		One set of tubes for 96-A, less matched 6K7's.....	8.13	36
15-C	4398	†Illuminated Meter Panel (Black).....	60.00	37
46-B	4152	†Mixer and Switching Panel (Black).....	130.00	37
15-B	4390-A	†Meter Panel (Black).....	40.00	39
15-D	4388	°Meter Panel.....	35.00	39
41-B	4205-E	°Pre-Amplifier, incl. filament transformer, less tubes (Black)	50.00	39
		One set of tubes for 41-B.....	9.50	39
40-C	4292-C	†Program Amplifier, less tubes (Black).....	175.00	40
		One set of tubes for 40-C.....	13.75	40
85-B	11207	Pre-Amplifier, less tubes.....	40.00	42
		One set of tubes for 85-B.....	2.50	42
85-X	11208	Single Stage Isolation Amplifier.....	50.00	43
		One set of tubes for 85-X.....	2.50	43
RT-386	11606	Filament transformer.....	6.00	44
	11302	Power Supply for preamplifier.....	60.00	44
	4303	Power Supply for preamplifier.....	23.50	44
84-B	11204	Program and Line Amplifier, less tubes.....	125.00	45
		One set of tubes for 84-B.....	10.30	45
82-B	11205	Monitoring Amplifier, less tubes.....	85.00	46
		One set of tubes for 82-B.....	13.75	46
	4313-A	Compensating Network for 82-B.....	4.00	46
	11203	Filter Kit for 82-B (for preamplifier supply).....	15.00	46
83-C	11206-B	Line and Isolation Amplifier, less tubes.....	100.00	46
		One set of tubes for 83-C.....	6.65	46
36-A	4681-C	Panel and Shelf (Three RCA Finishes).....	28.00	47
	11701	Plate Current Switch.....	2.75	47
	11700	Plate Current Indicating Meter, Illuminated Streamlined case	35.00	47
36-B	4682	°Panel and Shelf (Three RCA Finishes).....	15.00	47
	11501	°Single Jack Mat (Black).....	7.00	49
	11502	°Double Jack Mat (Black).....	7.50	49
	11503	°Triple Jack Mat (Black).....	8.00	49
SPEECH INPUT ACCESSORIES				
57-B	4399	°Switch and Fuse Panel.....	18.00	49
33-A	4645	Jack Panel.....	42.00	49
33-B	4646	Jack Panel.....	22.00	49
	4652-2A	Patch Cord 2 ft. (Gray).....	9.00	49
	4652-4	Patch Cord 4 ft.....	9.25	49
	4652-6	Patch Cord 6 ft.....	9.50	49
9-AJX	4519/4537	* Cabinet Rack including 2 MI-4537-A "J" Strips.....	95.00	50
9-AUX	4519/4524	* Cabinet Rack including 1 MI-4524-A "U" Strip.....	90.00	50
9-AJZ	4519/4656	* Cabinet Rack including 4 brushed chrome "J" Strips and trim	118.00	50
9-AUZ	4519/4658	* Cabinet Rack including brushed chrome "U" Strips and trim.	100.00	50
* Racks and blank panels can be furnished in Black, Transmitter Gray or Umber Gray at same price. Specify color when ordering.				
° For Umber Gray or Transmitter Gray, add \$1.50. † For Umber Gray or Transmitter Gray, add \$3.00.				

Type Number	Master Item No.	SPEECH INPUT ACCESSORIES (Continued)	Net Price	Catalog Page
	4656	Brushed Chrome "J" trim for 9-AZ Rack.....	\$35.00	50
	4658	Brushed Chrome "U" trim for 9-AZ Rack.....	15.00	50
	4524-A	"U" Strips for 9-AX Rack, (Three RCA Finishes) each.....	5.00	50
	4537-A	"J" Strips for 9-AX Rack, (Three RCA Finishes) each.....	5.00	50
35-AA	4540-A	†Deluxe Shelf (Black Finish).....	20.00	50
35-B	4541	†Standard Shelf (Black Finish).....	25.00	50
35-C	4542	†Standard Shelf (Black Finish).....	30.00	50
	4590	Blank Panel (1-23/32" Width) (Three RCA Finishes).....	1.50	50
	4598	Blank Panel (2-1/8" Width) (Three RCA Finishes).....	1.50	50
	4599	Blank Panel (2-3/8" Width) (Three RCA Finishes).....	1.50	50
	4589	Blank Panel (3-3/32" Width) (Three RCA Finishes).....	1.50	50
	4591	Blank Panel (3-15/32" Width) (Three RCA Finishes).....	1.50	50
	4592	Blank Panel (5-7/32" Width) (Three RCA Finishes).....	2.00	50
	4593	Blank Panel (6-31/32" Width) (Three RCA Finishes).....	2.00	50
	4594	Blank Panel (8-23/32" Width) (Three RCA Finishes).....	2.50	50
	4595	Blank Panel (10-15/32" Width) (Three RCA Finishes).....	2.50	50
	4596	Blank Panel (12-7/32" Width) (Three RCA Finishes).....	3.25	50
56-B	4167-A	†Variable Line Equalizer (Black Finish).....	95.00	51
56-C	4168	Fixed Line Equalizer.....	15.00	51
56-D	4169	†Variable Equalizer (Black Finish).....	150.00	51
56-E	4162	†Line Equalizer (Black Finish).....	40.00	51
XT-2830	4903	Microphone Input Transformer.....	20.00	52
XT-2771	4902	Mixing Transformer.....	15.50	52
XT-2769	4900	Line Transformer.....	14.00	52
XT-2770	4901	Bridging Transformer.....	15.50	52
XT-2831	4904	Loudspeaker Transformer.....	10.00	52
	4308-A	Relay Rectifier, 12 volt, 1 amp. (Black).....	40.00	52
	4308-C	Relay Rectifier, 12 volt, 1 amp (Umber Gray).....	40.00	52
		One set of tubes for MI-4308 (Stock No. 20801).....	4.00	52
64-B	4400B/4410	Cabinet (Black Finish) with Speaker Unit.....	70.00	53
64-B	4400C/4410	Cabinet (Walnut Finish) with Speaker Unit.....	75.00	53
64-B	4400/4410	Cabinet (Umber Gray Finish) with Speaker Unit.....	70.00	53
64-B	4400A/4410	Cabinet (Transmitter Gray) with Speaker unit.....	70.00	53
64-B	4405-A	Base Cabinet (Transmitter Gray).....	20.00	53
64-B	4405	Base Cabinet (Umber Gray).....	20.00	53
64-B	4405-B	Base Cabinet (Black).....	20.00	53
64-B	4405-C	Base Cabinet (Walnut).....	22.50	53
	4410	Speaker Unit for 64-B (Permanent Magnet) (Unmounted)...	24.00	53
	4466-A	Speaker Unit for 64-A (110 V. Field) (Unmounted).....	20.00	53
	4467	Speaker Unit for 64-A (56 V. Field) (Unmounted).....	20.00	53
	4433	°Grill and Diffuser for 64-A (Black finish).....	10.75	53
	4431	Grill and Diffuser for 64-A (Umber Gray finish).....	10.75	53
64-A	4437	°Base Cabinet for 64-A (Black Finish).....	20.00	53
79-A	4354	Field Supply Unit (110 Volt).....	17.50	53
UZ-4209	4460	Loudspeaker Unit (unmounted).....	15.00	53
UZ-4309	4461-A	Loudspeaker Unit (unmounted).....	20.00	53
	32200	Cueing Speaker (unmounted).....	7.95	53
	6294	Cueing Speaker housing (Walnut Finish).....	5.35	53
TRANSCRIPTION TURNTABLE EQUIPMENT				
70-C	4871	Transcription Turntable (Black & Silver) 60 cycle.....	325.00	54
70-C	4871-A	Transcription Turntable (Umber Gray) 60 cycle.....	325.00	54
70-C	4872	Transcription Turntable (Black & Silver) 50 cycle.....	340.00	54
71-B-1	4852-B	Vertical Tonearm Attachment for 70-A and 70-B.....	95.00	55
71-C	4867	Vertical Tonearm Attachment for 70-C.....	95.00	54
	4855	Booster Kit for Vertical Tonearms, Complete.....	62.50	55
	4171-25	Pad (16 db. 250 ohm).....	5.50	55
	4868	Hardware.....	5.00	55
	4303	Power Supply.....	23.50	55
	11207	85-B Pre-Amplifier, less tubes (see listing page 42).....		
	4898	Frequency Equalizer Kit for 71-A and 71-B.....	10.00	55
72-C	4877	Recording Attachment.....	120.00	55
	4876	Outside in lead screw for 72-C.....	25.00	
	4899	Extra Mounting Base for 72-C.....	5.50	

†For Umber Gray or Transmitter Gray Finish, add \$2.50.

°For Transmitter Gray Finish, add \$1.50.

Type Number	Master Item No.	TRANSCRIPTION TURNTABLE EQUIPMENT (Continued)	Net Price	Catalog Page
	4897	Driver Insert for 72-B Recorder.....	.75	56
	4861	Tone Arm Lift Mechanism for 70-B or MI-4857.....	3.75	56
	4879-A	Steel Recording Styli—package of 6.....	1.20	56
	4878-A	Sapphire Recording Styli.....	3.60	56
Code 803-5		Recording Disc 10" diameter .036" thick.....	.53	56
806-5		Recording Disc 12" diameter .036" thick.....	.67	56
808-5		Recording Disc 16" diameter .036" thick.....	1.20	56
808-6		Recording Disc 16" diameter .050" thick.....	1.33	56
	15889	Record Weight.....	2.80	56
	4888	Cutter Float Stabilizer for 72-B.....	14.00	57
	4887	High Fidelity Recording Head.....	175.00	57

FIELD AMPLIFIER EQUIPMENT

OP-5	4223-C	Portable Amplifier (250 ohms).....	295.00	58
OP-5X	4223-G	Portable Amplifier with vu meter (50 ohms).....	325.00	58
OP-5X	4223-E	Portable Amplifier with vu meter (250 ohms).....	325.00	58
	10651	One set of tubes for OP-5 (includes 2 meter lamps).....	9.40	58
	10801	Set of batteries for OP-5.....	10.83	
	11600	Fabric Cover for OP-5.....	10.00	58
OP-6	11202	Portable amplifier less vu meter.....	95.00	
	MI-11214	Battery box for OP-6 (including cable).....	25.00	
	11251	vu meter kit for OP-6.....	40.00	
		Set of tubes for OP-6.....	8.30	
		Fabric cover for OP-6.....	8.00	
62-A	{4221-B	Portable Amplifier (Hubbell Sockets) }.....	175.00	59
	{4306			
62-A	{4221-C	Portable Amplifier (Cannon Sockets) }.....	200.00	59
	{4306			
		One set of tubes for 62-A.....	20.53	59
	4221-B	62-A Amplifier <i>only</i> (Hubbell Sockets).....	130.00	59
	4221-C	62-A Amplifier <i>only</i> (Cannon Sockets).....	155.00	59
		One set of tubes for Amplifier Unit.....	16.00	59
	4306	62-A Power Unit <i>only</i>	50.00	59
		One set of tubes for Power Unit.....	4.53	59
	4307	Battery Box for 62-A.....	12.00	59

BROADCAST TRANSMITTERS

250-D	7131	250 Watt Transmitter.....	On application	66
100-H	7004	100 Watt Transmitter (Same as 250-D except tube complement).....	On application	66
1-E	7122	1000 Watt Transmitter.....	On application	67
5-D	7212-A	5000 Watt Transmitter.....	On application	68
10-D	7304	10,000 Watt Transmitter.....	On application	69
5-DX	7232	5000 Watt Transmitter.....	On application	70
....	7467	Extra crystal, holder and thermostat assembly for 250-G, 100-G, 1-G.....	On application	70
50-D	7351	50,000 Watt Transmitter.....	On application	72
250-G	7130	250 Watt Transmitter.....	On application	75
100-G	7003	100 Watt Transmitter (same as 250-G except tube complement).....	On application	75
1-G	7123	1000 Watt Transmitter.....	On application	75
....	7127	Power change panel for 1-G transmitter.....	On application	76
ET-4315	7005	Battery Operated, 15 Watt Mobile UHF Transmitter.....	On application	77
ET-4315	7006	AC Operated, 15 Watt Mobile UHF Transmitter.....	On application	77
250-K	7242	250 Watt Transmitter.....	On application	

TRANSMITTER ACCESSORIES

....	7113-A	Line Voltage Control Unit.....	On application	79
AZ-4293	7423	1 KW. Antenna Tuning Unit.....	275.00	79
92-A	7112	Lighting Choke Coil, less condensers and transformer.....	30.00	79
105	7444	5 KW. Antenna Tuning Unit.....	On application	80
	7237	Supervisory Control Console.....	On application	81
		Quartz crystals and holders.....	On application	108

CATHODE RAY OSCILLOGRAPHS

304-A	8201	9" Cathode Ray Oscillograph, including 1 set tubes.....	440.00	89
305-A	8200	9" Special Cathode Ray Oscillograph, including 1 set tubes... ..	2,225.00	90
	Stock 160	5" Cathode Ray Oscillograph, including 1 set tubes.....	130.00	90

Type Number	Master Item No.	CATHODE RAY OSCILLOGRAPHS (Continued)	Net Price	Catalog Page
	Stock 9641	3" Special Cathode Ray Oscillograph,		
	MI-7530	including 1 set tubes.....	110.00	90
	Stock 155	3" Standard Cathode Ray Oscillograph, including 1 set tubes	63.95	91
	Stock 151-2	2" Cathode Ray Oscillograph, including 1 set tubes.....	49.95	91
	Stock 151	1" Cathode Ray Oscillograph, including 1 set tubes.....	39.95	91
GENERAL PURPOSE METERS				
TMV-178	Stock 9819	Ultra Sensitive DC Meter.....	185.00	92
	MI-7521			
302-A	7546	Wide Radio Logarithmic Audio Meter, including 1 set tubes..	150.00	92
POWER SUPPLIES				
310-A	7524	Regulated Power Unit, including 1 set tubes.....	43.50	93
93-A	7519	Vibrator Power Unit, including 1 tube.....	80.00	93
	Stock 9785	Vibrator Power Supply.....	80.00	93
580-A		Regulated Power Unit (less tubes).....	115.00	94
582-A		Filter Panel.....	20.00	94
	MI-3526	Regulated Power Supply (less tubes).....	85.00	94
	MI-I500-A1	Filament Supply Unit (less tubes).....	181.50	94
	Stock 9796	Voltage Regulating Transformer.....	40.00	94
AF & RF MEASURING EQUIPMENT				
68-B	MI-7511-A	Beat Frequency Oscillator,		
		including 1 set tubes. Rack Mounting (Black Finish)...	225.00	95
	MI-7511-B	Beat Frequency Oscillator,		
		including 1 set tubes. Rack Mounting (Transmitter Gray)	228.00	95
	MI-7511-C	Beat Frequency Oscillator,		
		including 1 set tubes. On portable cabinet (Black).....	225.00	95
	MI-7511-D	Beat Frequency Oscillator		
		including 1 set of tubes. Rack Mounting (Umber Gray) ..	225.00	96
		One set of tubes.....	6.50	
69-B	MI-7512-A	Distortion Meter,		
		including 1 set tubes. Rack Mounting (Black Finish)...	200.00	96
	MI-7512-B	Distortion Meter, including 1 set tubes. Rack mounting.		
		(Transmitter Gray).....	203.00	96
	MI-7512-C	Distortion Meter including 1 set tubes. Cabinet Type (Black)	210.00	
	MI-7512-D	Distortion Meter including 1 set of tubes. Rack Mounting		
		(Umber Gray).....	200.00	96
	7514	Cabinet for MI-7512 (Black).....	15.00	96
		One set of tubes.....	3.30	
89-B	7515-B	°Attenuator Panel (Black). This is similar to 89-A except		
		Meter Calibrated with 1 mw zero level.....	145.00	97
	7515-C	°Same as 7515-B except Transmitter Gray Finish.....	145.00	97
	7520	Cabinet for 89B (Black).....	12.00	97
13-D	4161	*Volume Indicator (less tubes) (Black Finish).....	140.00	97
		One set of tubes.....	2.35	
303-A	7531	†Frequency Limit Monitor. Rack mounting (Umber Gray) in-		
		cluding 1 set tubes, less Crystal.....	187.50	98
		One set of tubes.....	6.95	
	7531-A	Frequency Limit Monitor. Cabinet mounting, including 1 set		
		tubes (Umber Gray Finish).....	200.00	98
		Crystal for 303A.....	50.00	98
66-A	7502	*Modulation Monitor. Rack mounting. (Black) 1 set tubes...	203.00	99
		One set of tubes.....	3.40	
	7504	Cabinet for 66-A (Black).....	12.00	99
300-A	7540-A	*Phase Meter, including 1 set tubes (Black).....	275.00	99
300-B	MI-8217	Three Element Array Kit.....	60.00	
	MI-8216	Remote Antenna, Current Indicator Panel.....	190.00	
301-A	8208	UHF Field Intensity Meter. Complete power supply, tubes		
		and accessories (see p. 92 reference for 302-A noise meter)	950.00	100
		One set of tubes.....	13.15	
* For Umber Gray or Transmitter Gray Finish, add \$3.00.				
° For Umber Gray Finish, add \$3.00.				
† For Black or Transmitter Gray, add \$3.00.				

Type Number	Master Item No.	AF & RF MEASURING EQUIPMENT (Continued)	Net Price	Catalog Page
302-A	7546	Wide Radio Logarithmic Audio Meter including 1 set of tubes	150.00	92
		One set of tubes.....	3.55	
306-A	8210	†Audio Frequency Meter. Rack mounting (Umber Gray), including 1 set tubes.....	240.00	106
306-A	8210-B	Rack Mounting (Black).....	240.00	106
306-A	8210-A	Cabinet Mounting (Umber Gray).....	250.00	106
		One set of tubes.....	7.25	
311-A	MI-8211	Broadcast Frequency Monitor. Rack Mounting (Black Finish) including 1 set of tubes.....	560.00	
311-A	MI-8211-A	Broadcast Frequency Monitor. Rack Mounting, including 1 set of tubes (Umber Gray or Transmitter Gray Finish).....	570.00	
		One set of tubes.....	11.75	
312-A	MI-8219	RF Noise Meter, including 1 set of tubes.....	200.00	

TELEVISION MEASURING EQUIPMENT

350-A	7538	Square Wave Generator, complete with tubes.....	400.00	102
351-A	7543	Video Sweep Oscillator, including tubes.....	400.00	102
352-A	8207	RF and IF Sweep Oscillator, including tubes and crystal.....	490.00	103
353-A	8205	Sweep Rectifier (less tube).....	20.00	103
		One set of tubes for 353-A.....	3.00	
560-A		Synchronizing Generator, including 560-A and 561-A less tubes	3600.00	103

INDUSTRIAL MEASURING EQUIPMENT

307-A1	7506-A1	Pressure Conversion Unit.....	120.00	104
307-A2	7506-A2	Pressure Conversion Unit.....	120.00	104
	Stock 9784	MI-7534 Amplifier, including 1 set of tubes.....	250.00	105
	Stock 9786	MI-7536 Synchronizer.....	130.00	105
	Stock 9796	MI-7537 Voltage Regulating Transformer.....	40.00	105
	Stock 9765	MI-7533-3 Vibration Pickup.....	25.00	106
	9787	MI-8214 Vibration Pickup Calibrator.....	30.00	106

† For Black or Transmitter Gray, add \$3.00.

Faradon Condensers

Listing of net prices to broadcasting stations by UC numbers. See full listing in catalog, Pages 123-126.

UC Model	Net Price	UC Model	Net Price	UC Model	Net Price	UC Model	Net Price	UC Model	Net Price	UC Model	Net Price
2325A	\$26.40	3000	\$40.80	3042	\$40.80	3086	\$4.40	3120	\$4.40	3244	\$168.00
2344	26.40	3004	4.80	3043	96.00	3087	4.80	3121	4.80	3245	308.80
2355A	26.40	3005	14.40	3045	4.40	3088	14.40	3122	14.40	3246	308.80
2360A	26.40	3006	15.20	3046	4.80	3089	15.20	3123	15.20	3247	308.80
2366	26.40	3008A	40.80	3047	14.40	3091	40.80	3124	26.40	3248	308.80
2373A	26.40	3009A	96.00	3048	15.20	3092	96.00	3125	40.80	3249	216.00
2374A	26.40	3011	4.40	3050	40.80	3094	4.40	3126A	4.40	3250	216.00
2446	26.40	3012	4.80	3053	4.40	3095B	4.80	3127A	4.80	3251	216.00
2455	26.40	3013	14.40	3054	4.80	3096	14.40	3128	14.40	3252	216.00
2478	26.40	3014	15.20	3055A	14.40	3097	15.20	3129A	15.20	3253	216.00
2507	96.00	3016	26.40	3056	15.20	3099	40.80	3130A	26.40	3254	216.00
2551A	26.40	3017A	40.80	3061	4.40	3100	96.00	3131A	40.80	3255	216.00
2663A	26.40	3018A	96.00	3062A	4.80	3102A	4.40	3132	4.40	3256	216.00
2979	40.80	3020	4.40	3063	14.40	3103	4.80	3133	4.80	3260	37.00
2980	4.80	3021	4.80	3064	15.20	3104	14.40	3192A	216.00	3272	14.00
2981	15.20	3022	14.40	3066	26.40	3105	15.20	3198A	96.00	3278	27.00
2983	4.40	3023	15.20	3067	40.80	3106	26.40	3202	4.40	3279	27.00
2984	4.80	3025	26.40	3068A	96.00	3107	40.80	3204	27.00	3286	27.00
2985	14.40	3026A	40.80	3070	4.40	3108	4.40	3222A	40.80	3287	37.00
2986	15.20	3027	96.00	3071	4.80	3109	4.80	3233	188.00	3288	37.00
2988	26.40	3029	4.40	3072	14.40	3110	14.40	3234	188.00	3289	37.00
2989	4.40	3030	4.80	3073	15.20	3111	15.20	3235	188.00	3290	37.00
2990A	4.80	3031A	14.40	3075	40.80	3112	26.40	3236	188.00	3291	37.00
2991	14.40	3032	15.20	3076	96.00	3113A	40.80	3237	188.00	3292	27.00
2992	15.20	3034A	40.80	3078	4.40	3114	4.40	3238	188.00	3294	27.00
2994	40.80	3035	96.00	3079	4.80	3115	4.80	3239	188.00	3295	27.00
2995	4.40	3037	4.40	3080	14.40	3116	14.40	3240	188.00	3296	27.00
2996	4.80	3038	4.80	3081	15.20	3117	15.20	3241	188.00		
2997	14.40	3039	14.40	3083	40.80	3118	26.40	3242	168.00		
2998	15.20	3040	15.20	3084	96.00	3119	40.80	3243	168.00		



POWER TUBES AND SPECIAL PURPOSE TUBES

Catalog pages 130-133

AIR-COOLED TYPES

	Net Price
RCA-203A	\$10.00
" 204A	85.00
" 211	10.00
" 800	10.00
" 801-A	3.45
" 802	3.50
" 803	28.50
" 804	15.00
" 805	13.50
" 806	22.00
" 807	3.50
" 808	7.75
" 809	2.50
" 810	13.50
" 811	3.50
" 812	3.50
" 813	28.50
" 814	17.50
" 828	17.50
" 829	28.75
" 830-B	10.00
" 832	28.75
" 833	85.00
" 834	12.50
" 837	7.50
" 838	11.00
" 841	3.25
" 842	3.25
" 843	12.50
" 844	18.00
" 845	10.00
" 849	120.00
" 850	37.50
" 851	350.00
" 852	16.40
" 860	32.50
" 861	195.00
" 865	12.75
" 891-R*	410.00
" 892-R*	410.00

* Credit of \$100.00 allowed for return of radiator and crate in good condition.

WATER-COOLED TYPES

RCA-207	\$300.00
" 846	300.00
" 858	450.00
" 862	1650.00
" 887	150.00
" 888	150.00
" 889	275.00
" 891	285.00
" 892	285.00
" 893	750.00
" 898	1650.00

RECTIFIERS

	Net Price
RCA-217-A	\$20.00
" 217-C	20.00
" 836	11.50
" 857-B	240.00
" 866	1.50
" 866-A	2.50
" 869-A	125.00
" 871	7.50
" 872	9.00
" 872-A	11.00
" 1616	5.75

CATHODE-RAY TYPES AND KINESCOPES

3AP1/906-P1	\$13.50
3AP4/906-P4	13.75
5AP4/1805-P4	22.00
5BP1/1802-P1	24.75
5BP4/1802-P4	22.00
7AP4	29.00
9AP4/1804-P4	50.00
12AP4/1803P4	60.00
RCA-902	7.50
" 904	52.50
" 905	45.00
" 907	48.75
" 908	18.00
" 909	49.00
" 910	21.25
" 913	4.00
" 914	85.00
" 1840	650.00
" 1848	525.00
" 1849	650.00
" 1850	650.00
" 1898	24.00
" 1899	95.00

CATHODE-RAY RECTIFIERS

RCA-878	\$11.00
" 884	2.00
" 885	2.00

PHOTOTUBES

RCA-868	\$3.70
" 917	4.75
" 918	4.50
" 919	4.75
" 920	5.25
" 921	2.00
" 922	2.00
" 923	2.60
" 924	2.00
" 925	2.00
" 926	3.00
" 927	3.70
" 928	2.00

MISCELLANEOUS

	Net Price
VR105/30	\$1.25
VR150/30	1.25
RCA-840	6.00
" 864	1.00
" 874	1.50
" 954 Acorn Type	5.00
" 955 Acorn Type	3.00
" 956 Acorn Type	5.00
" 957 Acorn Type	3.00
" 958 Acorn Type	3.00
" 959 Acorn Type	5.00
" 991	.90
" 1602	2.75
" 1603	4.75
" 1608	4.00
" 1609	1.60
" 1610	2.00
" 1612	3.25
" 1613	2.75
" 1614	3.50
" 1619	4.75
" 1620	2.50
" 1621	2.50
" 1622	2.75
" 1623	2.50
" 1624	4.75
" 1628	40.00
" 1851	2.10
" 2050	4.50
" 2051	2.50

SOCKETS, MOUNTINGS, JACKETS

UT-102-A	\$2.25
UT-103	12.50
UT-541-A	1.75
UT-542-A	1.50
UT-1085, -6	4.65
UT-1285-A(MI-7415)	35.00
UT-1289	310.00
UT-4289	21.50

GASKETS

PX-1178	\$.17
PX-1181	.98
PX-1281	.80

MISCELLANEOUS

MI-7422-A	2.95
MI-7432	2.30
Stock 16402}	Price on request
Stock 16679}	

RCA MANUFACTURING CO., Inc., Camden, N. J., U. S. A.

TRANSMITTER SALES OFFICES AT:

1270 SIXTH AVENUE
NEW YORK CITY

SANTA FE BUILDING
DALLAS, TEXAS

589 E. ILLINOIS STREET
CHICAGO, ILL.

1016 N. SYCAMORE STREET
HOLLYWOOD, CALIF.

530 CITIZENS & SOUTHERN BANK BLDG.
ATLANTA, GA.

170 NINTH STREET
SAN FRANCISCO, CALIF.

H. T. Neher

