

Radio Broadcast

Equipment Catalog

varian 

continental electronics division

**Continental's Customer Service . . .
*The Industry's Best!***

Call Anytime, Day Or Night.

**Main Offices:
(214) 381-7161**

**Parts:
(214) 388-3737**

**Engineering Service:
(214) 388-5800**

Telex: 73-398

FAX: (214) 381-4949

varian 

continental electronics division

4212 South Buckner Blvd., PO Box 270879
Dallas, Texas 75227 Ph: (214) 381-7161



INTRODUCTION

Continental Electronics, a Division of Varian Associates, Inc., is an engineering-oriented company that specializes in the design, development and production of low, medium and high power radio frequency transmitters for radio broadcast, communications, radar and scientific research applications.

The company was founded in 1946 with the express purpose of creating an extensive capability in RF product design.

Since its founding, Continental has established an unmatched record of achievement in the area of high power RF transmitters and amplifiers. Many of the company's innovations have advanced the state-of-the-art; most of its work has been of a pioneering type and the kind of work normally associated with the leading edge of technology.

Continental's commitment to excellence is reflected in the workmanship and operational performance of numerous radio/electronic products which bridge the spectrum from ELF to UHF, S-band and beyond, ranging in power from kilowatts to megawatts.

Continental broadcast transmitters are used throughout the world by commercial and government radio stations for local, regional and international broadcasting.

In addition to high power medium and shortwave broadcast transmitters, Continental offers broadcasters a complete line of AM mediumwave transmitters from 1,000 to 50,000 watts, and FM transmitters from 50 watts to 70,000 watts; transmitter combiners and diplexers, phasing and coupling systems, FM antennas, miscellaneous RF and studio equipment.

This catalog gives a brief product overview of the radio broadcast equipment available from Continental.

For performance data, specifications, pricing and delivery information, contact your local Continental sales representative (see pages 84-87).

PRODUCT WARRANTY

All products, specifications and prices in this catalog are subject to change without notice; all products are subject to prior sale; no guarantee as to product availability or performance is given or implied. Some products shown in this catalog are not manufactured by Continental; they are listed for the convenience of Continental's customers to show typical examples of RF-related equipment available in the marketplace. No endorsement or preferential treatment is given or implied for these products; any warranty or guarantee rests with the manufacturer of the product and not with Continental.

Contents

Transmitters

FM

Exciter	4
2.5 kW	5
3.8 kW	6
5 kW	7
11 kW	8
21.5 kW	9
25 kW	10
27.5 kW	11
35 kW	12
40 kW	13
50 kW	14
55 kW	15
60 kW	16
70 kW	17

AM

1 kW	19
5 kW	20
10 kW	21
50 kW	22
100 kW	23
150 kW	23
250 kW	24
500 kW	25
1,000 kW	26
2,000 kW	27

Shortwave

10 kW	28
50 kW	29
100 kW	30
250 kW	31
500 kW	32

Accessories

Transmitter Combiners	33-36
Transmitter Dummy Loads	37-38
Transmitter & Exciter Controls	39-40
Antenna Towers	42
Antenna Phasing & Coupling	43
FM Antennas	44-49
Antenna Deicers & Lights	50
Transmission Line	51-63

Appendix

Engineering Data	65-80
Broadcast Products & Accessories	82-83
Sales & Service	84-85
International Representatives	86-87

Transmitters

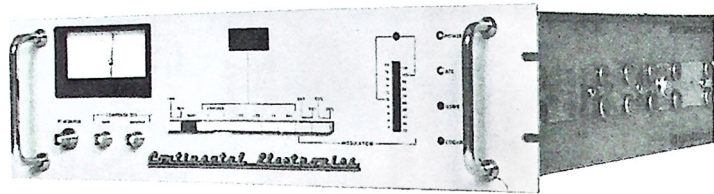

The Ultimate FM Exciter

Continental's Type 802A solid-state FM Exciter offers broadcasters outstanding performance, high-quality construction, outstanding reliability.

With its variable output of 5 to 50 watts and self-contained harmonic filter, the 802A can be used as a low power transmitter.

The 802A is completely solid-state. All sub-assemblies are modularized and fully accessible from the front.

All components of the 802A have been selected with proven reliability as well as electrical suitability as a prerequisite.

The 802A FM Exciter is fully equipped to accept the composite baseband signal from any fine quality stereo generator, and STL system or monaural audio and SCA programming.

SPECIFICATIONS 802A FM Exciter

GENERAL

Power Output:

5 to 50 watts
continuously adjustable

RF Output Impedance:

50 ohms, VSWR less than 2:1 for full output, protected for open and short circuit; BNC connector

RF Harmonic and Spurious:

60 dB or more below rated output

Frequency Range:

87 to 109 MHz in 10 kHz steps

Frequency Control:

Phase locked loop frequency synthesis from highly stable master oscillator

Frequency Stability:

±250 Hz

Modulation Type:

Direct carrier frequency modulation

Modulation Capability:

±200 kHz deviation

Modulation Indication:

Digital LED display shows true peak level of modulating signal in 5% increments with over-modulation indicator; illumination of each LED occurs at ±2% of indicated modulation level

MONAURAL OPERATION

Audio Input Impedance:

600 ohms, balanced

Audio Input Return Loss:

30 dB or better

Audio Input Level:

+10 dBm (6.93 volts peak to peak at 600 ohms) for ±75 kHz deviation

Audio Frequency Response:

±0.5 dB flat; 25, 50 or 75 microsecond pre-emphasis, 20 Hz to 15 kHz

Total Harmonic Distortion:

0.08% maximum; 20 Hz to 15 kHz (measured with spectrum analyzer)

Intermodulation Distortion:

0.08% maximum; 60 Hz/7 kHz, 4:1 ratio

Transient IMD:

0.1% maximum (square wave/sine wave)

FM S/N Ratio (FM Noise):

78 dB minimum below ±75 kHz deviation at 400 Hz, measured within a 20 Hz to 15 kHz bandwidth with 75 microsecond de-emphasis

Asynchronous AM S/N Ratio (AM Noise):

73 dB RMS below carrier; reference: 100% AM modulation, full power at 400 Hz with 75 microsecond de-emphasis, no FM modulation

Synchronous AM S/N Ratio (Incidental AM Noise):

65 dB below carrier; reference: 100% AM modulation, full power at 400 Hz with 75 microsecond de-emphasis, FM modulation ±75 kHz at 400 Hz

WIDEBAND OPERATION

Composite Inputs:

Balanced, unbalanced and test

Composite Input Impedance:

5,000 ohms, nominal

Composite Input Level:

1.25 volts RMS (3.54 volts peak to peak) for ±75 kHz deviation

Composite Amplitude Response:

±0.1 dB, 20 Hz to 100 kHz

Composite Phase Response:

±0.5° 20 Hz to 75 kHz

Composite Group Delay Variation:

±25 ns, 20 Hz to 75 kHz

Composite Total Harmonic Distortion:

0.08% maximum

Composite Intermodulation Distortion:

0.08% maximum; 60 Hz/7 kHz, 4:1 ratio

Composite Transient IMD:

0.1% maximum

Composite FM S/N Ratio (FM Noise):

78 dB minimum below ±75 kHz deviation

Two SCA Inputs:

Balanced or unbalanced

SCA Input Impedance:

15,000 ohms, nominal

SCA Input Level:

1.25 volts RMS for ±75 kHz deviation

SCA Amplitude Response:

±0.3 dB, 40 kHz to 100 kHz

STEREO OPERATION

Most stereo performance parameters are determined by the stereo generator used. The following parameters are influenced by the rf system. These specifications assume that the stereo generator is a state of the art generator.

Stereo Separation:

50 dB minimum; 50 Hz to 15 kHz (60 dB or better, 400 Hz to 7.5 kHz typical)

Total Harmonic Distortion:

0.08% maximum; 50 Hz to 15 kHz (measured with spectrum analyzer)

Intermodulation Distortion:

0.08% maximum; 60 Hz/7 kHz, 4:1 ratio

FM Noise:

-72 dB referenced to 400 Hz, 75 kHz deviation; measured with 75 microsecond de-emphasis within a 20 Hz to 15 kHz bandwidth

Linear Crosstalk:

-55 dB

SCA OPERATION

Most SCA performance parameters are determined primarily by the SCA generator used. The following parameters are influenced by the rf system. These specifications assume that the SCA generator is a state of the art generator.

Crosstalk, SCA to Main and Stereo:

(67 kHz and/or 92 kHz)
-60 dB, SCA deviation 5 kHz main, 75 microsecond de-emphasis

Crosstalk, Main and Stereo to SCA:

(67 kHz or 92 kHz)
-50 dB, main and stereo 75 kHz deviation; SCA reference deviation, 5 kHz and 200 Hz modulation; 150 microsecond SCA de-emphasis

Crosstalk, SCA to SCA:

(67 and 92 kHz)
-50 dB, SCA reference deviation 5 kHz and 200 Hz modulation frequency; 150 microsecond de-emphasis

ELECTRICAL

Input Power:

115V or 230V ± 10%; 50/60 Hz ± 5%; single phase, 200 watts maximum

OPERATING ENVIRONMENT

Temperature Range:

-20°C to +55°C (-4°F to +131°F)

Altitude Range:

0 to 15,100 ft. (0 to 4,600 M)

Relative Humidity Range:

0 to 95%

MECHANICAL

Mounting:

Equipped with rack mounting slides

Size:

17.5 inches wide (44.45cm), centered in a 19 inch wide (48.26cm) rack-mounting panel; 5.25 inches high (13.34cm); 22 inches deep (55.88cm)

Weight:

Approximately 31.5 lbs. (14.3 kg)

All specifications are subject to change without notice.

Type 814R-1

Continental's 814R-1 is a high performance, state-of-the-art transmitter that uses the Type 802A Exciter to deliver a crisp, clean signal.

The transmitter is solid-state except for the single 5CX1500B tube in the final amplifier. IC logic is used for all control functions. A computer-like memory restarts the transmitter after a power failure.

Standard features include remote control interface and an automatic overload/recycle system. The transmitter is completely self-contained in one small cabinet.

SPECIFICATIONS using Type 802A Exciter

GENERAL**Rated Power Output:**

814R-1: 2.5 kW

Power Consumption:

814R-1: 4.9 kW

Frequency Range:

88 to 108 MHz, in 10 kHz steps

Frequency Control:

Phase Locked Loop Frequency
Synthesis from high stability master
oscillator

Frequency Stability:

± 275 Hz

Output Impedance:

50 ohms

Output Connector:

1 1/2" EIA Flange

VSWR:

2:1, max.

Modulation Type:

Direct carrier frequency modulation

Modulation Capability:

± 150 kHz deviation

Modulation Indication:

Digital LED display shows true peak
level of modulating signal in 5%
increments with accuracy better
than ± 2%

Exciter:

Solid-state unit with variable output
of 5 to 50 watts, and self-contained
harmonic filter.

RF Harmonic Attenuation:

- 80 dB, min.

Power Supply Rectifiers:

Silicon

MONAURAL OPERATION**Audio Input Impedance:**

600 ohms, balanced

Audio Input Return Loss:

30 dB or better

Audio Input Level:

+ 10 dBm (6.93 volts peak-to-peak)
@ 600 ohms for ± 75 kHz deviation.

Audio Frequency Response:

± 0.5 dB; flat, 25, 50 or 75
microsecond pre-emphasis,
20 Hz to 15 kHz

Total Harmonic Distortion:

0.08% max.; 20 Hz to 15 kHz
(Measured with Spectrum Analyzer.)

Intermodulation Distortion:

0.1% or less, 60 Hz/7 kHz 4:1 ratio

FM S/N Ratio (FM Noise):

75 dB min. below ± 75 kHz
deviation @ 400 Hz, measured
within a 20 Hz to 15 kHz bandwidth
with 75 microsecond de-emphasis

**Asynchronous AM S/N Ratio
(AM Noise):**

55 dB RMS below carrier; reference:
100% AM modulation, full power @
400 Hz with 75 microsecond de-
emphasis, no FM modulation

**Synchronous AM S/N Ratio
(Incidental AM Noise):**

40 dB below carrier; reference:
100% AM modulation, full power @
400 Hz with 75 microsecond de-
emphasis, FM modulation ± 75 kHz
@ 400 Hz

WIDEBAND OPERATION**Composite Inputs:**

Balanced, unbalanced and test

Composite Input Impedance:

5,000 ohms, nominal

Composite Input Level:

1.25 volts RMS (3.54 volts peak to
peak) for ± 75 kHz deviation

Composite Amplitude Response:

± 0.1 dB, 20 Hz to 100 kHz

Composite Total Harmonic**Distortion:**

0.08% max

Composite Intermodulation**Distortion:**

0.1% or less, 60 Hz/7 kHz 4:1 ratio

Two SCA Inputs:

Balanced or unbalanced

SCA Input Impedance:

50,000 ohms, nominal

SCA Input Level:

1.25 volts RMS for ± 7.5 kHz
deviation

SCA Amplitude Response:

± 0.3 dB, 40 kHz to 100 kHz

STEREO OPERATION

Most Stereo performance parameters
are determined primarily by the Stereo
Generator used. The following
parameters are influenced by the RF
system. These specifications assume
that a "State-of-the-Art" Stereo
Generator is used.

Stereo Separation:

50 dB min.; 50 Hz to 15 kHz. (60 dB
or better, 400 Hz to 7.5 kHz typical)

Total Harmonic Distortion:

0.08% max.; 50 Hz to 15 kHz.
(Measured with Spectrum Analyzer.)

Intermodulation Distortion:

0.1% max.; 60 Hz/7 kHz, 4:1 ratio.

FM Noise:

- 72 dB referenced to 400 Hz, 75
kHz deviation. Measured with 75
microsecond de-emphasis within a
20 Hz to 15 kHz bandwidth.

Linear Crosstalk

- 55 dB

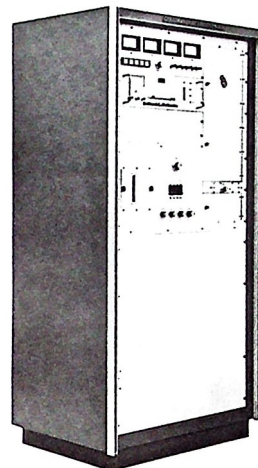
**SCA OPERATION**

Most SCA performance parameters are
determined primarily by the SCA gen-
erators used. The following parameters
are influenced by the RF System. These
specifications assume that a "State-of-
the-Art" SCA Generator is used.

**Crosstalk, SCA to Main and Stereo
(67 kHz and/or 92 kHz):**

- 60 dB, SCA deviation 5 kHz, Main
75 microsecond de-emphasis

**Crosstalk, Main and Stereo to SCA
(67 kHz or 92 kHz):**

- 50 dB, Main and Stereo 75 kHz
deviation; SCA reference deviation,
5 kHz and 200 Hz modulation; SCA
de-emphasis, 150 microsecond

**Crosstalk SCA to SCA
(67 kHz and 92 kHz):**

- 50 dB, SCA reference deviation 5 kHz
and 200 Hz modulation frequency;
de-emphasis, 150 microsecond

ELECTRICAL**Power Source:**

200 to 250 volts ac; 60 Hz, single
phase; available transformer taps
are 200, 210, 220, 230, 240, 250
volts ac; 50 Hz available on request.

Permissible Line Voltage Variation: ± 5%**Filament regulator: ± 1% of optimum****OPERATING ENVIRONMENT****Operating Altitude:**

7,500 ft. (2286 m) standard; optional to
10,000 ft (3048 m) with modification kit

Ambient Temperature Range:

- 20°C to + 50°C (- 4°F to + 122°F)

MECHANICAL**Size, as shown**

69" (175 cm) H
35" (89 cm) W
24" (61 cm) D

Weight:

750 lb (340 kg) nominal

All specifications are subject to change without notice.

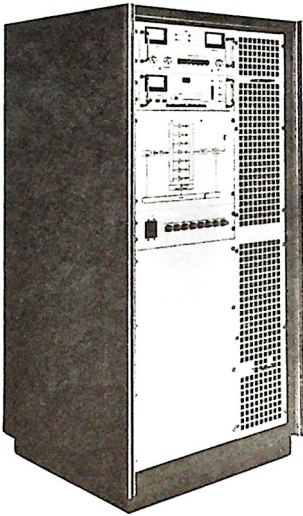

General Description

Continental's 814C is a compact, high performance transmitter that uses the 802A exciter to deliver a crisp, clean signal.

The transmitter design is based on a 700 watt broadband amplifier module and utilizes a splitter/combiner technique to achieve the rated output of 3,800 watts.

The RF chain consists of an 802A 50 watt solid-state exciter driving a solid-state amplifier module which serves as the IPA. The IPA output is split to drive the PA amplifier modules. The outputs of the PA modules are combined and treated as the transmitter's final power amplifier stage.

All modules are self-protected from excessive power supply voltage, VSWR overload, excessive drive power and high temperature.

A single-phase power supply powers all of the power modules. The power supply is fed by a pair of gated SCRs to allow control of the supply output voltage.

All transmitter controls, interface circuits and metering are housed in a self-contained control module which slides out on tracks for easy access. The control module provides access for local or remote operation.

Features

- Broadband Modular Design
- Transparent Audio Performance
- No Tuning
- 100% Solid-State
- Single-Phase Power Supply
- VSWR Protection Circuit
- 100% Self-Protected Solid-State Amplifier Modules
- Designed for Low Maintenance and Long Life
- Built-In Redundancy for Reliable Performance

SPECIFICATIONS using 802A solid-state exciter

GENERAL

Rated Power Output:
3.8 kW

Frequency Range:
88 to 108 MHz, in 10 kHz steps

Frequency Control:
Phase-locked loop frequency synthesis from high stability master oscillator

Frequency Stability:
 ± 250 Hz, 0-55°C

Output Impedance:
50 ohms

Output Connector:
1-5/8" EIA flange

VSWR:

2:1, maximum

Modulation Type:
Direct carrier frequency modulation

Modulation Capability:
 ± 150 kHz deviation

Modulation Indication:
Digital LED display shows true peak level of modulation signal in 5% increments with accuracy better than $\pm 2\%$

Exciter:
Solid-state unit with variable output of 5 to 50 watts; self-contained harmonic filter

RF Harmonic Attenuation:
-80 dB, minimum

Power Supply Rectifiers:
Silicon

MONAURAL OPERATION

Audio Input Impedance:
600 ohms, balanced

Audio Input Return Loss:
30 dB or better

Audio Input Level:
+10 dBm (6.93 V peak-to-peak) at 600 ohms for ± 75 kHz deviation

Audio Frequency Response:
 ± 0.5 dB; flat, 25, 50 or 75 microsecond pre-emphasis, 20 Hz to 15 kHz

WIDEBAND OPERATION

Composite Inputs:
Balanced, unbalanced and test

Composite Input Impedance:
5,000 ohms, nominal

Composite Input Level:
1.25 V RMS (3.54 V peak-to-peak) for ± 75 kHz deviation

ELECTRICAL

Power Source:
200 to 250 VAC; 60 Hz single phase; available transformer taps are 200, 210, 220, 230, 240, 250 VAC; 50 Hz is available on request

Permissible Line Voltage Variation:
 $\pm 5\%$

OPERATING ENVIRONMENT

Altitude:
7,500 ft (2,286 m) standard; optional to 10,000 ft (3,048 m) with modification kit

Ambient Temperature Range:
-20°C to +50°C (-4°F to + 122°F)

Relative Humidity:
0 to 95%

MECHANICAL

Transmitter:
69" (175 cm) H
34 $\frac{3}{4}$ " (88 cm) W
33 $\frac{3}{8}$ " (61 cm) D

Weight:
Approximately 1,000 lb (450 kg)

All specifications are subject to change without notice.

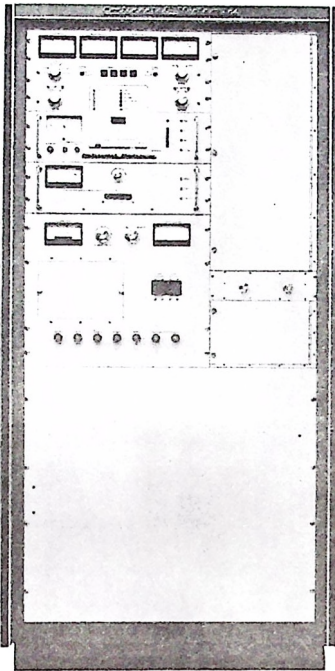

Type 815A

Continental's 815A is a high performance, state-of-the-art transmitter that uses the Type 802A Exciter to deliver a crisp, clean signal.

The transmitter is solid-state, including a 120 watt intermediate power amplifier, except for a single 4CX3500A tube in the final amplifier. IC logic is used for all control functions. A computer-like memory, powered by battery backup, restarts the transmitter after a power failure.

Standard features include remote control, interface overload/recycle system, filament voltage regulation, automatic RF power control, and SWR foldback.

The transmitter is completely self-contained in one small cabinet, including harmonic filter.

SPECIFICATIONS using 802A solid-state exciter

GENERAL

Rated Power Output:
5 kW

Power Consumption:
9.8 kW, nominal

Frequency Range:
88 to 108 MHz, in 10 kHz steps

Frequency Control:
Phase-locked loop frequency synthesis from high stability master oscillator

Frequency Stability:
±250 Hz

Output Impedance:
50 ohms

Output Connector:
1-5/8" EIA flange

VSWR:
2:1, maximum

Modulation Type:

Direct carrier frequency modulation

Modulation Capability:

±150 kHz deviation

Modulation Indication:

Digital LED display shows true peak level of modulated signal in 5% increments with accuracy better than ±2%

Exciter:

Solid-state unit with variable output of 5 to 50 watts; has self-contained harmonic filter

RF Harmonic Attenuation:

-80 dB, minimum

Power Supply Rectifiers:

Silicon

MONAURAL OPERATION

Audio Input Impedance:

600 ohms, balanced

Audio Input Return Loss:

30 dB or better

Audio Input Level:

+10 dBm (6.93 V peak-to-peak) at 600 ohms for ±75 kHz deviation

Audio Frequency Response:

±0.5 dB; flat, 25, 50 or 75 microsecond pre-emphasis, 20 Hz to 15 kHz

Total Harmonic Distortion:

0.08% maximum; 20 Hz to 15 kHz (Measured with spectrum analyzer)

Intermodulation Distortion:

0.08% or less, 60 Hz to 7 kHz, 4:1 ratio

FM S/N Ratio (FM Noise):

75 dB minimum below ±75 kHz deviation at 400 Hz, measured within a 20 Hz to 15 kHz bandwidth with 75 microsecond de-emphasis

Asynchronous AM S/N Ratio (AM Noise):

55 dB RMS below carrier; reference: 100% AM modulation, full power, with 75 microsecond de-emphasis, no FM modulation

Synchronous AM S/N Ratio (Incidental AM Noise):

50 dB below carrier; reference: 100% AM modulation, full power, with 75 microsecond de-emphasis, FM modulation ±75 kHz at 400 Hz

WIDEBAND OPERATION

Composite Inputs:

Balanced, unbalanced and test

Composite Input Impedance:

5,000 ohms, nominal

Composite Input Level:

1.25 V RMS (3.54 V peak-to-peak) for ±75 kHz deviation

Composite Amplitude Response:

±0.1 dB, 20 Hz to 100 kHz

Composite Total Harmonic Distortion:

0.1% maximum

Composite Intermodulation Distortion:

0.08% or less, 60 Hz to 7 kHz, 4:1 ratio

Two SCA Inputs:

Balanced or unbalanced

SCA Input Impedance:

15,000 ohms, nominal

SCA Input Level:

1.25 V RMS for ±75 kHz deviation

SCA Amplitude Response:

±0.3 dB, 40 kHz to 100 kHz

STEREO OPERATION

Most stereo performance parameters are determined primarily by the stereo generator used. The following specifications are influenced by the RF system and assume that a state-of-the-art stereo generator is used.

Stereo Separation:

50 dB minimum; 50 Hz to 15 kHz (60 dB or better, 400 Hz to 7.5 kHz typical)

Total Harmonic Distortion:

0.08% maximum; 50 Hz to 15 kHz (Measured with spectrum analyzer)

Intermodulation Distortion:

0.15% maximum; 60 Hz to 7 kHz, 4:1 ratio

FM Noise:

-70 dB referenced to 400 Hz, 75 kHz deviation. Measured with 75 microsecond de-emphasis within a 20 Hz to 15 kHz bandwidth

Linear Crosstalk:

-55 dB

SCA OPERATION

Most SCA performance parameters are determined primarily by the SCA generator used. The following specifications are influenced by the RF system and assume that a state-of-the-art SCA generator is used.

Crosstalk, SCA to Main and Stereo (67 kHz and/or 92 kHz):

-60 dB, SCA deviation 5 kHz, main 75 microsecond de-emphasis

Crosstalk, Main and Stereo to SCA (67 kHz and/or 92 kHz):

-50 dB, main and stereo 75 kHz deviation; SCA reference deviation, 5 kHz and 200 Hz modulation; SCA de-emphasis, 150 microsecond

Crosstalk SCA to SCA (67 kHz and/or 92 kHz):

-50 dB, SCA reference deviation 5 kHz and 200 Hz modulation frequency; de-emphasis, 150 microsecond

ELECTRICAL

Power Source:

200 to 250 VAC; 60 Hz, single-phase; available transformer taps are 200, 210, 220, 230, 240, 250 VAC; 50 Hz available on request

Permissible Line Voltage Variation:

±5%

Filament Regulator:

±1% of optimum

OPERATING ENVIRONMENT

Altitude:

7,500 ft (2,286 m) standard; optional to 10,000 ft (3,048 m) with modification kit

Ambient Temperature Range:

-20°C to +50°C (-4°F to +122°F)

Relative Humidity:

0 to 95%

MECHANICAL

Transmitter:

69" (175 cm) H

34 3/4" (88 cm) W

33 3/8" (61 cm) D

Weight:

1,020 lbs (466 kg) nominal

All specifications are subject to change without notice.

GENERAL

Rated Power Output:
11 kW (11.5 kW Max.)

Power Consumption
18.5 kW, nom. (at 10 kW)

Frequency Range:
88 to 108 MHz, in 10 kHz steps

Frequency Control:
Phase locked loop frequency synthesis from high stability master oscillator

Frequency Stability:
± 250 Hz

Output Impedance:
50 ohms

Output Connector:
3/8" EIA Flange

VSWR:
2:1, max.

Modulation Type:
Direct carrier frequency modulation

Modulation Capability:
± 150 kHz deviation

Modulation Indication:
Digital LED display shows true peak level of modulated signal in 5% increments with accuracy better than ± 2%

Exciter:
Solid-state unit with variable output of 5 to 50 watts; has self-contained harmonic filter

RF Harmonic Attenuation:
- 80 dB, min.

Power Supply Rectifiers:
Silicon

MONAURAL OPERATION

Audio Input Impedance:
600 ohms, balanced

Audio Input Return Loss:
30 dB or better

Audio Input Level:
+ 10 dBm (6.93 volts, peak-to-peak) at 600 ohms for ± 75 kHz deviation

Audio Frequency Response
± 0.5 dB; flat, 25, 50 or 75 microsecond pre-emphasis, 20 Hz to 15 kHz

Total Harmonic Distortion:
0.08% max.; 20 Hz to 15 kHz (measured with spectrum analyzer)

Intermodulation Distortion:
0.08% or less, 60 Hz to 7 kHz, 4:1 ratio

FM S/N Ratio (FM Noise):
75 dB min. below ± 75 kHz deviation at 400 Hz, measured within a 20 Hz to 15 kHz bandwidth with 75 microsecond de-emphasis

Asynchronous AM S/N Ratio (AM Noise):
55 dB RMS below carrier; reference: 100% AM modulation, full power at 400 Hz with 75 microsecond de-emphasis, no FM modulation

Synchronous AM S/N Ratio (Incidental AM Noise):
50 dB below carrier; reference: 100% AM modulation, full power at 400 Hz with 75 microsecond de-emphasis, FM modulation ± 75 kHz at 400 Hz microsecond pre-emphasis, 20 Hz to 15 kHz

Total Harmonic Distortion:
0.08% maximum; 20 Hz to 15 kHz (Measured with spectrum analyzer)

Intermodulation Distortion:
0.08% or less, 60 Hz/7 kHz, 4:1 ratio

WIDEBAND OPERATION

Composite Inputs:
Balanced, unbalanced and test

Composite Input Impedance:
5,000 ohms, nom.

Composite Input Level:
1.25 volts RMS (3.54 volts peak-to-peak) for ± 75 kHz deviation

Composite Amplitude Response:
± 0.1 db, 20 Hz to 100 kHz

Composite Total Harmonic Distortion:
.08% max.

Composite Intermodulation Distortion:
.08% or less, 60 Hz to 7 kHz, 4:1 ratio

Two SCA Inputs:
Balanced or unbalanced

SCA Input Impedance:
15,000 ohms, nom.

SCA Input Level:
1.25 volts RMS for ± 7.5 kHz deviation

SCA Amplitude Response:
± 0.3 dB, 40 kHz to 100 kHz

STEREO OPERATION

Most Stereo performance parameters are determined primarily by the Stereo Generator used. The following specifications are influenced by the RF system and assume that a state-of-the-art stereo generator is used.

Stereo Separation:
50 dB min.; 50 Hz to 15 kHz (60 dB or better, 400 Hz to 7.5 kHz typical)

Total Harmonic Distortion:
0.08% max.; 50 Hz to 15 kHz (measured with spectrum analyzer)

Intermodulation Distortion:
0.08% max.; 60 Hz to 7 kHz, 4:1 ratio

FM Noise:
- 7 dB referenced to 400 Hz, 75 kHz deviation. Measured with 75 microsecond de-emphasis within a 20 Hz to 15 kHz bandwidth.

Linear Crosstalk:
- 55 dB

SCA OPERATION

Most SCA performance parameters are determined primarily by the SCA generator used. The following specifications are influenced by the RF System and assume that a state-of-the-art SCA generator is used.

Crosstalk, SCA to Main and Stereo (67 kHz and/or 92 kHz):
- 60 dB, SCA deviation 5 kHz, Main 75 microsecond de-emphasis

Crosstalk, Main and Stereo to SCA (67 kHz and/or 92 kHz):
- 50 dB, Main and Stereo 75 kHz deviation; SCA reference deviation; 5 kHz and 200 Hz modulation; SCA de-emphasis, 150 microsecond

Crosstalk SCA to SCA (67 kHz and/or 92 kHz):
- 50 db, SCA reference deviation; 5 kHz and 200 Hz modulation frequency; de-emphasis, 150 microsecond

ELECTRICAL

Power Source:
200 to 250 volts ac; 60 Hz, three phase; available transformer taps are 200, 210, 220, 230, 240, 250 volts ac; 50 Hz available on request

Permissible Line Voltage Variation:
± 5%

Filament Regulator:
± 1% of optimum

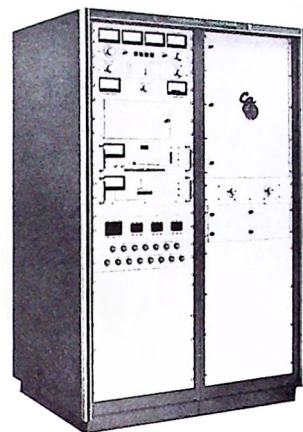

OPERATING ENVIRONMENT

Altitude Range:
0 to 7,500 ft. (0 to 2286 m) standard; optional to 10,000 ft. (3048 m) with modification kit

Ambient Temperature Range:
- 20°C to + 50°C (- 4°F to + 122°F)

Relative Humidity:
0 to 95%

MECHANICAL

Size, as shown:
69" (175.26 cm) H x 45" (114.3 cm) W x 34" (86.36 cm) D

Weight:
1200 lb. (544 kg), est.

All specifications are subject to change without notice.

Preliminary

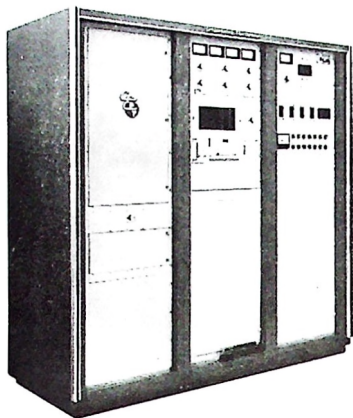

Type 816R-2B

Continental's 816R-2B is a high performance, state-of-the-art transmitter that uses the Type 802A Exciter to deliver a crisp, clean signal.

The 816R-2B is solid-state except for one tube: a 4CX15000A power amplifier operating at Class C.

Standard features include remote control equipment and an automatic overload/recycle system. The transmitter is completely self-contained in one small cabinet, including harmonic filter.

SPECIFICATIONS using 802A solid-state exciter

GENERAL

Rated Power Output:

- 816R-2B: 21.5 kW
- 816R-3B: 25 kW
- 816R-4B: 27.5 kW

Power Consumption:

- 816R-2B: 33 kW nominal
- 816R-3B: 40 kW nominal
- 816R-4B: 42 kW nominal

Frequency Range:

88 to 108 MHz, in 10 kHz steps

Frequency Control:

Phase-locked loop frequency synthesis from high stability master oscillator

Frequency Stability:

±250 Hz

Output Impedance:

50 ohms

Output Connector:

3/8" EIA flange

VSWR:

2:1, maximum

Modulation Type:

Direct carrier frequency modulation

Modulation Capability:

±150 kHz deviation

Modulation Indication:

Digital LED display shows true peak level of modulating signal in 5% increments with accuracy better than ±2%

Exciter:

Solid-state unit with variable output of 5 to 50 watts; self-contained harmonic filter

RF Harmonic Attenuation:

-80 dB, minimum

Power Supply Rectifiers:

Silicon

MONAURAL OPERATION

Audio Input Impedance:

600 ohms, balanced

Audio Input Return Loss:

30 dB or better

Audio Input Level:

+ 10 dBm (693 V peak-to-peak) at 600 ohms for ±75 kHz deviation

Audio Frequency Response:

±0.5 dB; flat, 25, 50 or 75 microsecond pre-emphasis, 20 Hz to 15 kHz

Total Harmonic Distortion:

0.08% maximum; 20 Hz to 15 kHz (Measured with spectrum analyzer)

Intermodulation Distortion:

0.08% or less, 60 Hz/7 kHz, 4:1 ratio

FM S/N Ratio (FM Noise):

75 dB minimum, below ±75 kHz deviation at 400 Hz, measured within a 20 Hz to 15 kHz bandwidth with 75 microsecond de-emphasis

Asynchronous AM S/N Ratio (AM Noise):

55 dB RMS below carrier; reference: 100% AM modulation, full power, with 75 microsecond de-emphasis, no FM modulation

Synchronous AM S/N Ratio (Incidental AM Noise):

50 dB below carrier; reference: 100% AM modulation, full power, with 75 microsecond de-emphasis, FM modulation ±75 kHz at 400 Hz

WIDEBAND OPERATION

Composite Inputs:

Balanced, unbalanced and test

Composite Input Impedance:

5,000 ohms, nominal

Composite Input Level:

1.25 V RMS (3.54 V peak-to-peak) for ±75 kHz deviation

Composite Amplitude Response:

±0.1 dB, 20 Hz to 100 kHz

Composite Total Harmonic Distortion:

0.08% maximum

Composite Intermodulation Distortion:

0.08% maximum; 60 Hz to 7 kHz, 4:1 ratio

Two SCA Inputs:

Balanced or unbalanced

SCA Input Impedance:

15,000 ohms, nominal

SCA Input Level:

1.25 V RMS for ±75 kHz deviation

SCA Amplitude Response:

±0.3 dB, 40 kHz to 100 kHz

STEREO OPERATION

Most stereo performance parameters are determined primarily by the stereo generator used. The following parameters are influenced by the RF system. These specifications assume that a state-of-the-art stereo generator is used.

Stereo Separation:

50 dB minimum; 50 Hz to 15 kHz (60 dB or better, 400 Hz to 7.5 kHz typical)

Total Harmonic Distortion:

0.08% maximum; 50 Hz to 15 kHz (Measured with spectrum analyzer)

Intermodulation Distortion:

0.08% maximum; 60 Hz to 7 kHz, 4:1 ratio

FM Noise:

-72 dB referenced to 400 Hz, 75 kHz deviation. Measured with 75 microsecond de-emphasis within a 20 Hz to 15 kHz bandwidth

Linear Crosstalk:

-55 dB

SCA OPERATION

Most SCA performance parameters are determined primarily by the SCA generator used. The following parameters are influenced by the RF system. These specifications assume that a state-of-the-art SCA generator is used.

Crosstalk, SCA to Main and Stereo (67 kHz and/or 92 kHz):

-60 dB, SCA deviation 5 kHz; main 75 microsecond de-emphasis

Crosstalk, Main and Stereo to SCA (67 kHz and/or 92 kHz):

-50 dB, main and stereo 75 kHz deviation; SCA reference deviation, 5 kHz and 200 Hz modulation; SCA de-emphasis, 150 microsecond

Crosstalk, SCA to SCA (67 kHz and/or 92 kHz):

-50 dB, SCA reference deviation; 5 kHz and 200 Hz modulation frequency, 150 microsecond de-emphasis

ELECTRICAL

Power Source:

200 to 250 VAC; 60 Hz, three-phase; available transformer taps are 200, 210, 220, 230, 240, 250 VAC; 50 Hz available on request

Permissible Line Voltage Variation:

±5% (each phase voltage variation; within 5% of the average of all three phases)

Filament Regulator:

±1% of optimum

OPERATING ENVIRONMENT

Operating Altitude:

7,500 ft (2,286 m) standard; optional to 10,000 ft (3,048 m) with modification kit

Ambient Temperature Range:

-20°C to +50°C (-4°F to +122°F)

MECHANICAL

Transmitter:

- 69" (175 cm) H
- 72" (183 cm) W
- 28" (71 cm) D

Weight:

1,962 lbs (890 kg) nominal

All specifications are subject to change without notice.

FM Type 816R-3B 25 kW FM Transmitter

Type 816R-3B

Continental's 816R-3B is a high performance, state-of-the-art transmitter that uses the Type 802A Exciter to deliver a crisp, clean signal.

The 816R-3B is solid-state except for one tube: a 4CX15000A power amplifier operating at Class C.

Standard features include remote control equipment and an automatic overload/recycle system. The transmitter is completely self-contained in one small cabinet, including harmonic filter.

SPECIFICATIONS

using 802A solid-state exciter

GENERAL

Rated Power Output:

816R-2B: 21.5 kW

816R-3B: 25 kW

816R-4B: 27.5 kW

Power Consumption:

816R-2B: 33 kW nominal

816R-3B: 40 kW nominal

816R-4B: 42 kW nominal

Frequency Range:

88 to 108 MHz, in 10 kHz steps

Frequency Control:

Phase-locked loop frequency synthesis from high stability master oscillator

Frequency Stability:

±250 Hz

Output Impedance:

50 ohms

Output Connector:

3/8" EIA flange

VSWR:

2:1, maximum

Modulation Type:

Direct carrier frequency modulation

Modulation Capability:

±150 kHz deviation

Modulation Indication:

Digital LED display shows true peak level of modulating signal in 5% increments with accuracy better than ±2%

Exciter:

Solid-state unit with variable output of 5 to 50 watts; self-contained harmonic filter

RF Harmonic Attenuation:

-80 dB, minimum

Power Supply Rectifiers:

Silicon

MONAURAL OPERATION

Audio Input Impedance:

600 ohms, balanced

Audio Input Return Loss:

30 dB or better

Audio Input Level:

+10 dBm (6.93 V peak-to-peak) at 600 ohms for ±75 kHz deviation

Audio Frequency Response:

±0.5 dB; flat, 25, 50 or 75 microsecond pre-emphasis, 20 Hz to 15 kHz

Total Harmonic Distortion:

0.08% maximum; 20 Hz to 15 kHz (Measured with spectrum analyzer)

Intermodulation Distortion:

0.08% or less, 60 Hz/7 kHz, 4:1 ratio

FM S/N Ratio (FM Noise):

75 dB minimum, below ±75 kHz deviation at 400 Hz, measured within a 20 Hz to 15 kHz bandwidth with 75 microsecond de-emphasis

Asynchronous AM S/N Ratio

(AM Noise):

55 dB RMS below carrier; reference: 100% AM modulation, full power, with 75 microsecond de-emphasis, no FM modulation

Synchronous AM S/N Ratio

(Incidental AM Noise):

50 dB below carrier; reference: 100% AM modulation, full power, with 75 microsecond de-emphasis, FM modulation ±75 kHz at 400 Hz

WIDEBAND OPERATION

Composite Inputs:

Balanced, unbalanced and test

Composite Input Impedance:

5,000 ohms, nominal

Composite Input Level:

1.25 V RMS (354 V peak-to-peak) for ±75 kHz deviation

Composite Amplitude Response:

±0.1 dB, 20 Hz to 100 kHz

Composite Total Harmonic Distortion:

0.08% maximum

Composite Intermodulation Distortion:

0.08% maximum; 60 Hz to 7 kHz, 4:1 ratio

Two SCA Inputs:

Balanced or unbalanced

SCA Input Impedance:

15,000 ohms, nominal

SCA Input Level:

1.25 V RMS for ±75 kHz deviation

SCA Amplitude Response:

±0.3 dB, 40 kHz to 100 kHz

STEREO OPERATION

Most stereo performance parameters are determined primarily by the stereo generator used. The following parameters are influenced by the RF system. These specifications assume that a state-of-the-art stereo generator is used.

Stereo Separation:

50 dB minimum; 50 Hz to 15 kHz (60 dB or better, 400 Hz to 7.5 kHz typical)

Total Harmonic Distortion:

0.08% maximum; 50 Hz to 15 kHz (Measured with spectrum analyzer)

Intermodulation Distortion:

0.08% maximum; 60 Hz to 7 kHz, 4:1 ratio

FM Noise:

-72 dB referenced to 400 Hz, 75 kHz deviation. Measured with 75 microsecond de-emphasis within a 20 Hz to 15 kHz bandwidth

Linear Crosstalk:

-55 dB

SCA OPERATION

Most SCA performance parameters are determined primarily by the SCA generator used. The following parameters are influenced by the RF system. These specifications assume that a state-of-the-art SCA generator is used.

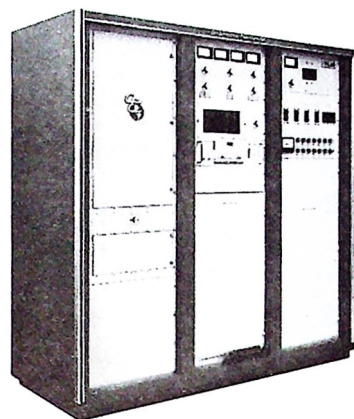

Crosstalk, SCA to Main and Stereo

(67 kHz and/or 92 kHz):

-60 dB, SCA deviation 5 kHz; main 75 microsecond de-emphasis

Crosstalk, Main and Stereo to SCA

(67 kHz and/or 92 kHz):

-50 dB, main and stereo 75 kHz deviation; SCA reference deviation, 5 kHz and 200 Hz modulation; SCA de-emphasis, 150 microsecond

Crosstalk, SCA to SCA

(67 kHz and/or 92 kHz):

-50 dB, SCA reference deviation; 5 kHz and 200 Hz modulation frequency, 150 microsecond de-emphasis

ELECTRICAL

Power Source:

200 to 250 VAC; 60 Hz, three-phase; available transformer taps are 200, 210, 220, 230, 240, 250 VAC; 50 Hz available on request

Permissible Line Voltage Variation:

±5% (each phase voltage variation; within 5% of the average of all three phases)

Filament Regulator:

±1% of optimum

OPERATING ENVIRONMENT

Operating Altitude:

7,500 ft (2,286 m) standard; optional to 10,000 ft (3,048 m) with modification kit

Ambient Temperature Range:

-20°C to +50°C (-4°F to +122°F)

MECHANICAL

Transmitter:

69" (175 cm) H

72" (183 cm) W

28" (71 cm) D

Weight:

1,962 lbs (890 kg) nominal

All specifications are subject to change without notice.

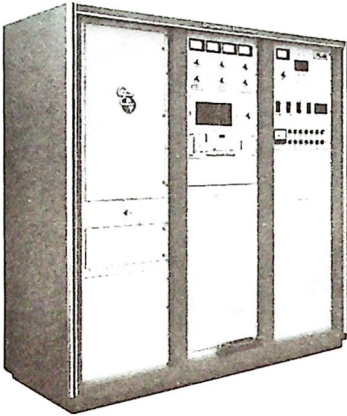

Type 816R-4B

Continental's 816R-4B is a high performance, state-of-the-art transmitter that uses the Type 802A Exciter to deliver a crisp, clean signal.

The 816R-4B is solid-state except for one tube: a 4CX15000A power amplifier operating at Class C.

Standard features include remote control equipment and an automatic overload/recycle system. The transmitter is completely self-contained in one small cabinet, including harmonic filter.

SPECIFICATIONS
using 802A solid-state exciter

GENERAL

Rated Power Output:

- 816R-2B: 21.5 kW
- 816R-3B: 25 kW
- 816R-4B: 27.5 kW

Power Consumption:

- 816R-2B: 33 kW nominal
- 816R-3B: 40 kW nominal
- 816R-4B: 42 kW nominal

Frequency Range:

88 to 108 MHz, in 10 kHz steps

Frequency Control:

Phase-locked loop frequency synthesis from high stability master oscillator

Frequency Stability:

±250 Hz

Output Impedance:

50 ohms

Output Connector:

3/8" EIA flange

VSWR:

2:1, maximum

Modulation Type:

Direct carrier frequency modulation

Modulation Capability:

±150 kHz deviation

Modulation Indication:

Digital LED display shows true peak level of modulating signal in 5% increments with accuracy better than ±2%

Exciter:

Solid-state unit with variable output of 5 to 50 watts; self-contained harmonic filter

RF Harmonic Attenuation:

-80 dB, minimum

Power Supply Rectifiers:

Silicon

MONAURAL OPERATION

Audio Input Impedance:

600 ohms, balanced

Audio Input Return Loss:

30 dB or better

Audio Input Level:

+ 10 dBm (6.93 V peak-to-peak) at 600 ohms for ±75 kHz deviation

Audio Frequency Response:

±0.5 dB; flat, 25, 50 or 75 microsecond pre-emphasis, 20 Hz to 15 kHz

Total Harmonic Distortion:

0.08% maximum; 20 Hz to 15 kHz (Measured with spectrum analyzer)

Intermodulation Distortion:

0.08% or less, 60 Hz/7 kHz, 4:1 ratio

FM S/N Ratio (FM Noise):

75 dB minimum, below ±75 kHz deviation at 400 Hz, measured within a 20 Hz to 15 kHz bandwidth with 75 microsecond de-emphasis

Asynchronous AM S/N Ratio (AM Noise):

55 dB RMS below carrier; reference: 100% AM modulation, full power, with 75 microsecond de-emphasis, no FM modulation

Synchronous AM S/N Ratio (Incidental AM Noise):

50 dB below carrier; reference: 100% AM modulation, full power, with 75 microsecond de-emphasis, FM modulation ±75 kHz at 400 Hz

WIDEBAND OPERATION

Composite Inputs:

Balanced, unbalanced and test

Composite Input Impedance:

5,000 ohms, nominal

Composite Input Level:

1.25 V RMS (3.54 V peak-to-peak) for ±75 kHz deviation

Composite Amplitude Response:

±0.1 dB, 20 Hz to 100 kHz

Composite Total Harmonic Distortion:

0.08% maximum

Composite Intermodulation Distortion:

0.08% maximum; 60 Hz to 7 kHz, 4:1 ratio

Two SCA Inputs:

Balanced or unbalanced

SCA Input Impedance:

15,000 ohms, nominal

SCA Input Level:

1.25 V RMS for ±75 kHz deviation

SCA Amplitude Response:

±0.3 dB, 40 kHz to 100 kHz

STEREO OPERATION

Most stereo performance parameters are determined primarily by the stereo generator used. The following parameters are influenced by the RF system. These specifications assume that a state-of-the-art stereo generator is used.

Stereo Separation:

50 dB minimum; 50 Hz to 15 kHz (60 dB or better, 400 Hz to 7.5 kHz typical)

Total Harmonic Distortion:

0.08% maximum; 50 Hz to 15 kHz (Measured with spectrum analyzer)

Intermodulation Distortion:

0.08% maximum; 60 Hz to 7 kHz, 4:1 ratio

FM Noise:

-72 dB referenced to 400 Hz, 75 kHz deviation. Measured with 75 microsecond de-emphasis within a 20 Hz to 15 kHz bandwidth

Linear Crosstalk:

-55 dB

SCA OPERATION

Most SCA performance parameters are determined primarily by the SCA generator used. The following parameters are influenced by the RF system. These specifications assume that a state-of-the-art SCA generator is used.

Crosstalk, SCA to Main and Stereo (67 kHz and/or 92 kHz):

-60 dB, SCA deviation 5 kHz; main 75 microsecond de-emphasis

Crosstalk, Main and Stereo to SCA (67 kHz and/or 92 kHz):

-50 dB, main and stereo 75 kHz deviation; SCA reference deviation, 5 kHz and 200 Hz modulation; SCA de-emphasis, 150 microsecond

Crosstalk, SCA to SCA (67 kHz and/or 92 kHz):

-50 dB, SCA reference deviation; 5 kHz and 200 Hz modulation frequency, 150 microsecond de-emphasis

ELECTRICAL

Power Source:

200 to 250 VAC; 60 Hz, three-phase; available transformer taps are 200, 210, 220, 230, 240, 250 VAC; 50 Hz available on request

Permissible Line Voltage Variation:

±5% (each phase voltage variation; within 5% of the average of all three phases)

Filament Regulator:

±1% of optimum

OPERATING ENVIRONMENT

Operating Altitude:

7,500 ft (2,286 m) standard; optional to 10,000 ft (3,048 m) with modification kit

Ambient Temperature Range:

-20°C to +50°C (-4°F to +122°F)

MECHANICAL

Transmitter:

- 69" (175 cm) H
- 72" (183 cm) W
- 28" (71 cm) D

Weight:

1,962 lbs (890 kg) nominal

All specifications are subject to change without notice.

FM Type 816R-5B 35 kW FM Transmitter

Type 816R-5B

Continental's 816R-5B is a high performance, state-of-the-art transmitter that uses the Type 802A Exciter to deliver a crisp, clean signal.

The transmitter is solid-state, except for one tube: a 9019/YC130 power amplifier operating at Class C.

IC logic is used for all control functions. A computer-like memory, powered by battery backup, restarts the transmitter after a power failure.

Standard features include remote control interface, overload/recycle system, filament voltage regulation, automatic RF power control, and SWR foldback.

The transmitter is completely self-contained in one cabinet, including harmonic filter, except for the plate transformer which may be located at any location up to 20 ft. away from the transmitter.

SPECIFICATIONS using 802A solid-state exciter

GENERAL

Rated Power Output:
35 kW

Power Consumption:
54 kW, nominal

Frequency Range:
88 to 108 MHz, in 10 kHz steps

Frequency Control:
Phase-locked loop frequency synthesis from high stability master oscillator

Frequency Stability:
±250 Hz

Output Impedance:
50 ohms

Output Connector:
3/4" EIA flange

VSWR:
2:1, maximum

Modulation Type:
Direct carrier frequency modulation

Modulation Capability:
±150 kHz deviation

Modulation Indication:
Digital LED display shows true peak level of modulated signal in 5% increments with accuracy better than ±2%

Exciter:
Solid-state unit with variable output of 5 to 50 watts; self-contained harmonic filter

RF Harmonic Attenuation:
-80 dB, minimum

Power Supply Rectifiers:
Silicon

MONAURAL OPERATION

Audio Input Impedance:
600 ohms, balanced

Audio Input Return Loss:
30 dB or better

Audio Input Level:
+ 10 dBm (6.93 V peak-to-peak) at 600 ohms for ±75 kHz deviation

Audio Frequency Response:
±0.5 dB; flat, 25, 50 or 75 microsecond pre-emphasis, 20 Hz to 15 kHz

Total Harmonic Distortion:

0.08% maximum; 20 Hz to 15 kHz
(Measured with spectrum analyzer)

Intermodulation Distortion:

0.08% or less, 60 Hz to 7 kHz, 4:1 ratio

FM S/N Ratio (FM Noise):

75 dB minimum, below ±75 kHz deviation at 400 Hz, measured within a 20 Hz to 15 kHz bandwidth with 75 microsecond de-emphasis

Asynchronous AM S/N Ratio

(AM Noise):

55 dB RMS below carrier; reference 100% AM modulation, full power, with 75 microsecond de-emphasis, no FM modulation

Synchronous AM S/N Ratio

(Incidental AM Noise):

50 dB below carrier; reference: 100% AM modulation, full power, with 75 microsecond de-emphasis, FM modulation ±75 kHz at 400 Hz

WIDEBAND OPERATION

Composite Inputs:

Balanced, unbalanced, test

Composite Input Impedance:

5,000 ohms, nominal

Composite Input Level:

1.25 V RMS (3.54 V peak-to-peak) for ±75 kHz deviation

Composite Amplitude Response:

±0.1 dB, 20 Hz to 100 kHz

Composite Total Harmonic Distortion:

0.08% maximum

Composite Intermodulation Distortion:

0.08% or less, 60 Hz to 7 kHz, 4:1 ratio

Two SCA Inputs:

Balanced or unbalanced

SCA Input Impedance:

15,000 ohms, nominal

SCA Input Level:

1.25 V RMS for ±75 kHz deviation

SCA Amplitude Response:

±0.3 dB, 40 kHz to 100 kHz

STEREO OPERATION

Most stereo performance parameters are determined primarily by the stereo generator used. The following parameters are influenced by the RF system, and assume that a state-of-the-art stereo generator is used.

Stereo Separation:

50 dB minimum; 50 Hz to 15 kHz (60 dB or better, 400 Hz to 7.5 kHz typical)

Total Harmonic Distortion:

0.08% maximum; 50 Hz to 15 kHz
(Measured with spectrum analyzer)

Intermodulation Distortion:

0.08% maximum; 60 Hz to 7 kHz, 4:1 ratio

FM Noise:

-72 dB minimum, below ±75 kHz deviation at 400 Hz, measured within a 20 Hz to 15 kHz bandwidth with 75 microsecond de-emphasis

Linear Crosstalk:

-55 dB

SCA OPERATION

Most SCA performance parameters are determined primarily by the SCA generator used. The following parameters are influenced by the RF system, and assume that a state-of-the-art SCA generator is used.

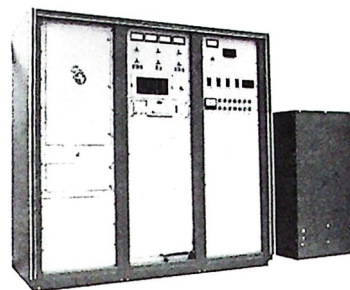

Crosstalk, SCA to Main and Stereo

(67 kHz and/or 92 kHz):

-60 dB, SCA deviation 5 kHz; main 75 microsecond de-emphasis

Crosstalk, Main and Stereo to SCA

(67 kHz and/or 92 kHz):

-50 dB, main and stereo 75 kHz deviation; SCA reference deviation, 5 kHz and 200 Hz modulation; SCA de-emphasis, 150 microsecond

Crosstalk, SCA to SCA

(67 kHz and/or 92 kHz):

-50 dB, SCA reference deviation; 5 kHz and 200 Hz modulation, 150 microsecond de-emphasis

ELECTRICAL

Power Source:

200 to 250 VAC; 60 Hz, three-phase; available transformer taps are 200, 210, 220, 230, 240, 250 VAC; 50 Hz available on request

Permissible Line Voltage Variation:

±5% (each phase voltage variation; within 5% of the average of all three phases)

Filament Regulator:

±1% of optimum

OPERATING ENVIRONMENT

Altitude:

7,500 ft (2,286 m) standard; optional to 10,000 ft (3,048 m) with modification kit

Ambient Temperature Range:

-20°C to +50°C (-4°F to +122°F)

Relative Humidity:

0 to 95%

MECHANICAL

Transmitter:

69" (175 cm) H
72" (183 cm) W
28" (71 cm) D

Weight:

1,657 lbs (752 kg) nominal

External Plate Transformer:

46" (117 cm) H
35" (89 cm) W
24" (61 cm) D

Weight:

901 lbs (409 kg) nominal

Note:

External plate transformer can be located up to 20 ft (6.10 m) away from the transmitter

All specifications are subject to change without notice.

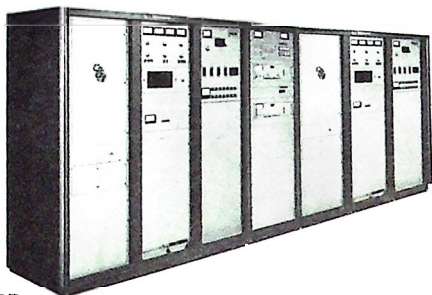

Type 817R-2B

Continental's 817R-2B is a high performance, state-of-the-art transmitter that uses the Type 802A Exciter to deliver a crisp, clean signal.

The 817R-2B is solid-state except for tubes in the power amplifier sections.

The 817R-2B consists of two Type 816R-2B 20 kW transmitters whose outputs are combined in a 90 degree hybrid to achieve 40 kW output. Through the optional use of coaxial switching, either transmitter can be put on the air independently.

Standard features include remote control interface, an automatic overload/recycle system and a self-contained harmonic filter.

Available options include Type 377C-1A automatic exciter control and Type 377D-1 automatic combiner control. Both options can be mounted in the 817R-2B control cabinet.

Combiners are described in the "Combiner Section" of this catalog.

SPECIFICATIONS

using 802A solid-state exciter

GENERAL

Rated Power Output:

817R-2B: 40 kW
817R-1B: 50 kW
817R-4B: 55 kW

Power Consumption:

817R-2B: 62 kW nominal
817R-1B: 80 kW nominal
817R-4B: 84 kW nominal

Frequency Range:

88 to 108 MHz, in 10 kHz steps

Frequency Control:

Phase-locked loop frequency synthesis from high stability master oscillator

Frequency Stability: ±250 Hz

Output Impedance: 50 ohms

Output Connector: 6-1/8" EIA flange

VSWR: 2:1, maximum

Modulation Type:

Direct carrier frequency modulation

Modulation Capability: ±150 kHz deviation

Modulation Indication:

Digital LED display shows true peak level of modulated signal in 5% increments with accuracy better than ±2%

Exciter:

Solid-state unit with variable output of 5 to 50 watts; self-contained harmonic filter

RF Harmonic Attenuation: -80 dB, minimum

Power Supply Rectifiers: Silicon

MONAURAL OPERATION

Audio Input Impedance:

600 ohms, balanced

Audio Input Return Loss:

30 dB or better

Audio Input Level:

+10 dBm (6.93 V peak-to-peak) at 600 ohms for ±75 kHz deviation

Audio Frequency Response:

±0.5 dB, flat, 25, 50 or 75 microsecond pre-emphasis, 20 Hz to 15 kHz

Total Harmonic Distortion:

0.08% maximum; 20 Hz to 15 kHz (Measured with spectrum analyzer)

Intermodulation Distortion:

0.08% or less, 60 Hz/7 kHz, 4:1 ratio

FM S/N Ratio (FM Noise):

75 dB minimum, below ±75 kHz deviation at 400 Hz, measured within a 20 Hz to 15 kHz bandwidth with 75 microsecond de-emphasis

Asynchronous AM S/N Ratio (AM Noise):

55 dB RMS below carrier; reference: 100% AM modulation, full power, with 75 microsecond de-emphasis, no FM modulation

Synchronous AM S/N Ratio (Incidental AM Noise):

50 dB below carrier; reference: 100% AM modulation, full power, with 75 microsecond de-emphasis, FM modulation ±75 kHz at 400 Hz

WIDEBAND OPERATION

Composite Inputs:

Balanced, unbalanced and test

Composite Input Impedance:

5,000 ohms, nominal

Composite Input Level:

1.25 V RMS (3.54 V peak-to-peak) for ±75 kHz deviation

Composite Amplitude Response:

±0.1 dB, 20 Hz to 100 kHz

Composite Total Harmonic Distortion:

0.08% maximum

Composite Intermodulation Distortion:

0.08% maximum; 60 Hz to 7 kHz, 4:1 ratio

Two SCA Inputs:

Balanced or unbalanced

SCA Input Impedance:

15,000 ohms, nominal

SCA Input Level:

1.25 V RMS for ±75 kHz deviation

SCA Amplitude Response:

±0.3 dB, 40 kHz to 100 kHz

STEREO OPERATION

Most stereo performance parameters are determined primarily by the stereo generator used. The following parameters are influenced by the RF system. These specifications assume

that a state-of-the-art stereo generator is used.

Stereo Separation:

50 dB minimum; 50 Hz to 15 kHz (60 dB or better, 400 Hz to 7.5 kHz typical)

Total Harmonic Distortion:

0.08% maximum; 50 Hz to 15 kHz (Measured with spectrum analyzer)

Intermodulation Distortion:

0.08% maximum; 60 Hz to 7 kHz, 4:1 ratio

FM Noise:

-72 dB referenced to 400 Hz, 75 kHz deviation. Measured with 75 microsecond de-emphasis within a 20 Hz to 15 kHz bandwidth

Linear Crosstalk: -55 dB

SCA OPERATION

Most SCA performance parameters are determined primarily by the SCA generator used. The following parameters are influenced by the RF system. These specifications assume that a state-of-the-art SCA generator is used.

Crosstalk, SCA to Main and Stereo (67 kHz and/or 92 kHz):

-60 dB, SCA deviation 5 kHz, main 75 microsecond de-emphasis

Crosstalk, Main and Stereo to SCA (67 kHz and/or 92 kHz):

-50 dB, main and stereo 75 kHz deviation; SCA reference deviation, 5 kHz and 200 Hz modulation; SCA de-emphasis, 150 microsecond

Crosstalk, SCA to SCA (67 kHz and/or 92 kHz):

-50 dB, SCA reference deviation 5 kHz and 200 Hz modulation frequency, 150 microsecond de-emphasis

ELECTRICAL

Power Source:

200 to 250 VAC; 60 Hz, three-phase; available transformer taps are 200, 210, 220, 230, 240, 250 VAC; 50 Hz available on request

Permissible Line Voltage Variation:

±5% (each phase voltage variation within 5% of the average of all three phases)

Filament Regulator:

±1% of optimum

OPERATING ENVIRONMENT

Altitude:

7,500 ft (2,286 m) standard; optional to 10,000 ft (3,048 m) with modification kit

Ambient Temperature Range:

-20°C to +50°C (-4°F to +122°F)

MECHANICAL

Transmitter:

69" (175 cm) H
159.8" (406 cm) W
28" (71 cm) D

Weight: 4,074 lbs. (1,836 kg) nominal

Combiner, 40 kW:

60" (152 cm) H
48" (122 cm) W
30" (76 cm) D

Weight: 790 lbs. nominal (358 kg)

Combiner, 50/55 kW:

73" (185 cm) H
68½" (174 cm) W
31" (79 cm) D

Weight: 1,130 lbs. (513 kg) nominal

All specifications are subject to change without notice.

FM Type 817R-1B 50 kW FM Transmitter

Type 817R-1B

Continental's 817R-1B is a high performance, state-of-the-art transmitter that uses the Type 802A Exciter to deliver a crisp, clean signal.

The 817R-1B is solid-state except for tubes in the power amplifier sections.

The 817R-1B consists of two Type 816R-3B 25 kW transmitters whose outputs are combined in a 90 degree hybrid to achieve 50 kW output. Through the optional use of coaxial switching, either transmitter can be put on the air independently.

Standard features include remote control interface, an automatic overload/recycle system and self-contained harmonic filter.

Available options include Type 377C-1A automatic exciter control and Type 377D-1 automatic combiner control. Both options can be mounted in the 817R-1B control cabinet.

Combiners are described in the "Combiner Section" of this catalog.

GENERAL

Rated Power Output:

817R-2B: 40 kW

817R-1B: 50 kW

817R-4B: 55 kW

Power Consumption:

817R-2B: 62 kW nominal

817R-1B: 80 kW nominal

817R-4B: 84 kW nominal

Frequency Range:

88 to 108 MHz, in 10 kHz steps

Frequency Control:

Phase-locked loop frequency synthesis from high stability master oscillator

Frequency Stability: ± 250 Hz

Output Impedance: 50 ohms

Output Connector: 6-1/8" EIA flange

VSWR: 2:1, maximum

Modulation Type:

Direct carrier frequency modulation

Modulation Capability: ± 150 kHz deviation

Modulation Indication:

Digital LED display shows true peak level of modulated signal in 5% increments with accuracy better than $\pm 2\%$

Exciter:

Solid-state unit with variable output of 5 to 50 watts; self-contained harmonic filter

RF Harmonic Attenuation: -80 dB, minimum

Power Supply Rectifiers: Silicon

MONAURAL OPERATION

Audio Input Impedance:

600 ohms, balanced

Audio Input Return Loss:

30 dB or better

Audio Input Level:

+10 dBm (6.93 V peak-to-peak) at 600 ohms for ± 75 kHz deviation

Audio Frequency Response:

± 0.5 dB; flat, 25, 50 or 75 microsecond pre-emphasis, 20 Hz to 15 kHz

Total Harmonic Distortion:

0.08% maximum; 20 Hz to 15 kHz (Measured with spectrum analyzer)

Intermodulation Distortion:

0.08% or less, 60 Hz/7 kHz, 4:1 ratio

FM S/N Ratio (FM Noise):

75 dB minimum, below ± 75 kHz

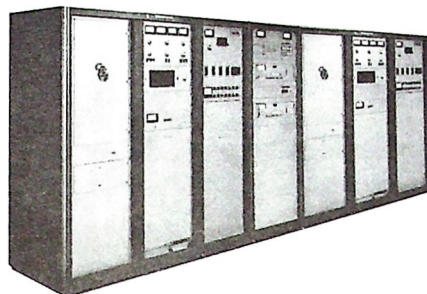

deviation at 400 Hz, measured within a 20 Hz to 15 kHz bandwidth with 75 microsecond de-emphasis

Asynchronous AM S/N Ratio

(AM Noise):

55 dB RMS below carrier; reference: 100% AM modulation, full power, with 75 microsecond de-emphasis, no FM modulation

Synchronous AM S/N Ratio

(Incidental AM Noise):

50 dB below carrier; reference: 100% AM modulation, full power, with 75 microsecond de-emphasis, FM modulation ± 75 kHz at 400 Hz

WIDEBAND OPERATION

Composite Inputs:

Balanced, unbalanced and test

Composite Input Impedance:

5,000 ohms, nominal

Composite Input Level:

1.25 V RMS (3.54 V peak-to-peak) for ± 75 kHz deviation

Composite Amplitude Response:

± 0.1 dB, 20 Hz to 100 kHz

Composite Total Harmonic Distortion:

0.08% maximum

Composite Intermodulation Distortion:

0.08% maximum; 60 Hz to 7 kHz, 4:1 ratio

Two SCA Inputs:

Balanced or unbalanced

SCA Input Impedance:

15,000 ohms, nominal

SCA Input Level:

1.25 V RMS for ± 75 kHz deviation

SCA Amplitude Response:

± 0.3 dB, 40 kHz to 100 kHz

STEREO OPERATION

Most stereo performance parameters are determined primarily by the stereo generator used. The following parameters are influenced by the RF system. These specifications assume that a state-of-the-art stereo generator is used.

Stereo Separation:

50 dB minimum; 50 Hz to 15 kHz (60 dB or better, 400 Hz to 7.5 kHz typical)

Total Harmonic Distortion:

0.08% maximum; 50 Hz to 15 kHz (Measured with spectrum analyzer)

Intermodulation Distortion:

0.08% maximum; 60 Hz to 7 kHz, 4:1 ratio

FM Noise:

-72 dB referenced to 400 Hz, 75 kHz deviation. Measured with 75 microsecond de-emphasis within a 20 Hz to 15 kHz bandwidth

Linear Crosstalk: -55 dB

SCA OPERATION

Most SCA performance parameters are determined primarily by the SCA generator used. The following parameters are influenced by the RF system. These specifications assume that a state-of-the-art SCA generator is used.

Crosstalk, SCA to Main and Stereo

(67 kHz and/or 92 kHz):

-60 dB, SCA deviation 5 kHz, main 75 microsecond de-emphasis

Crosstalk, Main and Stereo to SCA

(67 kHz and/or 92 kHz):

-50 dB, main and stereo 75 kHz deviation; SCA reference deviation, 5 kHz and 200 Hz modulation; SCA de-emphasis, 150 microsecond

Crosstalk, SCA to SCA

(67 kHz and/or 92 kHz):

-50 dB, SCA reference deviation 5 kHz and 200 Hz modulation frequency, 150 microsecond de-emphasis

ELECTRICAL

Power Source:

200 to 250 VAC; 60 Hz, three-phase; available transformer taps are 200, 210, 220, 230, 240, 250 VAC; 50 Hz available on request

Permissible Line Voltage Variation:

$\pm 5\%$ (each phase voltage variation within 5% of the average of all three phases)

Filament Regulator:

$\pm 1\%$ of optimum

OPERATING ENVIRONMENT

Altitude:

7,500 ft (2,286 m) standard; optional to 10,000 ft (3,048 m) with modification kit

Ambient Temperature Range:

-20°C to +50°C (-4°F to +122°F)

MECHANICAL

Transmitter:

69" (175 cm) H

159.8" (406 cm) W

28" (71 cm) D

Weight: 4,074 lbs. (1,836 kg) nominal

Combiner, 40 kW:

60" (152 cm) H

48" (122 cm) W

30" (76 cm) D

Weight: 790 lbs. nominal (358 kg)

Combiner, 50/55 kW:

73" (185 cm) H

68½" (174 cm) W

31" (79 cm) D

Weight: 1,130 lbs. (513 kg) nominal

All specifications are subject to change without notice.

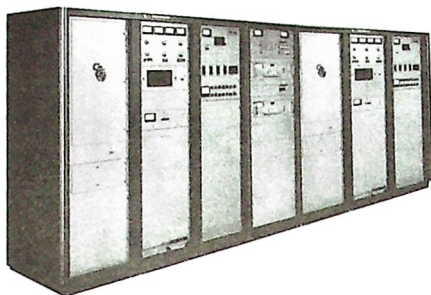

Type 817R-4B

Continental's 817R-4B is a high performance, state-of-the-art transmitter that uses the Type 802A Exciter to deliver a crisp, clean signal.

The 817R-4B is solid-state except for tubes in the power amplifier sections.

The 817R-4B consists of two Type 816R-4B 27.5 kW transmitters whose outputs are combined in a 90 degree hybrid to achieve 55 kW output. Through the optional use of coaxial switching, either transmitter can be put on the air independently.

Standard features include remote control interface, an automatic overload/recycle system and self-contained harmonic filter.

Available options include Type 377C-1A automatic exciter control and Type 377D-1 automatic combiner control. Both options can be mounted in the 817R-4B control cabinet.

Combiners are described in the "Combiner Section" of this catalog.

SPECIFICATIONS

using 802A solid-state exciter

GENERAL

Rated Power Output:

- 817R-2B: 40 kW
- 817R-1B: 50 kW
- 817R-4B: 55 kW

Power Consumption:

- 817R-2B: 62 kW nominal
- 817R-1B: 80 kW nominal
- 817R-4B: 84 kW nominal

Frequency Range:

- 88 to 108 MHz, in 10 kHz steps

Frequency Control:

- Phase-locked loop frequency synthesis from high stability master oscillator

Frequency Stability: ± 250 Hz

Output Impedance: 50 ohms

Output Connector: 6-1/8" EIA flange

VSWR: 2:1, maximum

Modulation Type:

- Direct carrier frequency modulation

Modulation Capability: ± 150 kHz deviation

Modulation Indication:

- Digital LED display shows true peak level of modulated signal in 5% increments with accuracy better than ± 2%

Exciter:

- Solid-state unit with variable output of 5 to 50 watts; self-contained harmonic filter

RF Harmonic Attenuation: - 80 dB, minimum

Power Supply Rectifiers: Silicon

MONAURAL OPERATION

Audio Input Impedance:

- 600 ohms, balanced

Audio Input Return Loss:

- 30 dB or better

Audio Input Level:

- + 10 dBm (6.93 V peak-to-peak) at 600 ohms for ± 75 kHz deviation

Audio Frequency Response:

- ± 0.5 dB; flat, 25, 50 or 75 microsecond pre-emphasis, 20 Hz to 15 kHz

Total Harmonic Distortion:

- 0.08% maximum; 20 Hz to 15 kHz (Measured with spectrum analyzer)

Intermodulation Distortion:

- 0.08% or less, 60 Hz/7 kHz, 4:1 ratio

FM S/N Ratio (FM Noise):

- 75 dB minimum, below ± 75 kHz deviation at 400 Hz, measured within a 20 Hz to 15 kHz bandwidth with 75 microsecond de-emphasis

Asynchronous AM S/N Ratio

(AM Noise):

- 55 dB RMS below carrier; reference: 100% AM modulation, full power, with 75 microsecond de-emphasis, no FM modulation

Synchronous AM S/N Ratio

(Incidental AM Noise):

- 50 dB below carrier; reference: 100% AM modulation, full power, with 75 microsecond de-emphasis, FM modulation ± 75 kHz at 400 Hz

WIDEBAND OPERATION

Composite Inputs:

- Balanced, unbalanced and test

Composite Input Impedance:

- 5,000 ohms, nominal

Composite Input Level:

- 1.25 V RMS (3.54 V peak-to-peak) for ± 75 kHz deviation

Composite Amplitude Response:

- ± 0.1 dB, 20 Hz to 100 kHz

Composite Total Harmonic Distortion:

- 0.08% maximum

Composite Intermodulation Distortion:

- 0.08% maximum; 60 Hz to 7 kHz, 4:1 ratio

Two SCA Inputs:

- Balanced or unbalanced

SCA Input Impedance:

- 15,000 ohms, nominal

SCA Input Level:

- 1.25 V RMS for ± 7.5 kHz deviation

SCA Amplitude Response:

- ± 0.3 dB, 40 kHz to 100 kHz

STEREO OPERATION

Most stereo performance parameters are determined primarily by the stereo generator used. The following parameters are influenced by the RF system. These specifications assume

that a state-of-the-art stereo generator is used.

Stereo Separation:

- 50 dB minimum; 50 Hz to 15 kHz (60 dB or better, 400 Hz to 7.5 kHz typical)

Total Harmonic Distortion:

- 0.08% maximum; 50 Hz to 15 kHz (Measured with spectrum analyzer)

Intermodulation Distortion:

- 0.08% maximum; 60 Hz to 7 kHz, 4:1 ratio

FM Noise:

- 72 dB referenced to 400 Hz, 75 kHz deviation. Measured with 75 microsecond de-emphasis within a 20 Hz to 15 kHz bandwidth

Linear Crosstalk: -55 dB

SCA OPERATION

Most SCA performance parameters are determined primarily by the SCA generator used. The following parameters are influenced by the RF system. These specifications assume that a state-of-the-art SCA generator is used.

Crosstalk, SCA to Main and Stereo

(67 kHz and/or 92 kHz):

- 60 dB, SCA deviation 5 kHz, main 75 microsecond de-emphasis

Crosstalk, Main and Stereo to SCA

(67 kHz and/or 92 kHz):

- 50 dB, main and stereo 75 kHz deviation; SCA reference deviation, 5 kHz and 200 Hz modulation; SCA de-emphasis, 150 microsecond

Crosstalk, SCA to SCA

(67 kHz and/or 92 kHz):

- 50 dB, SCA reference deviation 5 kHz and 200 Hz modulation frequency, 150 microsecond de-emphasis

ELECTRICAL

Power Source:

- 200 to 250 VAC; 60 Hz, three-phase; available transformer taps are 200, 210, 220, 230, 240, 250 VAC; 50 Hz available on request

Permissible Line Voltage Variation:

- ± 5% (each phase voltage variation within 5% of the average of all three phases)

Filament Regulator:

- ± 1% of optimum

OPERATING ENVIRONMENT

Altitude:

- 7,500 ft (2,286 m) standard; optional to 10,000 ft (3,048 m) with modification kit

Ambient Temperature Range:

- 20°C to +50°C (-4°F to +122°F)

MECHANICAL

Transmitter:

- 69" (175 cm) H
- 159.8" (406 cm) W
- 28" (71 cm) D

- Weight: 4,074 lbs. (1,836 kg) nominal

Combiner, 40 kW:

- 60" (152 cm) H
- 48" (122 cm) W
- 30" (76 cm) D

- Weight: 790 lbs. nominal (358 kg)

Combiner, 50/55 kW:

- 73" (185 cm) H
- 68 1/2" (174 cm) W
- 31" (79 cm) D

- Weight: 1,130 lbs. (513 kg) nominal

All specifications are subject to change without notice.

FM Type 817A 60 kW FM Transmitter

Type 817A

Continental's 817A is a high performance, state-of-the-art transmitter that uses the Type 802A Exciter to deliver a crisp, clean signal.

The transmitter is solid-state except for the single 4CX40,000G tube in the final amplifier. IC logic is used for all control functions. A battery supported digital circuit restarts the transmitter after a power failure.

Standard features include remote control interface and digital display via 8085 micro-processor system. The transmitter is completely self-contained including harmonic filter.

SPECIFICATIONS using 802A Exciter

GENERAL

Rated Power Output:

817A: 30, 40, 50, 60 kW

Power Consumption:

817A: 53, 65.6, 80.8, 94.4 kW nominal

Frequency Range:

88 to 108 MHz, in 10 kHz steps

Frequency Control:

Phase Locked Loop Frequency Synthesis from high stability master oscillator

Frequency Stability:

± 250 Hz

Output Impedance:

50 ohms

Output Connector:

6 1/2" EIA Flange

VSWR:

2:1, max.

Modulation Type:

Direct carrier frequency modulation

Modulation Capability:

± 150 kHz deviation

Modulation Indication:

Digital LED display shows true peak level of modulated signal in 5% increments with accuracy better than ± 2%

Exciter:

Solid-state unit with variable output of 5 to 50 watts, and self-contained harmonic filter

RF Harmonic Attenuation:

- 80 dB, min.

Power Supply Rectifiers:

Silicon

MONAURAL OPERATION

Audio Input Impedance:

600 ohms, balanced

Audio Input Return Loss:

30 dB or better

Audio Input Level:

+ 10 dBm (6.93 volts peak-to-peak) @ 600 ohms for ± 75 kHz deviation

Audio Frequency Response:

± 0.5 dB; flat, 25, 50 or 75 microsecond pre-emphasis, 20 Hz to 15 kHz

Total Harmonic Distortion:

0.2% max.; 20 Hz to 15 kHz (measured with Spectrum Analyzer.)

Intermodulation Distortion:

0.1% or less, 60 Hz/7 kHz 4:1 ratio

FM S/N Ratio (FM Noise):

72 dB min. below ± 75 kHz deviation @ 400 Hz, measured within a 20 Hz to 15 kHz bandwidth with 75 microsecond de-emphasis

Asynchronous AM S/N Ratio

(AM Noise):

55 dB RMS below carrier; reference: 100% AM modulation, full power @ 400 Hz with 75 microsecond de-emphasis, no FM modulation

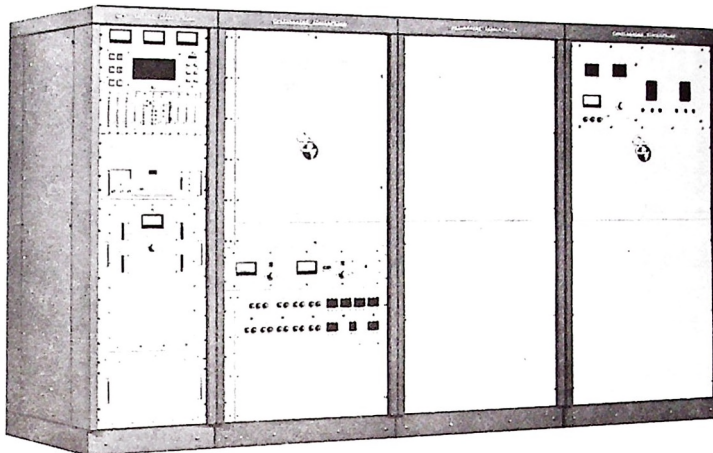

Synchronous AM S/N Ratio

(Incidental AM Noise):

40 dB below carrier; reference: 100% AM modulation, full power @ 400 Hz with 75 microsecond de-emphasis, FM modulation ± 75 kHz @ 400 Hz

WIDEBAND OPERATION

Composite Inputs:

Balanced, unbalanced and test

Composite Input Impedance:

5,000 ohms, nominal

Composite Input Level:

1.25 volts RMS (3.54 volts peak-to-peak) for ± 75 kHz deviation

Composite Amplitude Response:

± 0.1 dB, 20 Hz to 100 kHz

Composite Total Harmonic Distortion:

0.2% max.

Composite Intermodulation Distortion:

0.08% or less, 60 Hz/7 kHz 4:1 ratio

Two SCA Inputs:

Balanced or unbalanced

SCA Input Impedance:

50,000 ohms, nominal

SCA Input Level:

1.25 volts RMS for ± 7.5 kHz deviation

SCA Amplitude Response:

± 0.3 dB, 40 kHz to 100 kHz

STEREO OPERATION

Most Stereo performance parameters are determined primarily by the Stereo Generator used. The following parameters are influenced by the RF system. These specifications assume that a "State-of-the-Art" Stereo Generator is used.

Stereo Separation:

50 dB min.; 40 Hz to 15 kHz.

Total Harmonic Distortion:

0.1% max.; 40 Hz to 15 kHz (Measured with Spectrum Analyzer.)

Intermodulation Distortion:

0.08% max.; 60 Hz/7 kHz, 4:1 ratio

FM Noise:

- 72 dB referenced to 400 Hz, 75 kHz deviation. Measured with 75 microsecond de-emphasis within a 20 Hz to 15 kHz bandwidth.

Linear Crosstalk:

- 55 dB

SCA OPERATION

Most SCA performance parameters are determined primarily by the SCA generator used. The following parameters are influenced by the RF System. These specifications assume that a "State-of-the-Art" SCA Generator is used.

Crosstalk, SCA to Main and Stereo (67 kHz and/or 92 kHz):

- 60 dB, SCA deviation 5 kHz, Main 75 microsecond de-emphasis

Crosstalk, Main and Stereo to SCA (67 kHz or 92 kHz):

- 47 dB, Main and Stereo 75 kHz deviation; SCA reference deviation, 5 kHz and 200 Hz modulation; SCA de-emphasis, 150 microsecond

Crosstalk SCA to SCA

(67 kHz and 92 kHz):

- 50 dB, SCA reference deviation 5 kHz and 200 Hz modulation frequency; de-emphasis, 150 microsecond

ELECTRICAL

Power Source:

200 to 250 volts ac; 60 Hz, three phase; available transformer taps are 200, 210, 220, 230, 240, 250 volts ac; 50 Hz available on request.

Permissible Line Voltage Variation:

± 5% (each phase voltage variation; within 5% of the average of all three phases).

Filament regulator:

± 1% of optimum

OPERATING ENVIRONMENT

Altitude Range:

0 to 7,500 ft. (2286 m) standard; optional to 10,000 ft. (3048 m) with modification kit

Ambient Temperature Range:

- 20°C to + 50°C (- 4°F to + 122°F)

Relative Humidity:

0 to 95%

MECHANICAL

Size, as shown: 72" (175.3 cm) H, 128" (200.6 cm) W, 40" (86.4 cm) D

Weight: 4074 lb (2130 kg) nominal

All specifications are subject to change without notice.

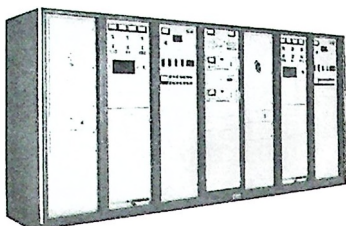

Type 817R-5B

Continental's 817R-5B is a high performance, state-of-the-art transmitter that uses the Type 802A Exciter to deliver a crisp, clean signal.

The 817R-5B is solid-state except for tubes in the power amplifier sections.

The 817R-5B consists of two Type 816R-5B 35 kW transmitters whose outputs are combined in a 90 degree hybrid to achieve 70 kW output. Through the optional use of coaxial switching, either transmitter can be put on the air independently.

Standard features include remote control interface, an automatic overload/recycle system and self-contained harmonic filter.

Available options include Type 377C-1A automatic exciter control and Type 377D-1 automatic combiner control. Both options can be mounted in the 817R-5B control cabinet.

Combiners are described in the "Combiner Section" of this catalog.

SPECIFICATIONS using 802A solid-state exciter

GENERAL

Rated Power Output:
70 kW

Power Consumption:
108 kW, nominal

Frequency Range:
88 to 108 MHz, in 10 kHz steps

Frequency Control:
Phase-locked loop frequency synthesis from high stability master oscillator

Frequency Stability:
±250 Hz

Output Impedance:
50 ohms

Output Connector:
6 $\frac{1}{8}$ " EIA flange

VSWR:
2:1, maximum

Modulation Type:
Direct carrier frequency modulation

Modulation Capability:
±150 kHz deviation

Modulation Indication:
Digital LED display shows true peak level of modulated signal in 5% increments with accuracy better than ±2%

Exciter:
Solid-state unit with variable output of 5 to 50 watts; self-contained harmonic filter

RF Harmonic Attenuation:
-80 dB, minimum

Power Supply Rectifiers:
Silicon

MONAURAL OPERATION

Audio Input Impedance:

600 ohms, balanced

Audio Input Return Loss:

30 dB or better

Audio Input Level:

+10 dBm (6.93 V peak-to-peak) at 600 ohms for ±75 kHz deviation

Audio Frequency Response:

±0.5 dB, flat, 25, 50 or 75 microsecond pre-emphasis, 20 Hz to 15 kHz

Total Harmonic Distortion:

0.08% maximum; 20 Hz to 15 kHz (Measured with spectrum analyzer)

Intermodulation Distortion:

0.08% or less, 60 Hz to 7 kHz, 4:1 ratio

FM S/N Ratio (FM Noise):

75 dB minimum, below ±75 kHz deviation at 400 Hz, measured within a 20 Hz to 15 kHz bandwidth with 75 microsecond de-emphasis

Asynchronous AM S/N Ratio (AM Noise):

55 dB RMS below carrier; reference: 100% AM modulation, full power, with 75 microsecond de-emphasis, no FM modulation

Synchronous AM S/N Ratio (Incidental AM Noise):

50 dB below carrier; reference: 100% AM modulation, full power, with 75 microsecond de-emphasis, FM modulation ±75 kHz at 400 Hz

WIDEBAND OPERATION

Composite Inputs:

Balanced, unbalanced, test

Composite Input Impedance:

5,000 ohms, nominal

Composite Input Level:

1.25 V RMS (3.54 V peak-to-peak) for ±75 kHz deviation

Composite Amplitude Response:

±0.1 dB, 20 Hz to 100 kHz

Composite Total Harmonic Distortion:

0.08% maximum

Composite Intermodulation Distortion:

0.08% or less, 60 Hz to 7 kHz, 4:1 ratio

Two SCA Inputs:

Balanced or unbalanced

SCA Input Impedance:

15,000 ohms, nominal

SCA Input Level:

1.25 V RMS for ±75 kHz deviation

SCA Amplitude Response:

±0.3 dB, 40 kHz to 100 kHz

STEREO OPERATION

Most stereo performance parameters are determined primarily by the stereo generator used. The following specifications are influenced by the RF system and assume that a state-of-the-art stereo generator is used.

Stereo Separation:

50 dB minimum; 50 Hz to 15 kHz (60 dB or better, 400 Hz to 7.5 kHz typical)

Total Harmonic Distortion:

0.08% maximum; 50 Hz to 15 kHz (Measured with spectrum analyzer)

Intermodulation Distortion:

0.08% maximum; 60 Hz to 7 kHz; 4:1 ratio

FM Noise

-72 dB minimum, below ±75 kHz deviation at 400 Hz, measured within a 20 Hz to 15 kHz bandwidth with 75 microsecond de-emphasis

Linear Crosstalk:

-55 dB

SCA OPERATION

Most SCA performance parameters are determined primarily by the SCA generator used. The following specifications are influenced by the RF system and assume that a state-of-the-art SCA generator is used.

Crosstalk, SCA to Main and Stereo

(67 kHz and/or 92 kHz):

-60 dB, SCA deviation 5 kHz; main 75 microsecond de-emphasis

Crosstalk, Main and Stereo to SCA

(67 kHz and/or 92 kHz):

-50 dB, main and stereo 75 kHz deviation; SCA reference deviation, 5 kHz and 200 Hz modulation; SCA de-emphasis, 150 microsecond

Crosstalk, SCA to SCA

(67 kHz and/or 92 kHz):

-50 dB, SCA reference deviation; 5 kHz and 200 Hz modulation, 150 microsecond de-emphasis

ELECTRICAL

Power Source:

200 to 250 VAC; 60 Hz, three-phase; available transformer taps are 200, 210, 220, 230, 240, 250 VAC; 50 Hz available on request

Permissible Line Voltage Variation:

±5% (each phase voltage variation; within 5% of the average of all three phases)

Filament Regulator:

±1% of optimum

OPERATING ENVIRONMENT

Altitude:

7,500 ft (2,286 m) standard; optional to 10,000 ft (3,048 m) with modification kit

Ambient Temperature Range:

-20°C to +50°C (-4°F to +122°F)

Relative Humidity:

0 to 95%

MECHANICAL

Transmitter:

69" (175 cm) H
159.8" (406 cm) W
28" (71 cm) D

Weight:

3,314 lbs (1,503 kg) nominal

External Plate Transformer:

46" (117 cm) H
35" (89 cm) W
24" (61 cm) D (each)

Weight:

901 lbs (409 kg) nominal (each)

Note:

The two external plate transformers can be located up to 20 ft (6.10 m) away from the transmitter

Combiner, 70 kW:

63" (185 cm) H
78 $\frac{1}{2}$ " (174 cm) W
31" (79 cm) D

Weight:

1,130 lbs (513 kg) nominal

All specifications are subject to change without notice.

**Continental's Customer Service . . .
*The Industry's Best!***

Call Anytime, Day Or Night.

**Main Offices:
(214) 381-7161**

**Parts:
(214) 388-3737**

**Engineering Service:
(214) 388-5800**

Telex: 73-398

FAX: (214) 381-4949

varian 

continental electronics division

4212 South Buckner Blvd., PO Box 270879
Dallas, Texas 75227 Ph: (214) 381-7161



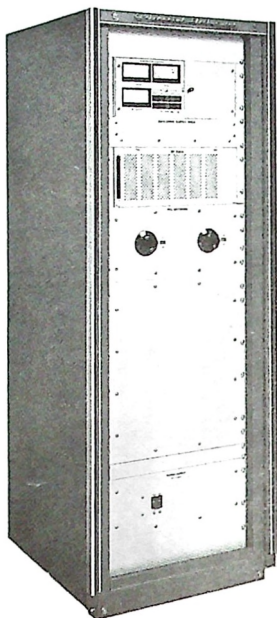

Top Performer with Proven Design

Continental's XL-301 1 kW AM solid-state transmitter offers broadcasters excellent, reliable audio performance in a modular, compact package. It is a result of our dedication to improve the performance and efficiency of AM transmitters.

The exciter, transmitter control and power amplifiers, are mounted on plug-in modules for ease of handling and maintenance.

Each MOSFET module employs on-board protection to prevent device failure from high temperature, overvoltage or overcurrent conditions.

In addition to the on-board power amplifier protection there is an overall VSWR sensing circuit.

The use of broadband and bandpass circuits combined with state-of-the-art integrated circuit technology enables the XL-301 to handle sophisticated audio processing.

Advanced circuit design allows simplified stereo interface.

Modular design simplifies transmitter spares requirements while making it easy to handle routine maintenance.

SPECIFICATIONS

GENERAL

RF Power Output:

1 kW, nominal;
1.1 kW, maximum

Power Consumption:

2.6 kW at 1 kW, 100% modulation

RF Power Reduction:

Three power levels standard; lowest available level is 10 watts

RF Frequency Range:

535 kHz to 1,705 kHz

PA Active Device:

MOSFET

Internal PA Protection:

Withstands short circuits at any point in output

Carrier Stability:

±5 Hz

Stereo interface:

Standard

Output Impedance:

50 ohms, unbalanced

VSWR:

1.2:1, maximum, full modulation;
1.5:1, maximum, full power at carrier

Output Connector:

L/C or protected terminal or type "N"

Carrier Shift:

2% maximum, (0.5% typical), at 100% modulation

Harmonics:

Meets CCIR & FCC regulations

Spurious Emissions:

Meets CCIR & FCC regulations

Audio Frequency Response:

±1 dB; 20 Hz to 12 kHz or better at 95% modulation, 1,000 Hz reference

Audio Frequency Harmonic Distortion:

Less than 1.5% at 95% modulation, 1 kW, 20 Hz to 12 kHz

Noise Below 100% Modulation:

Better than -60 dB, unweighted

Positive Peak Capability:

125% at 1,100 W output

Incidental Phase Modulation:

Less than 0.035 radians average; 95% modulation at 1 kHz

Audio Input:

-10 dBm to +10 dBm active, balanced, 150/600 ohms

Cooling:

Low velocity air

ELECTRICAL

Power Source:

180 to 250 VAC; 50/60 Hz, single phase; 3.8 KVA at 1 kW, 100% modulation

AC Source Tolerance:

-10% to +10% voltage for 70 VDC at 1 kW, ±5% frequency

OPERATING ENVIRONMENT

Altitude:

13,000 ft. (3,963 m)

Ambient Temperature Range:

0°C to 50°C (32°F to 122°F);
2°C/305 m (35.6°F/1,000 ft.) derating

Relative Humidity:

0 to 95%

MECHANICAL

Transmitter:

69" (175 cm) H
22" (56 cm) W
26" (66 cm) D

Weight:

560 lbs. (254kg)

Remote Control Interface:

Standard

Computer Control:

Optional; signal conditioning and interface provided

Front Panel Meters:

Three Analog

All specifications are subject to change without notice.

AM-MW Type 315R-1 5 kW AM Transmitter

Type 315R-1

Continental's 315R-1 offers broadcasters state-of-the-art performance, cost-effective operation and easy maintainability.

The transmitter cabinet opens for excellent accessibility. Modular circuit boards with extender cards and LED status indicators on major circuits and relays help to simplify maintenance. One tube type is used for both final PA and switchtube applications. The bottom line is a smooth, easily maintained, day-to-day operation.

Continental's 315R-1 transmitters achieve a final PA efficiency approaching 90% using the third harmonic injection technique of the proven Tyler-type. Combined with the high efficiency SwitchMod technique, overall efficiency exceeds 55%.

SwitchMod System

The dc coupled series switching modulator, combined with the stability of the proven 12 phase power supply, the built-in Instantaneous Peak Limiter (IPL) and the Automatic Modulation Control circuits, achieves dramatically improved AM audio performance in the areas of low frequency response, IM distortion and overall modulation density. IPL front panel adjustments set both positive and negative limits of modulation.

Overmodulation due to powerline variations or audio peaks is effectively prevented.

AM Stereo

Continental's Type 315R-1 is compatible with any AM Stereo Exciter approved by the FCC.

12-Phase Power Supply

The 12-phase power supply uses an Extended-Delta power transformer and two three-phase, full-wave rectifiers to develop high voltage dc with a 720 Hertz ripple frequency. Because of the high ripple frequency the absence of filter inductors and large capacitors help reduce the size of the transmitter while at the same time eliminating several expensive and failure-prone components. Inductors, which formerly caused resonances, are eliminated. Power supply sag and bounce are no longer a problem.

SPECIFICATIONS

ELECTRICAL

Frequency Range:

540-1,600 kHz

RF Output Power:

500-5,500 W

Output Impedance:

50 ohms nominal
(others available on request)

Output Fitting:

1-5/8" EIA male flange standard 7/8" EIA flange or stud output also available

Harmonic and Spurious:

Complies with FCC and CCIR regulations

Carrier Amplitude Regulation:

2% maximum, adjustable to 0

Frequency Stability:

±5 Hz (0 to 50°C); ±20 Hz (-20°C to 50°C)

Power Requirements:

200-250 VAC three-phase 3 or 4 wire, wye or closed delta. 50 Hz, 385-435 VAC available on request

Power Consumption:

130 KVA at 95% PF for 5,000 watts, 95% sine wave modulation

Overall Efficiency:

Better than 57% at 5,000 watts, 95% sine wave modulation

Frequency Response:

±1 dB, 20-10,000 Hz at 95% modulation, 5,000 watts output

Total Harmonic Distortion:

Less than 2% 20-10,000 Hz at 95% modulation, 5,000 watts output

Noise:

Better than -60 dB reference 400 Hz, for 100% modulation at 5,000 watts output

Audio Input:

+10 dBm ± 2 dB 600/150 ohms for 100% modulation

Modulation Capability:

-100%, +125% standard

GENERAL

Transmitter:

69" (176 cm) H
34¾" (88 cm) W
33¾" (85 cm) D
7.9 sq. ft (:75 sq. m)

Weight:

1,050 lbs (476 kg)

Tubes:

3CX3000F7 (2)

Air Flow Requirement:

500 CFM

Relative Humidity:

0 to 95%

Ambient Temperature Range:

To 0°C to +50°C (meets FCC requirements to -20°C)

Altitude:

7,500 ft (2,280 m)

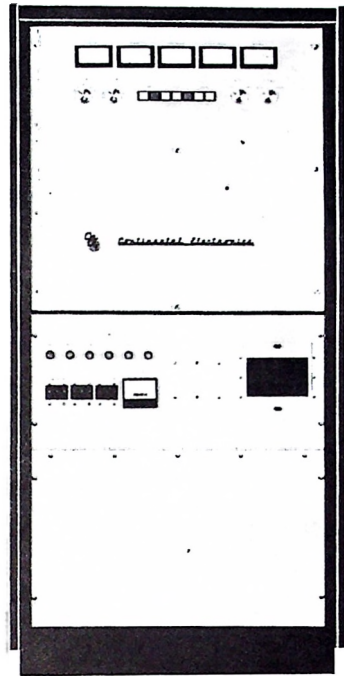

All specifications are subject to change without notice.

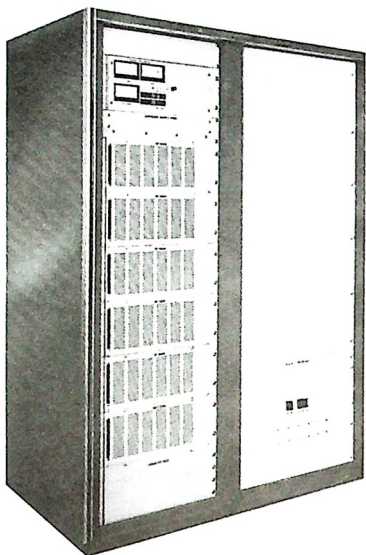

Top Performer

Continental's XL-310, 10 kW AM solid state transmitter offers broadcasters excellent, reliable performance in a modular, compact package, with improved efficiency.

The exciter, transmitter control and power amplifiers, are mounted on plug-in modules for ease of handling and maintenance.

Each MOSFET module employs on-board protection to prevent device failure from high temperature, overvoltage or overcurrent conditions.

In addition to the on-board power amplifier protection there is an overall VSWR sensing circuit.

The use of broadband and bandpass circuits combined with state-of-the-art integrated circuit technology enables the XL-310 to handle advanced audio processing.

Solid State Design

The XL-310 uses today's solid-state workhorse, the power FET transistor. The power FET is now the device of preference where high power, fast switching and rugged performance is required.

Load Fluctuations:

Deviations in load are corrected by front panel tuning and loading controls.

SPECIFICATIONS

GENERAL

RF Power Output:

10 kW nominal

Calculated Power Consumption:

17 kW at 10 kW 100% modulation

Typical Efficiency:

75% or better

RF Power Reduction:

Three power levels standard:
lowest available level is 100 watts

RF Frequency Range:

535 kHz to 1705 kHz

PA Active Device:

MOSFET

Internal PA Protection:

Withstands short circuits at any point in output

Carrier Stability:

±5 Hz

Stereo Interface:

Standard

Output Impedance:

50 Ohms, unbalanced

VSWR:

1.2:1, maximum, full modulation;
1.5:1, maximum, full power at carrier

Output Connector:

1-5/8 EIA Flange

Carrier Shift:

2% maximum, (0.5% typical),
at 100% modulation

Harmonics:

Meets CCIR & FCC regulations

Spurious Emissions:

Meets CCIR & FCC regulations

Audio Frequency Response:

±1 dB; 20 Hz to 12 kHz or better
at 95% modulation, 1,000 Hz reference

Audio Frequency Harmonic Distortion:

Less than 1.5% at 95% modulation,
10 kW, 20 Hz to 12 kHz

Noise Below 100% Modulation:

Better than -60 dB, unweighted

Positive Peak Capability:

125% at 10 kW output

Incidental Phase Modulation:

Less than 0.035 radians average;
95% modulation at 1 kHz

Audio Input:

-10 dBm to +10 dBm active,
balanced, 150/600 ohms

Cooling:

Low velocity air

ELECTRICAL

Power Source

180 to 250 VAC: 50/60 Hz, 3 Phase

AC Source Tolerance:

-10% to +10% voltage for 70 VDC
at 10 kW, ± 5% frequency

OPERATING ENVIRONMENT

Altitude:

13,000 ft. (3,963 m)

Ambient Temperature Range:

0°C to 50°C (32°F to 122°F)

2°C/305m (3.56°F/1,000 ft.) derating

Relative Humidity:

0 to 95%

MECHANICAL

Transmitter:

69" (175 cm) H

46" (117 cm) W

26" (66 cm) D

Export Shipping Volume:

48 Cubic Feet

Weight:

500 lbs (227 kg)

Export Shipping Weight:

700 lbs (318 kg)

Remote Control Interface:

Standard

Front Panel Meters:

Three Analog

All specifications are subject to change
without notice.

Preliminary

AM-MW Type 317C-3 50 kW AM Transmitter

Type 317C-3

Continental's 317C-3 is a 50 kW AM broadcast transmitter that meets today's programming demands. Its field-proven, cost effective design offers excellent performance with high overall efficiency, increased reliability and easy maintainability.

The 317C-3 replaces its predecessor, the 317C-2, and delivers superb audio quality and faithfully reproduces the most sophisticated audio processing. The solid-state driver, which replaces the 4-400C driver tube, further improves Continental's transmitter quality.

Continental's first 317C transmitter installation was a result of extensive research and analysis of transmitter circuit and modulation techniques.

Our early investigations included plate out-phasing (Ampliphase), screen grid, control grid, series anode, Cathanode and Doherty modulation systems. Later on, pulse width and pulse duration modulation were studied.

Out of this research came Continental's patented* screen-impedance modulation technique. Our application of this technology to the final amplifier tubes in the Doherty system achieved high performance combined with high efficiency.

Continental's design has been thoroughly tested and enthusiastically accepted by broadcasters around the world for transmitter requirements from 50 to 2,000 kW.

Today, our 317C-3 offers customers the highest level of performance from a proven, unmatched heritage.

SPECIFICATIONS

GENERAL

Carrier Power:

Rated	50 kW
Capability	60 kW
Power reduction	25 kW or 10 kW

Modulation:

High-level screen-grid/impedance modulation

Emission:

A3

Frequency Range:

Any single frequency 535-1,620 kHz

Frequency Stability:

±5 Hz

Audio Input:

±10 dBm ±2.0 dB at 100% modulation

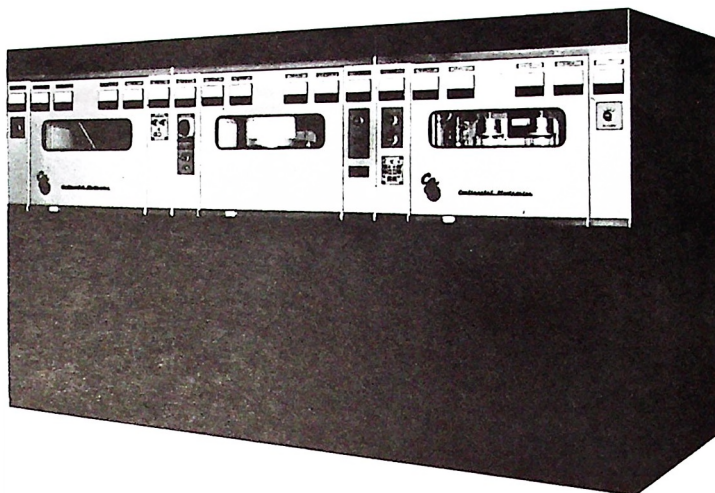

Audio Response:

±0.5 dB, 10 Hz to 7,500 Hz; -1.5 dB, 15,000 Hz reference to 1,000 Hz; at 70% modulation

Phase Response:

±2° from 10 to 1,000 Hz, and phase linear to 30 kHz with output lagging 45° at 15 kHz

Audio Distortion:

Less than 2.5%, 20 to 10,000 Hz at 95% modulation

Intermodulation Distortion:

3.5% at 90% total modulation by SMPTE test method using 60 and 7,000 Hz in 4:1 ratio

Carrier Shift:

2% or less at 100% modulation

Tilt and Overshoot:

Clipped Sinewave:

3% variation in modulation percentage using 6 dB symmetrical clipping, 30 to 10,000 Hz at 90% modulation

Squarewave:

5% variation in modulation percentage, squarewave frequencies from 30 to 7,500 Hz at 60% modulation

Modulation Capability:

100% continuous at any frequency 20-10,000 Hz +125% positive peak with asymmetrical input

Noise Unweighted:

-60 dB below 100% modulation

Spurious & Harmonic Emission:

-80 dB

Output Impedance:

40 to 300 ohms as specified by customer

ELECTRICAL

Power Source:

460V, three-phase, 50/60 Hz, other available on request

Permissible Combined Voltage

Variation:

±5% voltage
±2.5% frequency

Power Factor:

Approximately .95

Overall Efficiency:

Better than 60% at any depth of modulation

OPERATING ENVIRONMENT

Altitude:

7,500 feet (2,286 meters)
Higher by special order

Ambient Temperature:

-4° to 122°F (-20° to 50°C)

Cooling:

Transmitter is air cooled

MECHANICAL

Transmitter:

78" (198 cm) H
144" (366 cm) W
54" (137 cm) D
62 sq. ft. (5.8 sq. m.)

Weight:

4,891 lbs. (2,219 kg)

Plate Transformer:

72" (183 cm) H
24" (61 cm) W
46" (117 cm) D

Weight:

1,990 lbs. (903 kg)

Export Shipping:

Gross weight 9,700 lbs. (4,400 kilos);
800 cubic feet (22.65 cubic meters)

All specifications are subject to change without notice.

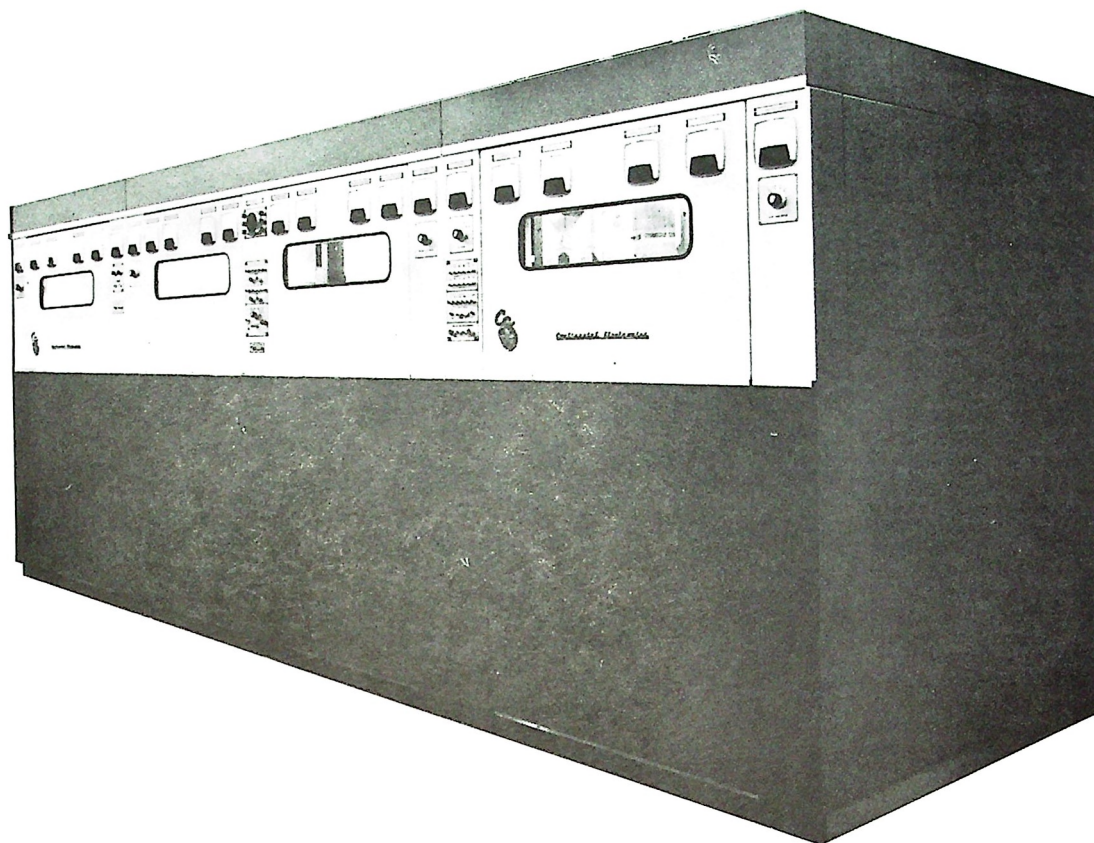

Type 318C and Type 318.5D

Continental's Type 318C is a high performance medium frequency broadcast transmitter that combines state-of-the-art components with a unique circuit design to achieve reliable operation and conservative operating costs.

The Type 318.5D 150,000 watt transmitter is identical to the 318C, except for the power supply, and output power.

The 318C uses the straight-forward simplicity and field-proven reliability of the high-efficiency screen and impedance modulated amplifier.*

Continental's unique design operates both carrier and peak tubes in Class "C" condition, enabling the transmitter to reach very high efficiency while limiting peak voltage to values consistent with reliable operating conditions.

The 4CX35,000A power tubes have a proven record of reliability. The transmitter uses only three tube types.

All low level stages are solid-state.

Continental's Magniphase® antenna protection circuit removes RF within microseconds following an antenna system fault.

The transmitter is air-cooled, and consists of three cabinets. External components are located behind the cabinets. Plate and low voltage distribution transformers are dry type units which do not require installation in a fireproof vault.

SPECIFICATIONS

Carrier Output power:

318C, 100,000 w
318.5D, 150,000 w

Frequency range:

535-1605 kHz

Frequency stability:

Assigned frequency ± 5 Hz (0° to 45° C)

Type of power amplifier:

High efficiency screen and impedance modulated

Output impedance:

200 ohms, unbalanced, or other as specified

Audio Frequency input impedance:

150/600 ohms balanced or unbalanced

Carrier Regulation (shift):

4% or less up to 100% Modulation

Audio frequency input level for 100% modulation:

10 dBm ± 2 dB

Audio frequency response:

± 0.5 dB 100—5,000 Hz ± 1.0 dB 50—7,500

Hz ± 1.5 dB 30—10,000 Hz

Audio harmonic distortion:

4% or less 50 to 7,500 Hz @ 95% modulation

Residual carrier noise:

60 dB or better below 100% modulation

Harmonic and Spurious:

Exceeds CCIR requirements

Modulation capability:

100% 50—10,000 Hz

Overall efficiency:

55% or better

Power line requirements:

460 volts, 3 phase, 3 wire, 50 or 60 Hz,

$\pm 5\%$ regulation (Other voltage if specified)

Export Shipping Data:

Type 318C: 1500 ft³ (42.5 m³),

15,000 lb (6,800 kg)

Type 318.5D: 1500 ft³ (42.5 m³),

15,000 lb (6,800 kg)

*Continental Electronics Mfg. Co. holds the following patents for the high efficiency screen modulated amplifier: Canada 764,605; France 1,432,543; UK 1,044,479; USA 3,314,024.

All specifications are subject to change without notice.

AM-MW Type 319E 250 kW AM-MW Transmitter

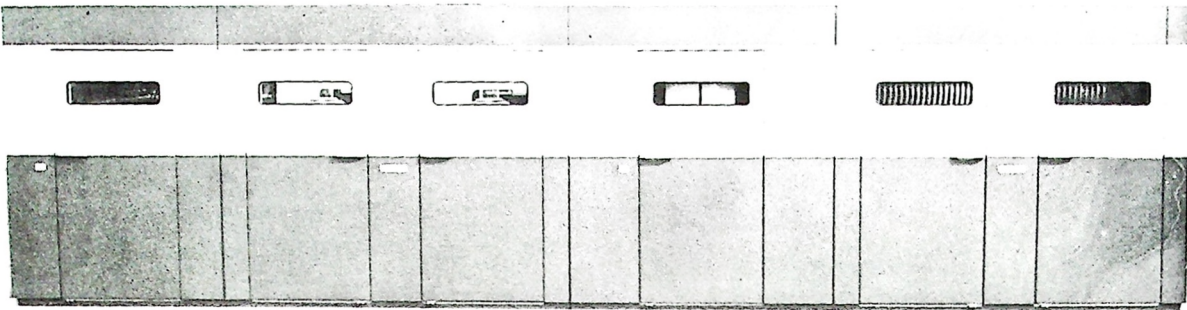

Type 319E

Continental's Type 319E is a medium frequency broadcast transmitter that uses a high efficiency screen and impedance modulated final power amplifier to achieve reliable, cost-effective operation.*

The RF driver stage utilizes two 5CX1500A tubes in a parallel configuration, and is operated Class C.

The RF driver, final power amplifier, second audio amplifier and modulator stages use vacuum tubes; all other circuits use solid state amplifiers.

The RF signal to drive the first RF amplifier stage is provided by a crystal oscillator unit. The RF amplifier and audio stages are installed in the transmitter's main cabinets.

Plate transformers, rectifier assemblies, reactor, filter capacitor bank, distribution system and control circuitry system are located in an area adjacent to the main transmitter. The transmitter is controlled from a control console.

Continental's unique toroidal inductor is used for the peak tank inductance. This unique design achieves a much higher Q than other types of inductors, and because the coil does not produce an external magnetic field, it can be located in a small compartment within the transmitter. The inductors are adjustable for frequency changes.

The transmitter is cooled by a combination of forced air and vapor-phase cooling. The water storage tank is installed within the transmitter cabinet; the heat exchanger is normally installed on the roof of the transmitter building.

Vapor-phase cooling is used to cool the two 4CV250,000B tetrode tubes used in the RF final amplifier.

The remainder of the transmitter is air cooled; forced air is provided by a blower unit located in a room adjacent to the transmitter room.

SPECIFICATIONS

Carrier Output Power:

250,000 Watts

Frequency Range:

525—1605 kHz

Frequency Stability:

Assigned frequency ± 5 Hz (0° to 45°C)

Type of Power Amplifier:

High efficiency screen and impedance modulated

Output Impedance:

200 ohms, unbalanced, or other as specified:

Audio Frequency Input Impedance:

150/600 ohms, balanced or unbalanced

Carrier Regulation (Shift):

4% or less up to 100% modulation

Audio Frequency Input Level for

100% Modulation:

+10 dBm ± 5 dB (or other specified)

Audio Frequency Response:

± 1.0 dB 60—7,500 Hz ± 1.5 dB 30—10,000 Hz

Audio Harmonic Distortion:

3.5% or less 50 to 7,500 Hz @ 90% modulation

Residual Carrier Noise:

60 dB or better below 100% modulation unweighted

Modulation Capability:

100%, 50—10,000 Hz

Overall Efficiency:

56% or better

Power Line Requirements:

4160 volts, 3 phase, 3 wire, 50 or 60 Hz, $\pm 5\%$ regulated (Other voltage if specified)

Export Shipping Data:

Type 319E: 750 ft³ (22.5m³);
25,000 lb (11,250 kg)

*Continental Electronics Mfg. Co. holds the following patents for the high efficiency screen modulated amplifier: Canada 764,605; France 1,432,543; UK 1,044,479; USA 3,314,024.

All specifications are subject to change without notice.

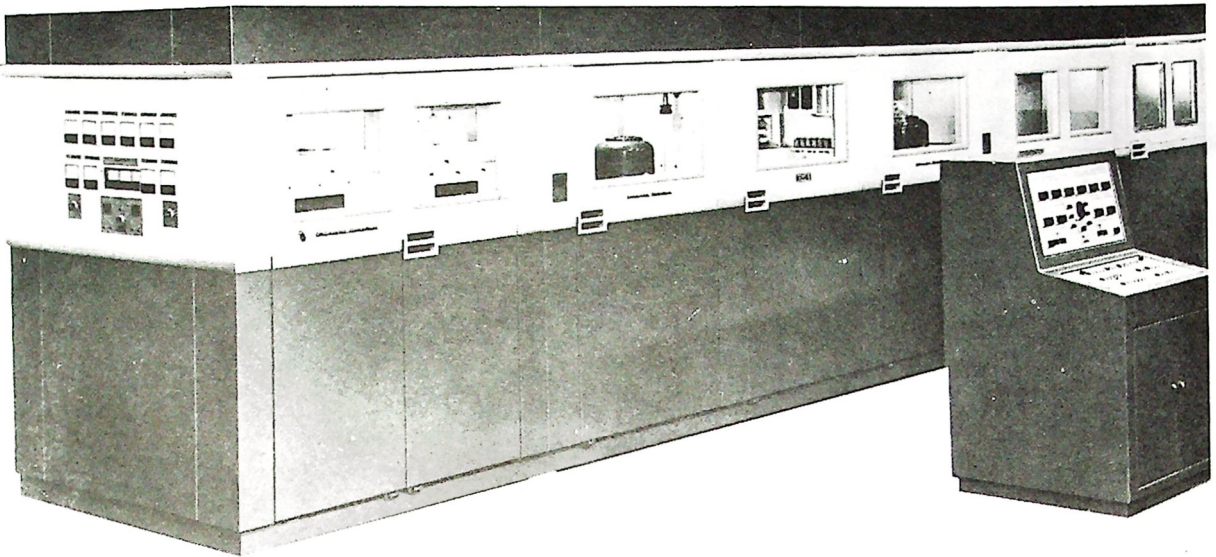

Type 320F

Continental's Type 320F is a high performance medium frequency broadcast transmitter that uses a unique screen and impedance modulation circuit* to achieve extremely reliable, cost-effective operation.

Both carrier and peak tubes are operated in Class "C" condition, offering broadcasters very high efficiency while limiting the peak voltage to values consistent with reliable operating conditions.

The first RF amplifier is solid-state and drives the grid of the IPA.

The intermediate power amplifier employs a single 4CW25000A tetrode with a fixed power output of 10,000 watts.

The final power amplifier utilizes two 8973 water cooled tetrodes which have plate dissipation of 650,000 watts each.

When used in Continental's high-efficiency screen and impedance modulated circuit*, the maximum plate dissipation per tube is less than 200,000 watts for the carrier tube, and less than 120,000 watts for the peak tube with 100% sinewave modulation.

The carrier tube provides the full 500,000 watts power output when no modulation is applied.

Two Type 4CW25000A water-cooled tetrodes are used in the cathode follower modulator stage.

When used in this configuration, the two 4CW25000A tubes have a very high overload capability and thus assure high reliability.

Continental's unique toroidal inductor is used in the peak tank circuit.

This unique design achieves a much higher Q than other types of inductors, and because the coil does not produce an external magnetic field, it can be located in a small compartment within the transmitter. The inductor is adjustable for frequency changes.

The transmitter is cooled by a combination of forced air and pumped water circulation.

The final amplifier, carrier and peak tubes, and the modulator and RF driver tubes are water cooled. The remainder of the transmitter is cooled by low velocity, high volume air.

SPECIFICATIONS

Carrier power output:
525 kW

Type of emission:
Amplitude modulation (A3)

Frequency range:

535 to 1605 kHz

Frequency stability:

±1 part per 10⁷ per month

Modulation system:

High efficiency screen and impedance*

Output impedance:

140 ohms, nominal (other available)

Audio input impedance:

150/600 ohms balanced or unbalanced

Audio input level for 100%

modulation at 1 kHz:

+8 dBm (adjustable ±5 dB or as required)

Audio frequency response:

±1 dB, 50 to 7,500 Hz

±1.5 dB, 30 to 10,000 Hz

Audio harmonic distortion:

3% or less, 50 to 7,500 Hz,

at 90% modulation

Residual carrier noise:

-60 dB, unweighted

-70 dB, C.C.I.R. weighted

Overall efficiency:

60% or better

Export Shipping Data:

Type 320F: 10,500 ft³ (300 m³);

145,200 lb (66,000 kg)

*Continental Electronics Mfg. Co. holds the following patents for the high efficiency screen modulated amplifier: Canada 764,605; France 1,432,543; UK 1,044,479; USA 3,314,024.

All specifications are subject to change without notice.

AM-MW Type 323C 1,000 kW AM-MW Transmitter

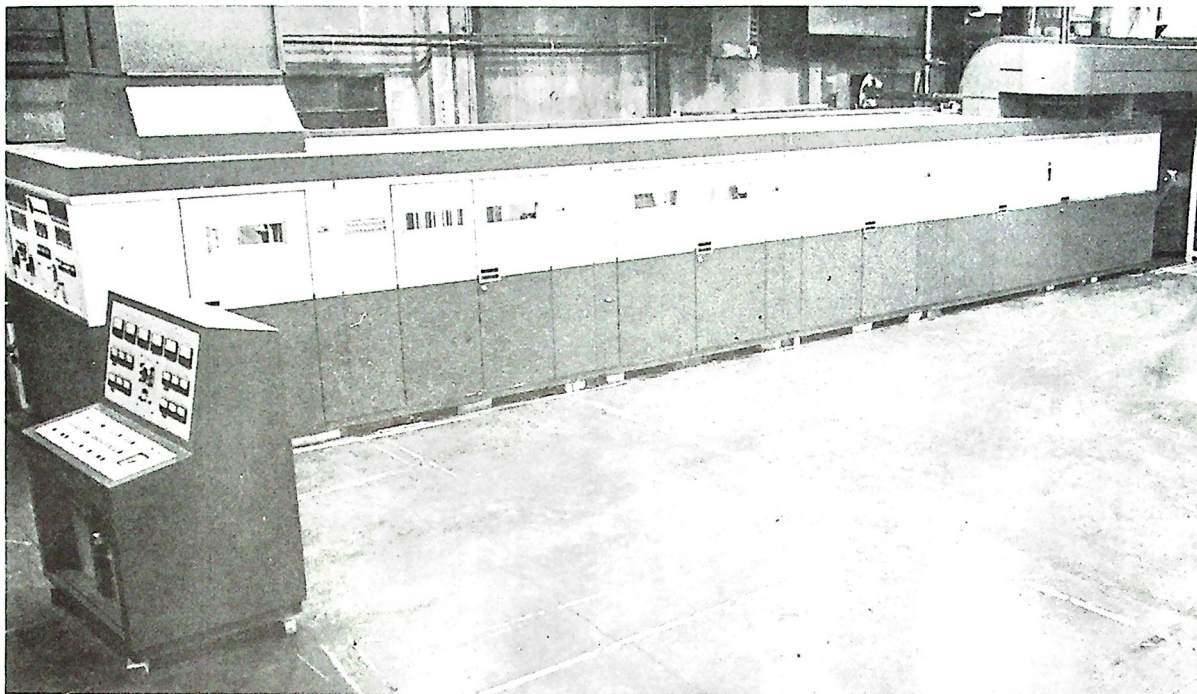

Type 323C

Continental's Type 323C is a high performance medium frequency broadcast transmitter that uses a unique screen and impedance modulation circuit* to achieve extremely reliable, cost-effective operation.

Both carrier and peak tubes are operated in Class "C" condition, offering broadcasters very high efficiency while limiting the peak voltage to values consistent with reliable operating conditions.

The first RF amplifier is solid state and drives the grid of the IPA.

The intermediate power amplifier employs a single 4CW25000A tetrode with a fixed power output of 10,000 watts.

The final power amplifier utilizes two 8974 water cooled tetrodes which have a plate dissipation of 1,250,000 watts each.

When used in Continental's high-efficiency screen and impedance modulated circuit*, the maximum plate dissipation per tube is less than 400,000 watts for the carrier tube, and less than 240,000 watts for the peak tube with 100% sinewave modulation.

The carrier tube provides the full 1,000,000 watts power output when no modulation is applied.

Three 4CW25000A water-cooled tetrodes are used in a cathode follower modulator. In this configuration, the 4CW25000A tubes have a very high overload capability and thus assure high reliability.

Continental's unique toroidal inductors are used in the carrier and peak tank inductor circuits. This unique design achieves a much higher Q than other types of inductors, and because the coil does not produce an external magnetic field, it can be located in a small compartment within the transmitter. The inductors are adjustable for frequency change.

The transmitter is cooled by a combination of forced air and pumped water circulation.

The final amplifier, carrier and peak tubes, and the modulator and RF driver tubes are water cooled. The remainder of the transmitter is cooled by low velocity, high volume air.

SPECIFICATIONS

Carrier power output:
1050 kW

Type of emission:
amplitude modulation (A3)

Frequency range:
535 to 1605 kHz

Frequency stability:
±1 part per 10⁷ per month

Modulation system:

High efficiency screen and impedance*

Output impedance:

140 ohms, nominal (other available)

Audio input impedance:

150/600 ohms balanced or unbalanced

Audio input level for 100% modulation at 1 kHz:

+8 dBm (adjustable ±5 dB or as required)

Audio Frequency response:

±1 dB, 50 to 7,500 Hz

±1.5 dB, 30 to 10,000 Hz

Audio harmonic distortion:

3% or less, 50 to 7,500 Hz, at

90% modulation

Residual carrier noise:

-60 dB, unweighted

-70 dB, C.C.I.R. weighted

Overall efficiency:

66% or better

Export Shipping Data:

Type 323C: 12,075 ft³ (345 m³);

166,980 lb (75,141 kg)

*Continental Electronics Mfg. Co. holds the following patents for the high efficiency screen modulated amplifier: Canada 764,605; France 1,432,543; UK 1,044,479; USA 3,314,024.

All specifications are subject to change without notice.

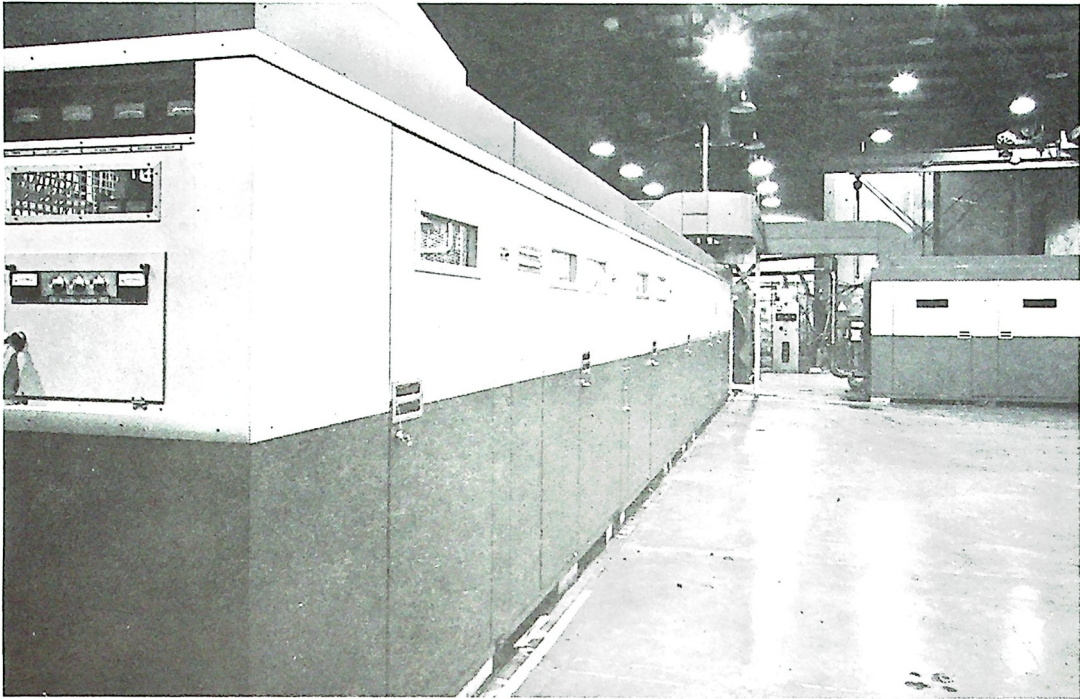

Type D323C

Continental's Type D323C is a high performance medium frequency broadcast transmitter that uses a unique screen and impedance modulation circuit* to achieve extremely reliable, cost-effective operation.

Both carrier and peak tubes are operated in Class "C" condition, offering broadcasters very high efficiency while limiting the peak voltage to values consistent with reliable operating conditions.

In order to increase operating flexibility while improving maintenance factors, the D323C is designed in modules of one-half the operating power level.

Thus, the transmitter consists of two Type 323C 1,000,000 watt transmitters operating in parallel to achieve a total power output of 2,000,000 watts.

The combiner is described in the transmitter combiner section of this catalog.

Each Type 323C 1,000,000 watt transmitter is described as follows:

The first RF amplifier is solid state and drives the grid of the IPA.

The intermediate power amplifier employs a single 4CW25000A tetrode with a fixed power output of 10,000 watts.

The final power amplifier utilizes two 8974 water cooled tetrodes which have a plate dissipation of 1,250,000 watts.

When used in Continental's high-efficiency screen and impedance modulated circuit*, the

maximum plate dissipation per tube is less than 400,000 watts for the carrier tube, and less than 240,000 watts for the peak tube with 100% sine-wave modulation. The carrier tube provides the full 1,000,000 watts power output when no modulation is applied.

Continental cooperated with EIMAC Division of Varian, Inc., in the development of the 8974 tetrode, and thus has unique experience and first-hand knowledge of the effectiveness of the X2159 in high-power transmitters.

Three 4CW25000A water-cooled tetrodes are used in the cathode follower modulator.

When used in this configuration, the 4CW25000A tubes have a very high overload capability and thus assure high reliability.

Continental's unique torodial inductors are used in the carrier and peak tank inductor circuits.

This unique design achieves a much higher Q than other types of inductors, and because the coil does not produce an external magnetic field, it can be located in a small compartment within the transmitter. The inductors are adjustable for frequency changes.

The transmitter is cooled by a combination of forced air and pumped water circulation.

The final amplifier, carrier and peak tubes, and the modulator and RF driver tubes are water cooled. The remainder of the transmitter is cooled by low velocity, high volume air.

SPECIFICATIONS

Carrier power output from combiner:
2100 kW

Type of emission:
Amplitude modulation (A3)

Frequency range:

535 to 1605 kHz

Frequency stability:

±1 part per 10⁷ per month

Modulation system:

High efficiency screen and impedance*

Output impedance:

140 ohms, nominal (other available)

Audio input impedance:

150/600 ohms balanced or unbalanced

Audio input level for 100% modulation

at 1 kHz:

+8 dBm (adjustable ±5 dB or as required)

Audio frequency response:

±1 dB, 50 to 7,500 Hz

±1.5 dB, 30 to 10,000 Hz

Audio harmonic distortion:

3% or less, 50 to 7,500 Hz, at

90% modulation

Residual carrier noise:

-60 dB, unweighted

-70 dB, C.C.I.R. weighted

Overall efficiency:

66% or better

Export Shipping Data:

Type D323C: 27,169 ft³ (776.25 m³);

375,705 lb (170,775 kg)

*Continental Electronics Mfg. Co. holds the following patents for the high efficiency screen modulated amplifier: Canada 764,605; France 1,432,543; UK 1,044,479; USA 3,314,024.

All specifications are subject to change without notice.

Type 416E

Continental's 10 kW short wave broadcast transmitter is a manually tuned, high quality transmitter designed for A3 operation over the frequency range from 3 to 22 MHz.

All operating controls are located on the front of the transmitter for simplicity of operation. Front panel meters monitor all important electrical parameters. The transmitter consists of two cabinets: one cabinet contains the power supply and control circuits, the other cabinet houses the power amplifier. The exciter is housed in a separate rack mounted chassis. High-gain power tetrodes are used in the linear amplifier: one 4CX350A is used for the driver stage; one 4CX35000C tetrode makes up the power amplifier. Superior harmonic attenuation and impedance matching capability is achieved by using a "Pi-L" output network for the power amplifier. Transmitter door interlocks and door-operated high voltage switches protect personnel and equipment. The transmitter is self-contained and occupies 1.9 sq. meters of floor space. The transmitter operates efficiently within an environment of -14°F to 113°F; up to 95% relative humidity; at altitudes up to 5,000 feet above sea level.

SPECIFICATIONS

RF Output Power:

10 kW Carrier;

Frequency Range:

3 to 22 MHz

Radio Frequency Harmonic and

Spurious Output:

50 mw (complies with CCIR recommendations)

Output Impedance:

50 Ohm, 1 5/8" coaxial

Power Source:

208/230/380 volts ac, three phase,
50/60 Hz., 40 KVA

Power Factor:

90%

Audio Input Impedance:

150/600 ohms, balanced or unbalanced

Audio Input level, for 100%

Modulation:

+ 10 dBm \pm 2 dB @ 1000 Hz

Audio Frequency Response:

\pm 1dB 50 to 7500 Hz @ 90% modulation

Audio Frequency Distortion:

Less than 3% RMS 50-7500 Hz
@ 90% modulation

Carrier Regulation (Shift):

5% or less @ 100% modulation

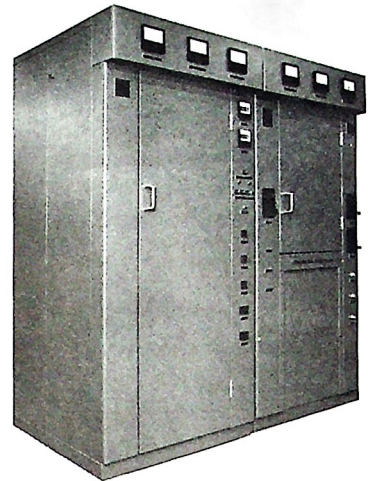

Residual Carrier Noise:

55 db below 100% modulation

RF Sources: (Optional)

Any synthesizer with an output of

1 volt rms across 50 ohms

(Synthesizer Not Included)

Tuning Time:

All tuning controls are accessible from outside of the cabinet except the plug-in plate tuning coil which consists of four (4) bands; maximum time to change from one frequency to a second frequency is approximately four (4) minutes.

Cooling:

Forced Air

Altitude:

5,000 feet (1.52 Km)

Ambient Temperature:

-14°F to 113°F (-10°C to 45°C)

Dimensions:

Width 72" (183 cm)

Depth 41" (104 cm)

Height 78" (198 cm)

Weight:

2,500 lbs (1,134 Kg) net; 3,265 lbs

(1,481 Kg) gross, packed for export

Volume:

290 cubic feet (8.2 cubic meters)
packed for export

All specifications are subject to change without notice.

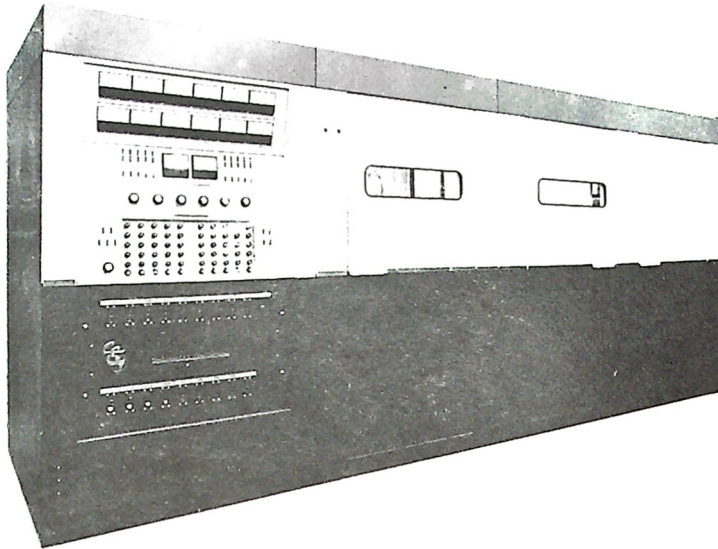

Type 417D

Continental's 50 kW SW broadcast transmitter provides high-performance with optimum efficiency.

A solid-state power hybrid circuit is used to drive the modulator; a broadband solid-state RF amplifier is used to drive the IPA amplifier.

Five tuning controls make initial tuning straightforward and easy.

Fast frequency change (less than one minute) over the frequency range from 3.2 to 22 MHz is provided, and up to 10 preset frequencies can be selected from the front panel without manual tuning.

Two 4CX15000A air-cooled tetrodes operated in a conventional push-pull Class AB₁ modulator, provide high level modulation from 50 to 10,000 Hz.

The power amplifier uses a 4CX35000C air-cooled tetrode operated as a conventional grounded cathode amplifier. The resulting circuit is reliable and simple.

Large, full-width doors allow easy access for maintenance; an automatic grounding system protects operating personnel whenever an access door is opened.

The 417D uses forced-air cooling and ventilation throughout its cabinets; power vaults are cooled by natural convection and radiation.

Control system

Operation of the 417D is simplified by the use of pushbutton control switches which have built-in, lighted function labels that change color to indicate status.

Overall control circuitry is a series-parallel ladder network, with switching, timing, overloads, and other interlock functions arranged in a scientific manner in the network legs to provide a comprehensive protection system.

The preset transmitter tuning system uses dc motors which are controlled by solid-state dc power amplifiers. A pushbutton switch on the control panel activates the tuning system. Multi-turn digital readout potentiometers on the control panel are used for initial positioning and manual tuning.

SPECIFICATIONS

Carrier Output Power:

50 kilowatts

Types of Emission:

Amplitude Modulation (A3) and Frequency Shift (F1)

Type of Modulation:

High-level plate, Class "AB₁" modulator

Final Power Amplifier:

Class "C" operation

Frequency Range:

3.2 to 22 MHz

Output Impedance:

75 ohms unbalanced or 300 ohms balanced (optional). VSWR less than 1.5:1

Modulation Capability:

100%, 50 to 10,000 Hz sinusoidal

Radio Frequency Harmonic and Spurious Output:

Less than 50 mW (Complies with CCIR Recommendations)

Audio Input Impedance:

600/150 ohms, balanced or unbalanced

Audio Input Levels for 100%

Modulation:

+10 dBm ±2dBm at 1000Hz

Audio Frequency Response:

±1 dB from 50-7500 Hz @ 90% Modulation

Audio Frequency Distortion:

Less than 3% rms, 50-7500Hz @ 90% Modulation

Residual Carrier Noise:

55 dB (unweighted) below 100% modulation level at 1000 Hz or better

Carrier Shift:

Less than 3% at 100% Modulation exclusive of power line variations

Relative Humidity:

95 Percent

Altitude:

6000 feet above sea level

Power Consumption:

Unmodulated, 98 kW

Sinusoidal:

30% Modulation	114 kW
50% Modulation	125 kW
100% Modulation	135 kW

Primary Power Requirements:

360 to 480 volt, (±5% regulation), three-phase, 50/60 Hz (other on special order)

Power Factor:

0.9 or better

Ambient Temperature Range:

32°F to +113°F (0°C to +45°C)

Transmitter Size:

Width 192" (487.68 cm)
Depth 60" (152.40 cm)
Height 84 5/16" (214 cm)

Transmitter Weight:

21,500 lb (9752 kg) packed for export

All specifications are subject to change without notice.

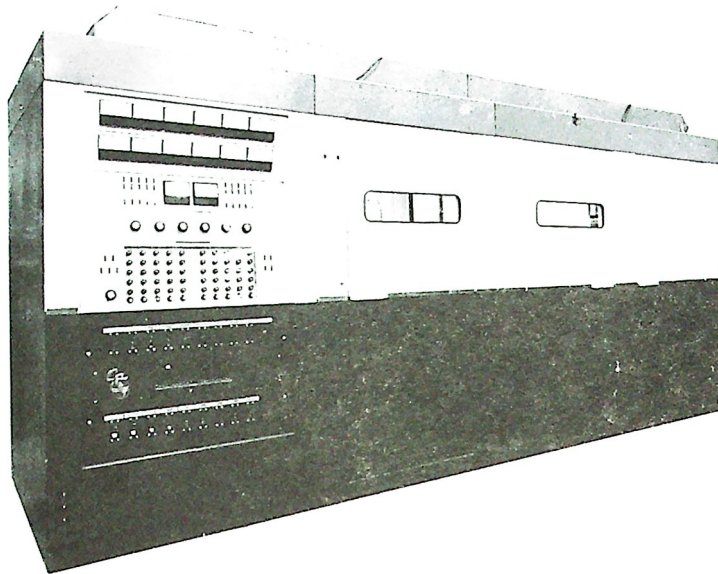

Type 418D-2

Continental's Type 418D-2, 100 kW SW broadcast transmitter is designed for A3 operation over the frequency range of 3.2 to 22 MHz.

The 418D-2 combines the best of semiconductor technology in power supplies with the proven reliability of vacuum tube power stages to provide high-performance, cost-effective operation.

All power tubes are tetrodes. All power supplies use solid-state rectifiers.

Final amplifier and modulator tubes are 4CV100,000C vapor-cooled tetrodes that operate at 70% and 25% respectively of their dissipation capability at 100% modulation.

A 4CX3000A tetrode drives a single 4CV100,000C tetrode final amplifier in a conventional grounded cathode circuit. Solid-state amplifiers are used in all low level audio and RF stages.

Two 4CV100,000C tetrodes, operated push-pull, provide high-level, 100% modulation in Class AB₁.

Modulator and final amplifier tubes are vapor-phased cooled. This cooling system is greatly superior in efficiency to a water-cooled system, removing almost 20-times as much energy.

Five tuning controls make initial tuning straightforward and easy.

Ten preset channels (frequencies) can be selected and activated from the front panel. After initial tuning is accomplished, frequency changes can be made in less than one minute, without additional manual tuning.

The 418D-2 uses a water vapor system to cool the final RF and modulator amplifiers; forced-air cooling is used for the low level tube.

Control system

Operation of the 418D-2 is simplified by the

use of pushbutton control switches which have built-in, lighted function labels that change color to indicate status.

Overall control circuitry is a series-parallel ladder network, with switching, timing, overloads and other interlock functions arranged in a scientific manner in the network legs to provide a comprehensive protection system.

The preset transmitter tuning system uses dc motors which are controlled by solid-state dc power amplifiers.

A pushbutton switch on the control panel activates the tuning system.

Multi-turn digital readout potentiometers on the control panel are used for initial positioning and manual tuning.

SPECIFICATIONS

Carrier Output Power:

100 kilowatts

Types of Emission:

Amplitude Modulation (A3) and Frequency Shift (F1)

Type of Modulation:

High-level plate, Class "AB₁" modulator

Final Power Amplifier:

Class "C" operation

Frequency Range:

3.2 to 22 MHz (2.3 to 26.5 MHz optional at extra cost) (External synthesizer available as separate item)

Output Impedance:

75 ohms unbalanced or 300 ohms balanced (optional). VSWR less than 1.5:1

Modulation Capability:

100%, 50 to 7500 Hz sinusoidal

Radio Frequency Harmonic and

Spurious Output:

Less than 50 mW (Complies with CCIR Recommendations)

Audio Input Impedance:

600/150 ohms, balanced or unbalanced

Audio Input Levels for 100%

Modulation:

+10 dBm ±2d Bm at 1000Hz

Audio Frequency Response:

±1 dB from 50-7500 Hz

Audio Frequency Distortion:

Less than 3% rms, 50-7500 Hz @ 90% Modulation

Residual Carrier Noise:

55 dB (or better) below 100% modulation level at 1000 Hz or better

Carrier Regulation (Shift):

Less than 3% at 100% Modulation exclusive of power line variations

Relative Humidity:

95 Percent

Altitude:

6000 feet above sea level

Power Consumption:

Unmodulated 175 kW
50% Modulation 220 kW
100% Modulation 275 kW

Power Factor:

0.95 or better

Ambient Temperature Range:

+32°F to +113°F (0°C to +45°C)

Primary Power Requirements:

360 to 480 volts, (±5% regulation), three-phase, 50/60 Hz (other on special order)

Transmitter Size:

Width 192" (487.68 cm)
Depth 60" (152.40 cm)
Height 84 5/16" (214 cm)

Transmitter Weight:

26,200 lb (11,884 kg) packed for export

All specifications are subject to change without notice.

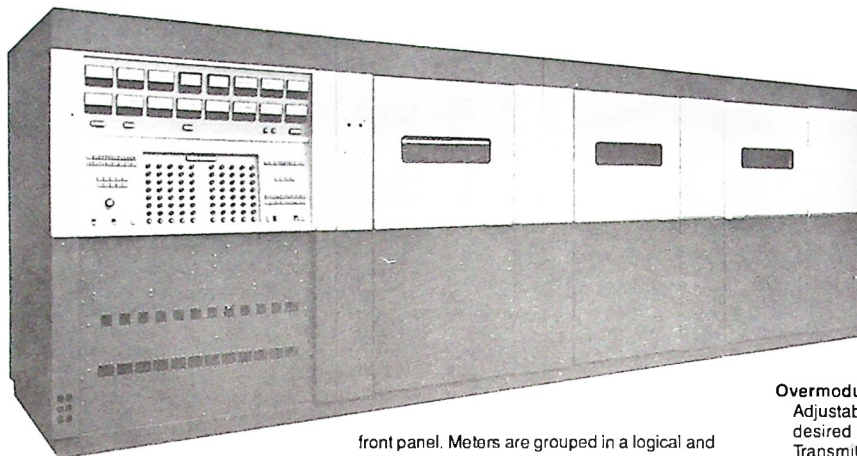

Type 419F-2

Continental's Type 419F-2 is designed for A3 operation over the frequency range of 5.0 to 22.0 MHz.

The 419F-2 combines the best of semiconductor technology in power supplies with the proven reliability of vacuum power tube power stages to achieve high-performance with cost-effective operation.

All power tubes are tetrodes. All power supplies use solid-state rectifiers.

The modulator uses two 4CV100,000C vapor-cooled ceramic tetrodes in a push-pull Class AB₁ circuit. All modulator components are compatible with 100% positive modulation operation.

The RF power amplifier circuit uses one 4CV250,000B tetrode.

Continental's unique single-stage amplifier circuit uses special filament and screen bypass capacitors to achieve very high stability, simplified modulation and tuning throughout the transmitter's frequency range.

All transmitter control and monitoring can be accomplished from a single front panel.

Seven tuning controls make tuning straightforward and easy.

Ten preset channels (frequencies) can be selected and activated from the front panel.

After initial tuning is accomplished, frequency change can be made in less than one minute, without additional manual tuning.

The 419F-2 uses a water vapor system to cool the final RF and modulator amplifiers; the RF drive tube, output tuning and loading components are water-cooled; forced-air cooling is used for other transmitter components.

Control system

The 419F-2 uses a 24 volt dc control system. Most control functions use conventional electro-mechanical control logic.

Basic control circuitry is in a familiar series parallel ladder; switching, timing and interlocking functions are arranged in a logical and consistent pattern.

The transmitter has all instruments necessary for operational adjustment and maintenance procedures.

All major operating parameters are displayed on easy-to-read meters which are located on the

front panel. Meters are grouped in a logical and functional manner.

Multi-colored indicators on the front panel give status of various interlock and control system logic.

SPECIFICATIONS

Carrier Output:

250,000 watts, minimum

PEP Output (SSB optional mode):

500,000 watts, minimum

Modulation:

Pulse-width modulator (PWM)

Emission:

A3E or A3J (USB)

Frequency Range:

International broadcast bands, 10 preset channels 3.9 to 22 MHz

Frequency Control:

Frequency synthesizer

Frequency Stability:

1x10⁻⁸ per day, optional greater stability available on special order

AF Input Impedance:

600 Ohms, 30 dB return loss

AF Input Level for 100%:

Sinewave modulation +10 dBm ± 2 dB continuously adjustable, other levels optional

AF Response:

±1 dB 50 to 4,500 Hz
±2 dB 4,500 to 6,000 Hz

Referred to 1,000 Hz at any modulation level

AF Distortion:

Less than 3% THD, 50 to 4,500 Hz at any modulation level up to 100% positive and negative

SSB Option

SSB Carrier Suppression:

-6 or -12 dB selectable

SSB Unwanted Sideband Suppression:

-55 dB

SSB Odd Order IM Products:

-30 dB (two tone test)

Carrier Shift:

1.5% or less including power line variations of up to 2%

Modulation Capability:

100% positive and negative modulation continuously by program, band limited noise or sinewave modulation 50 to 6,000 Hz at any power level up to 250 kW

Controlled Carrier Modulation:

0 to 6 dB carrier reduction in 1 dB increments

Overmodulation:

Adjustable peak clipping may be set to desired maximum modulation level. Transmitter will accept input level of 10 dB over 100% without damaging equipment. AF input exceeding 10 dB over 100% modulation level may cause protective overload circuits to operate.

Residual Carrier Noise:

55 dB unweighted below 100% modulation at 1,000 Hz measured in a bandwidth of 10 to 15,000 Hz

RF Harmonic and Spurious

Output Level:

Less than 2.5 milliwatts up to a maximum frequency of 900 MHz

Output Impedance:

75 Ohm unbalanced - standard
300 Ohm balanced - optional
Maximum allowable VSWR 1.8:1.0 at full power

Power Source:

4160 volts, three phase, three wire, 50/60 Hz (others optional on special order)

Power Factor:

Better than 0.95

Power Consumption:

Maximum input power 568 kW at 100% sinewave modulation

Efficiency:

65 to 70% at 250 kW carrier power output, depending on the ambient temperature and operating frequency; typically 66% at any modulation depth

Maximum Operating Conditions:

Altitude - 2,000 feet (600 meters)
Ambient temperature - 10 to 45°C
Relative humidity - 95%

Dimensions:

Main cabinet group -

7' (2.13 m) H

22' (6.71 m) W

6' (1.83 m) D

Modulator group -

7' (2.13 m) H

12' (3.66 m) W

6' (1.83 m) D

Power supply vault -

(dependent on building layout)

8' (2.44 m) H

21' (3.66 m) W

14' (4.27 m) D

Weight and volume

(packed for export)

38,000 lbs (17,100 kg)

2,800 cubic ft. (79.29 cubic meters)

All specifications are subject to change without notice.

AM-SW Type 420B-1 500 kW AM-SW Transmitter

Type 420B-1 Overview

- User friendly
- Simplified control & operation
- High-efficiency pulse width modulation
- High-efficiency RF amplifier
- Rugged output cavity
- Low current contacts
- Efficient multi-phase cooling on power amplifier tube
- Full remote control capability
- On-board computer control
- Options: SSB operation, tuned balun, dummy load, dynamic carrier control

GENERAL

Designed for continuous A3 operation over the frequency range of 3.9 to 26.1 MHz, the Type 420B-1 is a versatile, state-of-the-art, high performance, high-efficiency, user friendly transmitter. It's designed for easy, confident operation from the central control panel in front of the transmitter, or with a video terminal from a remote location via the RS-232 or similar system. An on-board computer, the Intel 80/10B, provides remote and local status monitoring/metering, storage and retrieval of servo positions for 255 channels, and storage and retrieval of transmitter logs. The computer can be connected to an optional external printer and video terminal.

The transmitter can be set up and either pretuned or automatically tuned to deliver 500,000 watts of carrier power on any frequency between 3.9 and 26.1 MHz in less than 30 seconds in or out of the *International Shortwave Broadcast Bands*. Typical average tuning time for 10 auto-tune frequencies is 15 seconds. The left side of the control panel shows the status of all transmitter functions in a quick and easy-to-read manner. The right side has a numerical entry pad for tuning the transmitter by hand.

The three-stage RF amplifier consists of a broadband solid-state amplifier, grounded-grid 3CW20,000A7 triode, and a 4CM400,000 tetrode final power amplifier.

The modulator is a series hard tube floating deck pulse-width modulator consisting of one 4CM400,000 tetrode driven by a solid-state MOSFET driver. Continental's patented circuits control negative modulation to achieve 100% modulation without distortion. Modulator efficiency is better than 90%.

Tuning is accomplished with a large, highly efficient transmission line coupled cavity. 32 spring-loaded, pneumatically-driven silver-graphite points distribute current flows to less than 8 amps per point. After coarse tuning, capacitors resonate the circuit.

The 420B-1 offers maximum performance and reliability with basic, easily-understood circuitry. Efficient tuning and matching circuits in the RF amplifier maintain a constant and optimal circuit-Q over the entire tuning range. In operation, the transmitter is virtually transparent and handles audio processing without degrading it.

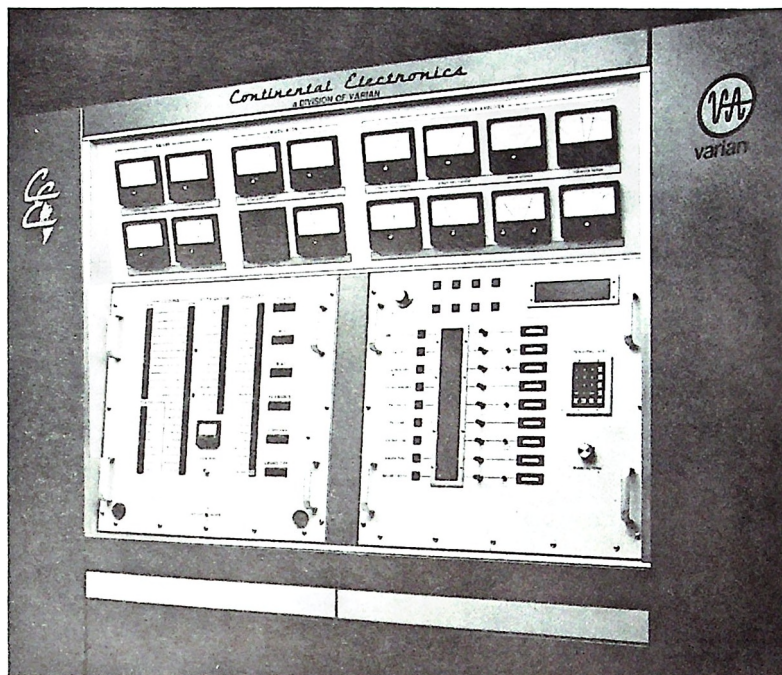

SPECIFICATIONS

Carrier Output:
500 kW

Modulation:
Pulse-width modulator

Emission:
A3

Frequency Range:
3.9 to 26.1 MHz

AF Input Impedance:
600/150 ohms, balanced or unbalanced

AF Input Level
for 100% Sinewave Modulation:
-5 dBm to +10 dBm

AF Response:
±1 dB 50 Hz to 7.5 kHz

AF Distortion:
Less than 4% THD 50 Hz to 7.5 kHz at 95% modulation

Carrier Regulation (Shift):
Less than 3% exclusive of power line variations

Modulation Capability:
100% positive and negative peaks 50 Hz to 7.5 kHz sinewave for 10 minutes per hour; up to 80% modulation continuously

Residual Carrier Noise:
60 dB or better unweighted below 100% modulation at 1 kHz

RF Harmonic Output and Spurious Output:
Below 75 dB

Output Impedance:
50 or 75 ohms unbalanced, or 300 ohms balanced (optional)

Maximum VSWR:

1.7:1

Power Source:

4160 volts ac, three phase, 50/60 Hz
(Other on special order)

Power Factor:

0.9 or better

Power Consumption:

Carrier-modulated: 100% Sinewave,
1150 KVA, max.; Carrier-unmodulated:
770 KVA, max

Efficiency:

65% to 72% depending upon the ambient temperature and operating frequency; typical efficiency is 70%

Exciter:

Any suitable exciter with 0.5 watt output,
3.9 to 26.1 MHz

OPERATING ENVIRONMENT

Altitude Range:

Sea level up to 6,000 ft (1828.8 m)

Ambient Temperature Range:

+32°F to +122°F (0°C to +50°C)

Relative Humidity:

Up to 95%

Size:

4300 ft³ (129 m³)

Weight:

47,300 lb (21,285 kg) nominal,
packed for export

All specifications are subject to change without notice.

Transmitter Combiners

Introduction

Many of Continental's medium power AM and FM, and high-power AM broadcast transmitters can be combined to achieve higher power output levels.

Continental 20,000 watt, 25,000 watt and 27,500 watt FM transmitters can be combined to develop 40,000 watts, 50,000 watts and 55,000 watts output, respectively. Each of these higher power transmitters are type approved by the FCC.

Continental 10,000 and 50,000 watt AM transmitters can be combined to develop 20,000 and 100,000 watts output.

Continental high-power broadcast transmitters utilize combiners to increase operating factors: Two Continental Type 318C 100,000 watt transmitters can be combined to develop 200,000 watts output power; Two Continental Type 318.5C 150,000 watt transmitters can be combined to develop 300,000 watts output power; Two Continental Type 320F 500,000 watt transmitters can be combined to develop 1,000,000 watts output power; Two Continental Type 323C 1,000,000 watt transmitters can be combined to develop 2,000,000 watts output power.

Continental transmitters and combiners are used by broadcasters around the world to meet unique transmitter power or station operating requirements.

Combiners for Dual Transmitter Operation

Continental combiners are built for many years of service. All combiners are housed in a cabinet that matches the cabinets of the transmitters to be combined with the combiner typically placed between the two transmitters.

A convection-cooled waster load is located within the combiner cabinet. If a load is required for the combined transmitter, this load is located external to the combiner cabinet.

Control consoles for combined transmitters are available. The console provides the necessary controls and supervisory functions for operation of the combined system.

Continental engineers stand ready to assist in the planning of a combined transmitter facility. Architectural data, building accommodations and equipment installation is available and customized to required specifications.

Combiner circuit

The combining circuit provides complete isolation of one transmitter from the other. Thus the load resistance is constant and independent of differences between the two transmitters: the output of one transmitter may be open or short circuited without affecting the other. As an option, the combiner can be built so if one transmitter fails, the full power of the remaining transmitter will be delivered to the antenna.

Waster load

The waster load terminates networks of the combiner from each transmitter. When both transmitters are in phase and equal in power, there will be no power in the waster load. This method allows maximum power to be delivered to the antenna.

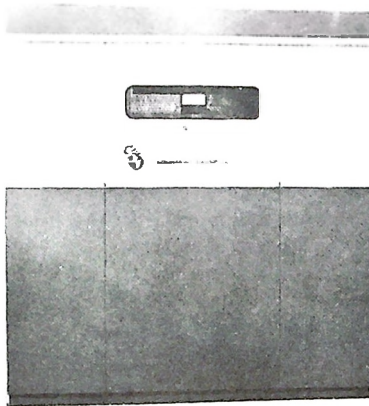

100 kW Combiner

Continental 100kW combiner is used to combine the output of two Continental Type 317C-3 50,000 watt AM broadcast transmitters.

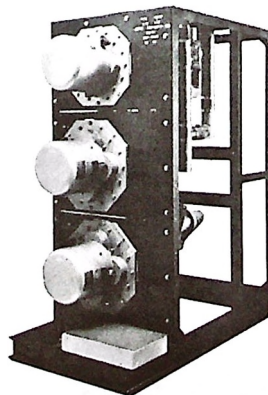

Combiner for Type 817R-1 50,000 watt, Type 817-4 55,000 watt, Type 817-5 70,000 watt FM Transmitters

Continental's 817R-1B combines two Type 816R-3B 25,000 watt transmitters to achieve

50,000 watts of output power. The Type 817R-4B combines two Type 816R-4B 27,500 watt transmitters to achieve 55,000 watts of output power. The Type 817R-5B combines two Type 816R-5B 35,000 watt transmitters to achieve 70,000 watts of output power.

The combining is accomplished in a 90 degree hybrid coupler that may be used alone or in conjunction with motor activated coaxial switches. The motor activated switch and coupler assembly is appropriate for automated switched operation of combined transmitters. The hybrid coupler introduces less than 0.1 dB loss and no more than a 1.1 VSWR in a 50 ohm system. Isolation between the combined transmitters is at least 30 dB.

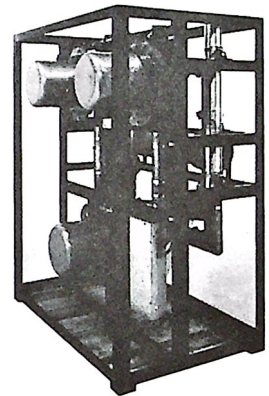

Combiner for Type 817R-2A 40,000 watt FM Transmitter

Continental's 817R-2AB consists of two Type 816R-2AB transmitters combined to achieve 40,000 watts of output power.

The combining is accomplished in a 90 degree hybrid coupler that may be used alone or in conjunction with motor activated coaxial switches. The motor activated switch and coupler assembly is appropriate for automatic switched operation of combined transmitters. The hybrid coupler introduces less than 0.1 dB loss and no more than a 1.1 VSWR in a 50 ohm system. Isolation between the combined transmitters is at least 30 dB.

All specifications are subject to change without notice.

Transmitter Combiners

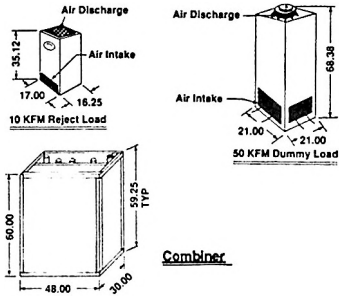

Combiner & Transmitter Dummy Load Configurations for 40 kW FM Transmitters

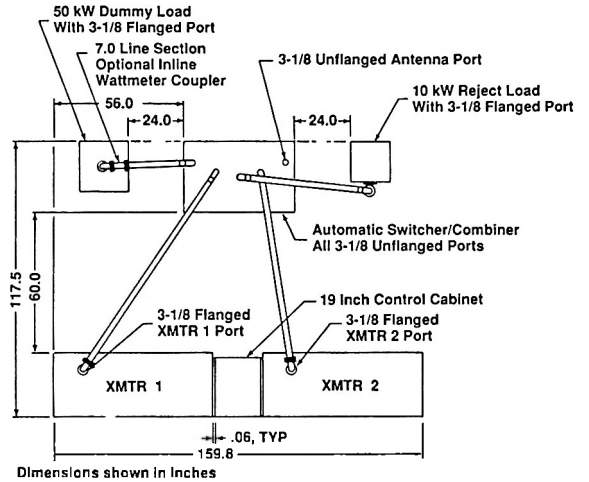

Typical Plan View, 40 kW FM Transmitters

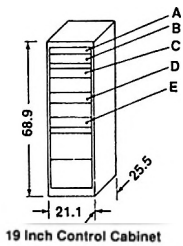

- A. Power Monitor Panel
- B. 377D-1 Automatic Combiner Control
- C. 802A Exciter No. 1
- D. 377C-1A Automatic Exciter Control
- E. 802A Exciter No. 2

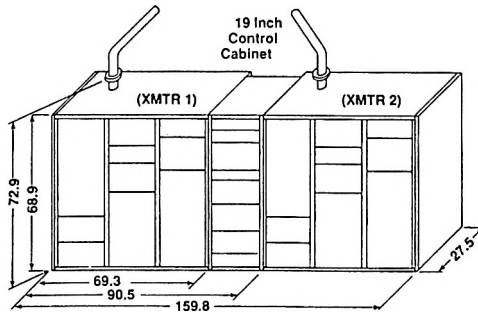

Typical Set-up: 40 kW FM Transmitters

Transmitter Combiners

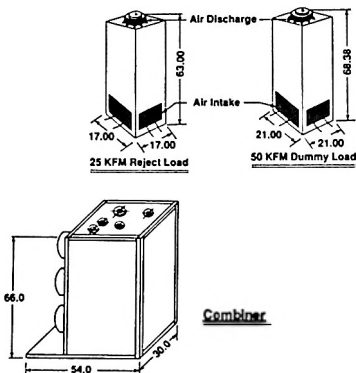

Combiner & Transmitter Dummy Load Configurations for 50,55 kW FM Transmitters

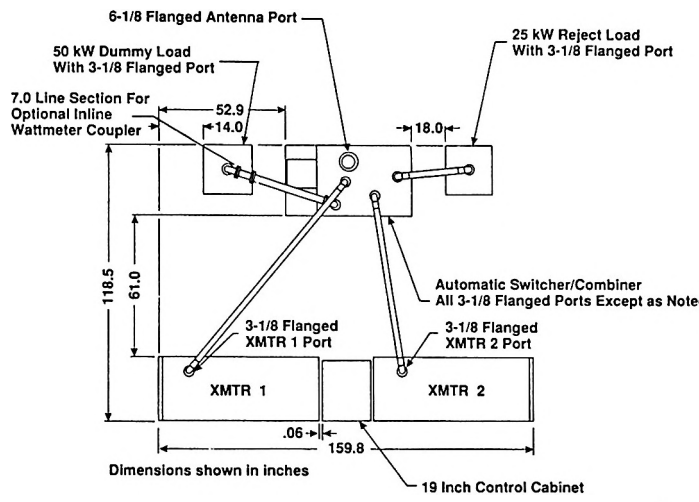

Typical Plan View, 50 & 55 kW FM Transmitters

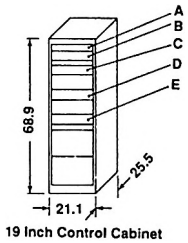

- A. Power Monitor Panel
- B. 377D-1 Automatic Combiner Control
- C. 802A Exciter No. 1
- D. 377C-1A Automatic Exciter Control
- E. 802A Exciter No. 2

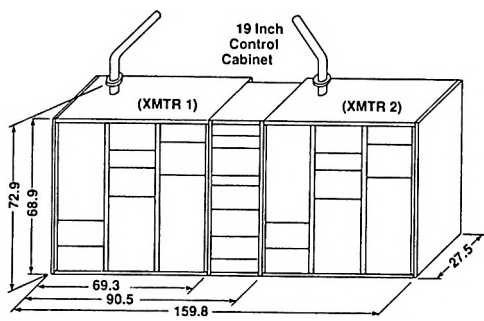

Typical Set-up: 50, 55 kW FM Transmitters

Transmitter Combiners

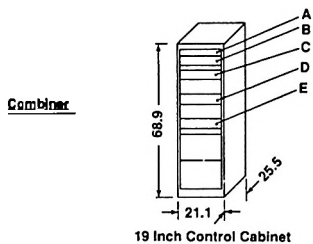
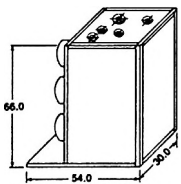
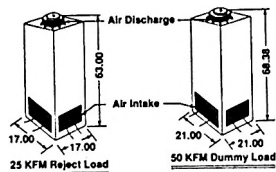
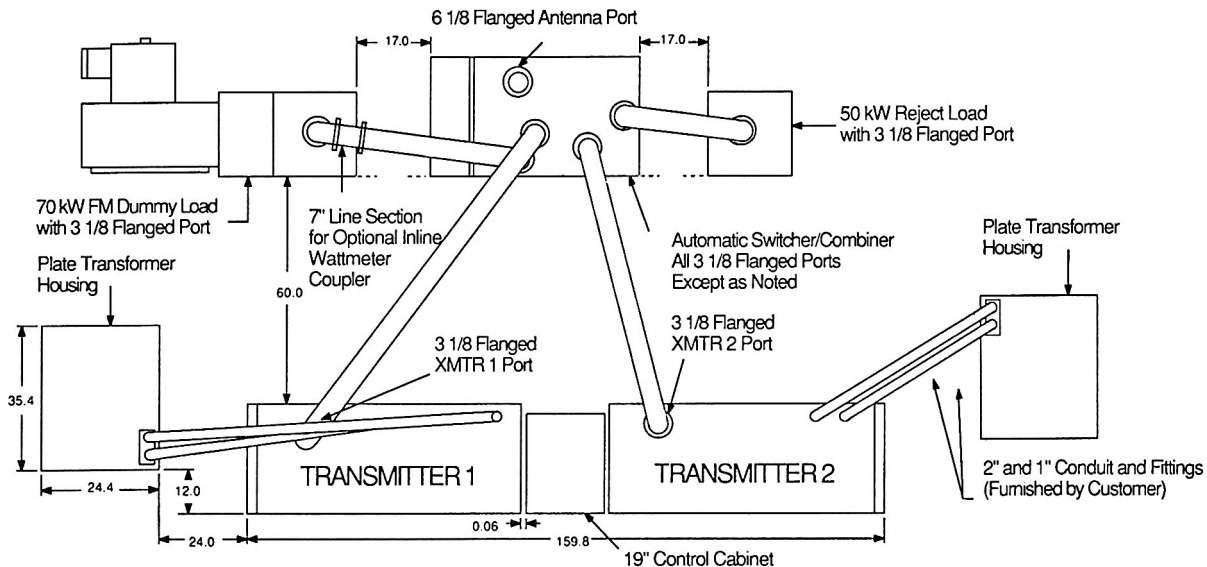

- A. Power Monitor Panel
- B. 377D-1 Automatic Combiner Control
- C. 802A Exciter No. 1
- D. 377C-1A Automatic Exciter Control
- E. 802A Exciter No. 2

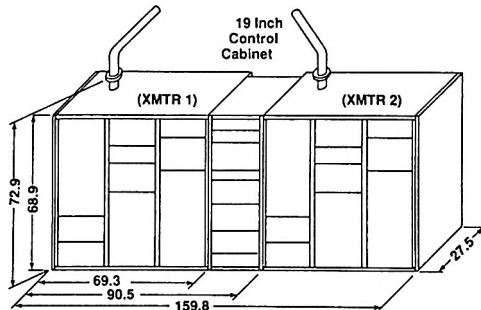

Typical Set-up: 70 kW FM Transmitters

Transmitter Dummy Loads

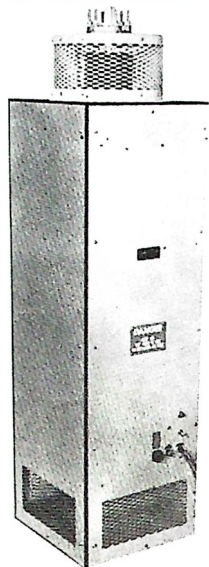

Electro Impulse Model
DPTC-25KFM FM Dummy Load

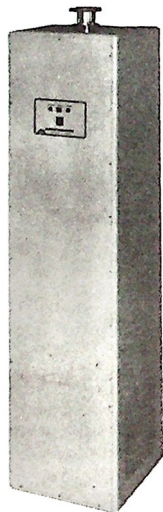

Omegaline Model 6725
25 kW Dummy Load

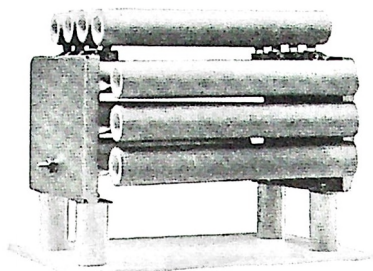

**Type 314DL-1,
1,000 watt Dummy Load**

Continental's 314DL-1 is a convection air cooled dummy load that will handle a 1,000 watt transmitter at 125% modulation. It is supplied with 50 ohms resistance and with stud connection.

Size: 10" wide, 12" long, 9" high
Weight: 12 lbs.

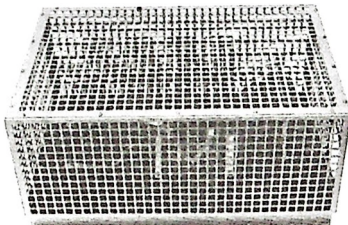

**Type 516DL-1, 5,000/10,000
watt Dummy Load**

Continental's 516DL-1 is a convection air cooled dummy load that will handle a 5,000 or 10,000 watt transmitter at 125% modulation. It is supplied as an essentially flat load, including "L" network, on the customer's frequency and impedance in the standard medium wave broadcast band. A Delta TCA ammeter and 1-5/8" EIA termination are optional. Coil and capacitor sizes vary with frequency and impedance.

Size: 40" wide, 12" high, 26" deep
Weight: 60 lbs.

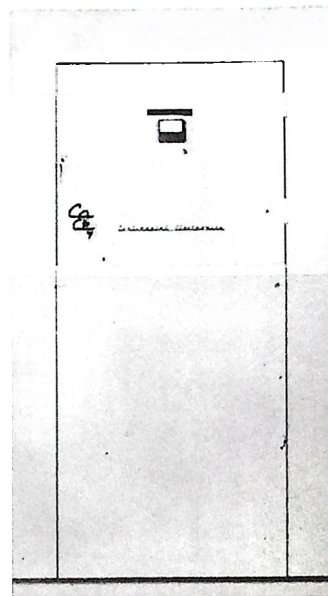

**Type 517C-2,
50,000 watt Dummy Load**

Continental's 517C-2 is an air-cooled RF dummy load designed for continuous and reliable operation over the frequency range of 535 to 1620 kHz. The "L" network is adjusted at the factory.

The load is designed for use with 50,000 watt AM broadcast transmitters to provide a load for the RF power amplifier for testing purposes, or when it is not desirable to radiate RF output. The load will handle a 50,000 watt AM transmitter at 125% modulation.

SPECIFICATIONS

Frequency range: 535 to 1620 kHz

Power dissipation: 75kW

Resistance: Factory-adjusted to customer's transmitter RF output impedance

RF connections: Insulator "bowl" on top of cabinet

Size: Width 42" (107 cm)

Depth 40" (102 cm)

Height 78" (198 cm)

Weight: 950 lbs (431 kg)

All specifications are subject to change without notice.

Electro Impulse rf Loads					Size			Wt lb (kg)	Reqd Pwr (v ac 1 phase)
Model	Avg Pwr (Kilowatts)	Freq Range (dc MHz)	Max VSWR	EIA Connector in (cm)	D in (cm)	W in (cm)	H in (cm)		
DPTC-10KFM	10/12	108	1.2:1	3 1/8 (7.9)	11 (27.9)	16 (40.6)	38 (96.5)	37 (16.8)	110
DPTC-25KFM	25	108	1.2:1	3 1/8 (7.9)	17 (43.1)	17 (43.1)	63 (160)	100 (45.4)	110
DPTC-50KFM	55	108	1.2:1	6 1/4 (15.5)	21 (53.3)	21 (53.3)	65 (165.1)	120 (54.4)	220
DPTC-75KFM	80	108	1.25:1	6 1/4 (15.5)	26 (66)	26 (66)	65 (165.1)	150 (68)	220

Transmitter Dummy Loads

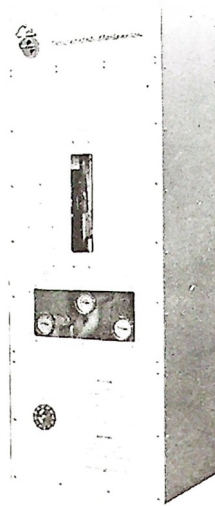

Continental Type DL-418 100 kW Dummy Load

Continental's Type DL-418 is a high-power RF dummy load designed for continuous and reliable operation over the frequency range from 0.1 to 100 MHz. The dummy load can be used without power derating over its full frequency range. Measured VSWR is less than 1.1:1. The load, including its external heat exchanger and coolant tank, is equipped with an external interlock control having interface connections via a terminal board. Ambient operating temperature range is from 32° to 110°F (0° to 44°C). An ethylene glycol mixture (35%) can be used to extend lower temperature range. 50 Hz operation and a calorimeter panel are available at additional cost. Measurement accuracy of the optional calorimeter is better than 5%.

SPECIFICATIONS

Power Rating: 100 kilowatt average;
200 kilowatts PEP.

Impedance: 50 OHMS (unbalanced)

Frequency Range: 0.1 to 100 MHz

VSWR: Less than 1.1 to 1 to 100 MHz

Power Required: 230 VAC, 20A,
3 phase, 60 Hz (50 Hz optional)

Service: AM, FM, TV, SSB, FSK or C.W.

Duty Cycle: Continuous

Size (Load Unit Only):

Width 2 ft. (61 cm)
Depth 1.5 ft. (46 cm)
Height 6 ft. (183 cm)

Shipping Weight: 2500 Lbs. (1134 kg)
includes load, heat exchanger and
coolant tank (crated)

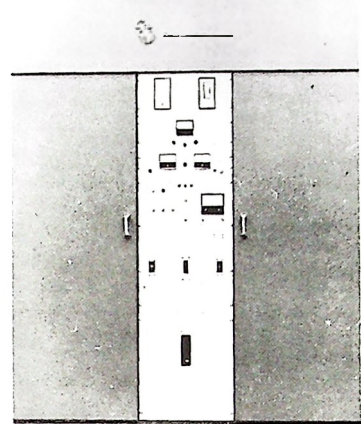

Continental Type 4L23** 1,000 kW Dummy Load

Continental's Type 4L23 is a high-power RF dummy load designed for continuous and reliable operation over the frequency range from 30 Hertz to 40 MHz. The load is available in three configurations: Type 4L23-1 for 50 ohm unbalanced input; Type 4L23-2 for dual 50 ohm inputs; Type 4L23-3 for 300 ohm balanced input. Pre-heated liquid element dissipators have a VSWR of less than 1.2:1 under stabilized conditions. VSWR is less than 1.3:1 within 20 seconds after a substantial change in load dissipation (ie, 200 kW to 1000 kW). Cooling is provided by an internal liquid-to-liquid loop, and an external liquid loop.

Front panel control and monitoring can be modified for remote control and monitoring. Interlock line control protects the dummy load and RF power source. Calorimetric power measurement and water flow indicator meters are mounted on front panel. Ambient operating temperature range is from 32° to 110°F (0° to 44°C).

SPECIFICATIONS

Power Rating:

1000 kW Average; 2000 kW Peak

Impedance: 4L23-150 ohms* unbalanced,
4L23-2 two 50 ohm* unbalanced inputs,
4L23-3 300 ohm* balanced (two 150 ohm
inputs)

Frequency Range:

30 Hz to 40 MHz (broadband)

VSWR (Maximum): 1.2:1 after 20 seconds
(maximum) of stable power input; 1.3:1 during
first 20 seconds (maximum) after a power
change of up to 5 to 1.

Duty Cycle: Continuous

Service: AM, FM, FSK, TV, SSB or CW

Power Required: 230 vac ±10%,
single phase, 50/60 Hz, 13 KVA. (other
voltages upon request)

Size: Width 6 ft (183 cm); Depth 4 ft (122 cm);
Height 10 ft (305 cm)

Shipping Wt: Approx. 2000 Lb. (907 kg)
(excludes external heat exchanger)

* varies slightly — dependent upon dissipator temperature,
refer to VSWR specification

** U.S. Patent No: 3,742,188

Transmitter Control Accessories

TRANSTAT™ I

- Transmitter Monitoring and Remote Controller
- For Continental FM Transmitters
- Programmable Functions for 12 Months in advance
 - Power Up/Power Down
 - FM Antenna Heaters ON/OFF
- Provides Data storage for all Pre-Failure and Fault conditions by milliseconds, seconds, minutes, hours, day, and month for trend tracing
- Read-out of Basic Transmitter Metering:
 - PA Voltage
 - PA Current
 - Forward Power
 - Reflected Power
 - Calculated Antenna VSWR
 - Screen Voltage and Current
 - IPA Fwd/Reflected Power
 - 3-Phase AC Voltages
 - Inlet/Outlet Temperature
- Read-out of Transmitter Status:
 - Plate ON/OFF
 - Filament ON/OFF
 - Air Flow OK
 - Power Control:
 - AUTO/MANUAL
 - REMOTE/LOCAL
- Remote Output to Modem for External PC Interface
- Automatic Log Printing (with optional printer)
 - Logs stored automatically by hour, day, and month
- Data stored in Non-Volatile Memory for CRT viewing at any time
- User Defined:
 - Limits and Alarms for Selected Parameters
 - External Equipment Control
 - External Equipment Monitoring/Status
 - A/D Channels for External Uses P/N 172236-1

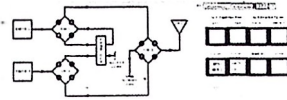

Type 377D-1 Combiner Control

Continental's Automatic Combiner Control provides control commands and monitoring for a pair of parallel transmitters and their associated motor-driven coax switches.

By monitoring predetermined parameters, the Type 377D-1 can switch one transmitter directly into the antenna system and thereby avoid the normal power loss of 6 dB that takes place in a hybrid combiner.

If one PA fails, the down unit is automatically switched to a dummy load for service.

System status is shown by a series of 12 LEDs, and a flow chart gives a quick visual reference from a distance. Eight (8) illuminated push-buttons program the Type 377D-1.

Operating modes include: combined power to load; combined power to antenna; transmitter 1 or 2 to antenna; transmitter 1 or 2 Plate On or Plate Off; and Manual or Automatic operation.

The Type 377D-1 uses IC logic to give status and command functions, and has its own ni-cad power supply across the dc lines to hold memory during a power failure. After a primary power failure, transmitter operation will automatically resume in its last mode.

The Type 377D-1 occupies 5-1/4" of rack space, has standard BNC connectors on the back for RF connections, and uses barrier strips for control connections.

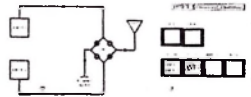

Type 377D-2 Transmitter Control

Continental's Automatic Transmitter Control is similar in operation to the Type 377D-1 except that it controls two transmitters in an alternate/main or "hot standby" condition.

The Type 377D-2 has a ni-cad power supply across the dc lines to hold memory during a power failure.

Front panel controls include Transmitter 1, Transmitter 2, Plate On, Plate Off, Manual, Automatic. An LED flow chart shows rf routing to an antenna system and dummy load.

The Type 377D-2 occupies 5-1/4" of rack space, has standard BNC connectors on the back for rf connections, and uses barrier strips for control connections.

Type 377D-2A Option

Continental's Type 377D-2A is the same as the Type 377D-2 except that it has a sensing device to monitor transmitter audio level.

If the audio drops below a preset level, the 377D-2A automatically switches the down unit into a dummy load and puts the alternate/hot standby transmitter on the air.

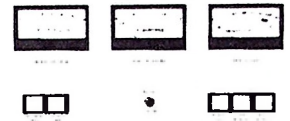

AM extended control & meter panel

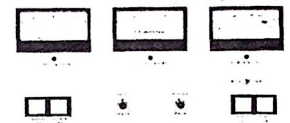

FM extended control & meter panel

AM and FM Extended Control Panels

AM and FM transmitter extended control panels can be provided for the situation where the operator cannot view the transmitter but must be able to control it and read critical meters. The AM control panels provide meters for reading plate voltage, plate current, and RF line current. Controls are provided for filament on/off, raise/lower power, plate off, low power, and high power. The FM control panels provide meters for reading plate voltage, plate current, and power output with provisions for reading reflected power. Controls are provided for filament on/off, raise/lower power, stereo-mono mode, plate on, and plate off. These panels will satisfy FCC requirements (Code 73.276) for operation of the transmitter in the same building, on the same floor, or not more than one story above or below the transmitter location and where the operators ready path to the transmitter is not more than 30.5 m (100 ft). Other situations require the use of a remote control system. All panels are the rack-mounting type.

Size:	Weight:
48.3 cm (19") W	31.7 kg (7 lb)
17.78 cm (7") H	
13.9 cm (5 1/2") D	

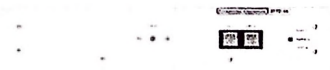

Type 377C-1A Exciter Control

Continental's Automatic Exciter Control monitors the status and controls two exciters.

During typical operation, the Type 377C-1A switches one exciter to the transmitter to be driven. The second exciter is operated into a 100-watt load provided with the unit. If the primary exciter fails, the standby exciter is switched on line in less than 100 milli-seconds. If used with Continental Type 802A FM exciters, the standby exciter is held at 5% of normal power by a bias voltage from the Type 377C-1A until full power is needed.

Front panel controls include Operate/Standby push-buttons for both exciters, and a Normal/Test switch for station monitors.

The Type 377C-1A occupies 3-1/2" of rack space and uses BNC connectors for RF connections and a barrier strip for control connections.

Transmitter Control Accessories

TRANSTAT™ II

- Transmitter Monitoring and Remote Controller
- For Continental Solid State AM Transmitters
- Programmable Functions for 12 Months in advance
 - Power On/Power Off
 - Power Up/Power Down (low power at sunset)
 - Phasor Pattern Changes
- Provides Data storage for all Pre-Failure and Fault conditions by milliseconds, seconds, minutes, hours, day, and month for trend tracing
- Read-out of Basic Transmitter Metering:
 - PA Voltage
 - PA Current
 - Forward Power
 - Reflected Power
 - Common Point Current
 - Phase Angle/Loop Current
 - 3-Phase AC Voltages
 - Inlet/Outlet Temperature
 - Room Temperature
- Read-out of Transmitter Status:
 - PA ON/OFF
 - Air Flow OK
 - Power Control: AUTO/MANUAL
 - REMOTE/LOCAL
- Remote Output to Modem for External PC Interface
- Automatic Log Printing (with optional printer)
 - Logs stored automatically by hour, day, and month
- Data stored in Non-Volatile Memory for CRT viewing at any time
- User Defined:
 - Limits and Alarms for Selected Parameters
 - External Equipment Control
 - External Equipment Monitoring/Status
 - A/D Channels for External Uses P/N 160433-1



AM extended meter panel

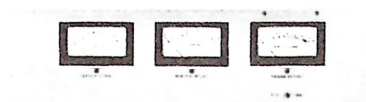

FM extended meter panel

AM and FM Transmitter Extended Meter Panels

AM and FM transmitter extended meter panels can be provided for the situation where the operator can view the transmitter but is too far removed to be able to read critical meters. The AM transmitter meter panel provides meters for plate voltage, plate current, and power output with provisions also for reading reflected power. All panels are the rack-mounting type.

Size:
48.3 cm (19") W
13.3 cm (5 1/4") H
13.9 cm (5 1/2") D
Weight:
2.27 kg (5 lb)



P/N 142289 Envelope Demodulator

Continental's Envelope Demodulator removes the RF from transmitter sample and provides for an accurate audio signal for measuring distortion and audio. RF input is routed back thru a rear BNC connector. Designed for use with Continental Type 317C 50,000 and 316F 10,000 watt AM transmitters, the unit can be adapted for other transmitters.

Technical Characteristics

Power required: 100-130 vac, 0.25 a,
50/60 Hz RF input level required: 70v max,
peak-to-peak, unmodulated
Audio monitor output: ac coupled
Distortion measurement: BNC connector,
front panel
Size: 19" wide, 2" high, 6" deep, 18 lbs.

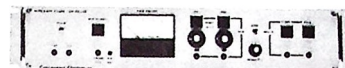

P/N 142340 Automatic Power Controller

Continental's Automatic Power Controller corrects for line voltage changes by automatically raising or lowering power amplifier plate and screen voltage, using variable transformers already in the transmitter. Circuit sensitivity is adjustable so that plate voltage variations due to modulation will not cause a continual "hunting" condition. Designed for use with Continental's 317C 50,000 watt AM transmitters.

Technical Characteristics

Power required:
100-130 vac, 50/60 Hz
Size: 19" wide, 3-1/2" high, 8" deep, 16 lbs.



P/N 142288 Battery Power Supply

Continental's rechargeable 12-volt Battery Power Supply provides low voltage for controlling relays, interlocks and overload status lights of a broadcast transmitter in the event of a main power loss. It's designed for use with Continental's 317C-2 50,000 watt AM transmitters.

Technical Characteristics

Battery: 12 vdc, Ampere/hours 4.5, Charging rate 0 to 2.0 amperes
Charger: 12 vdc, Fast charges @ 2.0 amperes, Trickle charge @ 0.5 amperes
Charger power requirements:
100-130 vac, 50/60 Hz
Size: 19" wide, 4" high, 7" deep

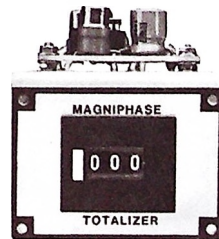

P/N 142407 Magniphase Totalizer

Continental's Magniphase Totalizer automatically records Magniphase trips; has resettable counter. Designed for use on Continental Type 317C 50,000 and 316F 10,000 watt AM transmitters, unit mounts on transmitter front; can be adapted to other transmitters using Magniphase.

Technical Characteristics

Power required; 100-130 vacs, 50/60 Hz
Size: 2-1/4" wide, 2-1/2" high, 3-1/2" deep, 1 lb

All specifications are subject to change without notice.

Antenna Systems

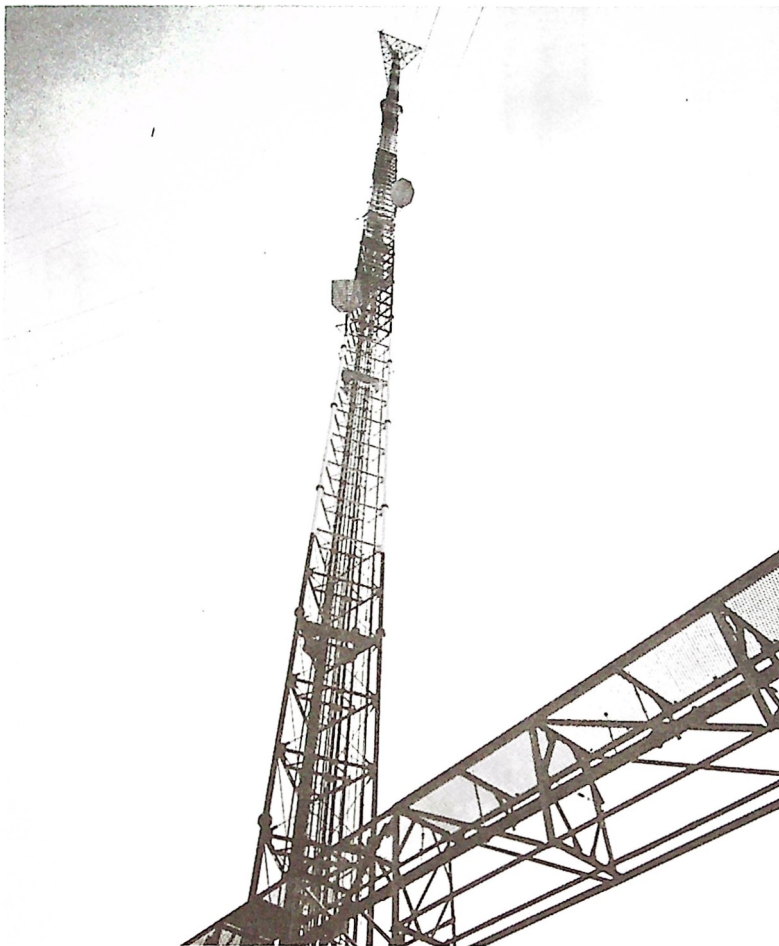

Introduction

Continental offers broadcasters a complete antenna system service, including manufacturing, testing, and field supervision of directional or omni-directional AM and FM antennas; AM and FM towers; antenna phasing and coupling systems and related antenna system equipment.

AM & FM Towers

Continental can supply a variety of self-supporting and guyed antenna towers, custom design to meet specific AM or FM station requirements.

Towers are normally supplied with a protective coating of rust inhibitive paint prior to shipment; they can be supplied with a galvanized finish.

All hardware, fittings, guy insulators, anchor steel and base insulator are supplied with each tower. Appropriate tower lighting kits to meet FCC/FAA or ICAO requirements, are also available; see "Antenna System Accessories".

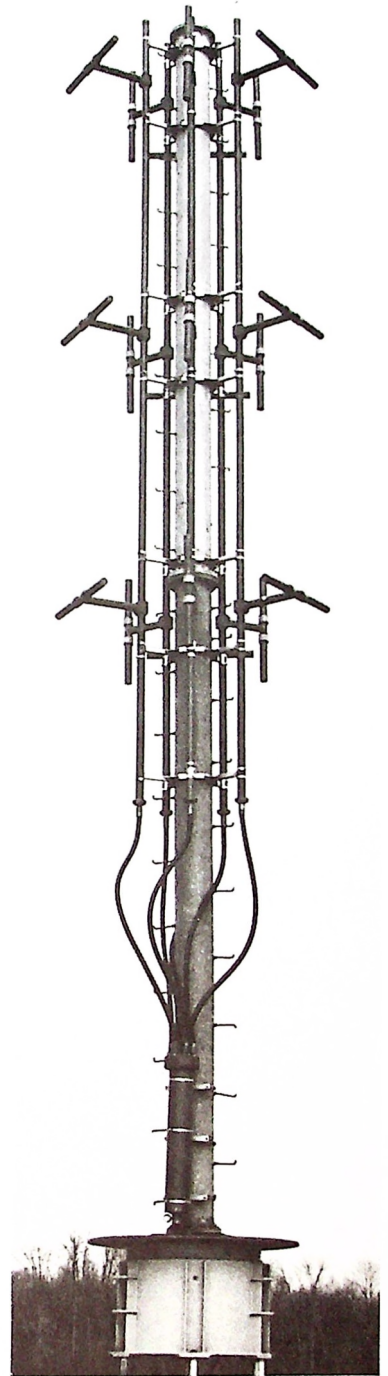

Antenna Phasing & Coupling

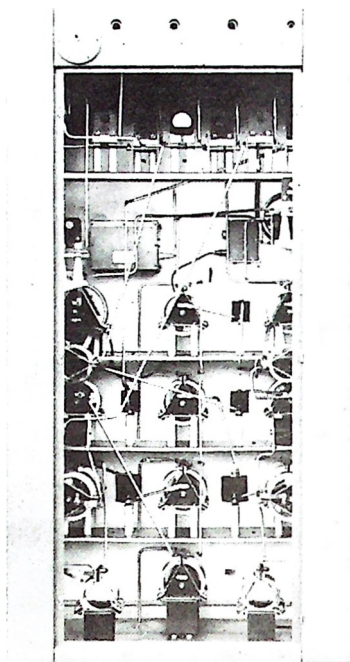

Continental "Wideband" phaser

Continental engineers have developed a technique that optimizes the impedance and pattern bandwidths of a phased array.

Following is an overview of this technology.

After completion of the initial phaser design, the sideband self and mutual impedances are calculated, based on electromagnetic propagation less than the speed of light.

Because sideband parameters are frequency

Continental Electronics AM Antenna Couplers

Standard antenna couplers are available in panel-mount and weatherproof housing configurations, for use with Continental 1 kW, 5 kW and 10 kW AM transmitters.

Panel mount couplers come with fully adjustable tee network, input jack, static drain choke, Delta RF ammeter. Tower lighting choke must be ordered as separate item.

Weatherproof couplers come with fully adjustable tee network, input jack, static drain choke, Delta RF ammeter. All components come in weatherproof housing. Tower lighting choke must be ordered as separate item.

Ordering Information

Panel Mount Coupler:

1 kW, Type 514AT-1P

5 kW, Type 515AT-1P

10 kW, Type 516AT-1P

Weatherproof Coupler:

1 kW, Type 514AT-1WP

5 kW, Type 515AT-1WP

10 kW, Type 516AT-1WP

dependent, different tower electrical heights and spacings exist from those specified for the carrier frequency.

Then, three network models of the towers are calculated: one at carrier, and one at each sideband. The components of each network are placed in the phaser topology, and the whole system is then analyzed by a computer program using admittance matrix algebra. Component reactances and transmission line lengths are automatically adjusted for frequency. The effects of coil Q and transmission line loss are included.

The frequency-sensitive tower impedance model answers two questions which cannot be answered if the tower system's current ratios or operating impedances are assumed to be constant. They are:

- (1) Tower currents at the sidebands.
- (2) Tower currents at the carrier during the adjustment process.

Obtaining the common-point impedance, VSWR and the tower currents, and the effect each component has on these parameters, enables Continental engineers to prepare an optimum system design. In addition to "widebanding", this technique can be used to study adjustment sensitivity at carrier. It can also be used to give advance indication when a power divider control is more of a phase control and vice-versa. Adjustment interaction can be optimized during the design process.

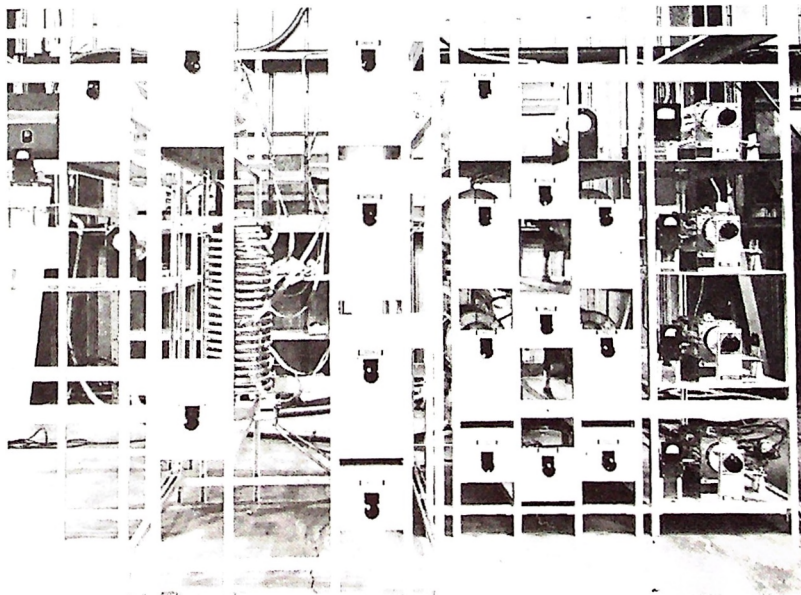
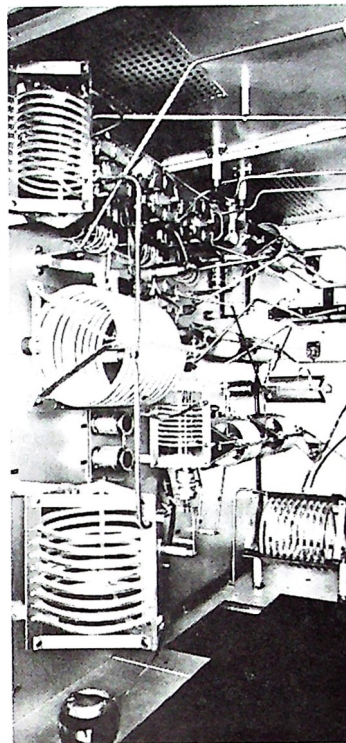

G5CPS FM Antenna

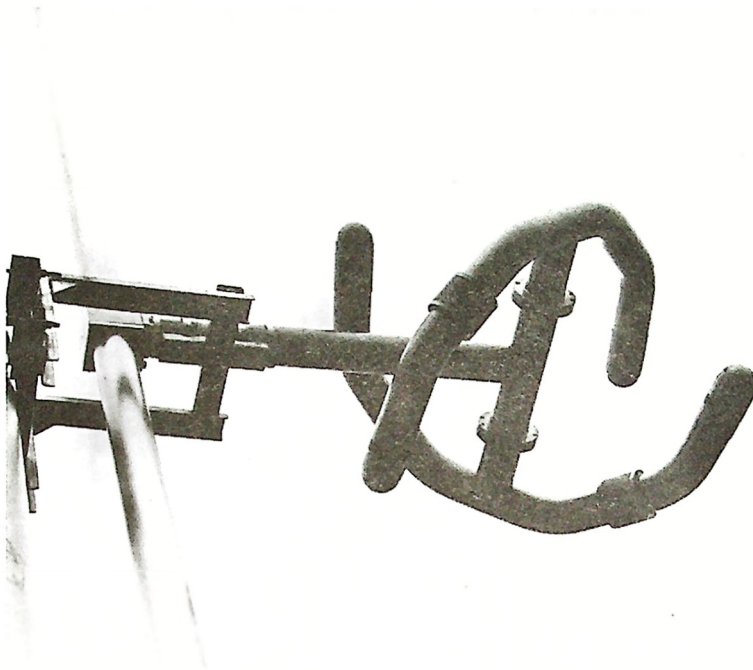

G5CPS Super Power Circularly Polarized FM Antenna

The brass radiating element has an outside diameter of 3-1/8". The feed point is completely internal with a pressurized environment up to the feed point.

The radiating element is rated at 40 kW, and is limited by the safe average power capability of the 3-1/8 rigid coax line.

The heavy-wall brass tubing stem can withstand harsh environmental conditions.

Deicers are not recommended in moderate environments because typical VSWR is 1.5:1 or less with 1/2" of radial ice, if the antenna has been field tuned. Heaters for deicers or radomes are available.

All G5CPS antennas use silver-plated inner conductor connectors throughout to reduce losses and heating. Each antenna, supplied with a 6 foot input matching section has 50-ohm

EIA input. Depending on model type, the input is either a 3-1/8 inch 50 ohm EIA female input or a 6-1/8 inch 50 ohm EIA female input.

Once each antenna is completely assembled and factory-tuned to the customer's frequency, it is pressure tested at 10 lbs. pressure for one hour to ensure that the antenna is leak-free prior to shipment.

The antenna system feed point is 6 feet below the bottom bay for end fed antennas, and approximately 6 feet below the center of the antenna for center fed antenna systems.

The horizontally polarized horizontal-plane radiation pattern is omnidirectional when pole-mounted atop a tower; a ± 2 dB circularity is typical when mounted on a 14 inch diameter steel pole. When side-mounted on a tower, the antenna pattern will be affected by the tower structure.

Complete antenna pattern measurement services are available on a quotation basis. Horizontal plane relative field patterns are measured on a full scale mock up of a 20 foot section of the customer's tower, including the ladder, coaxial transmission lines, conduits, cables and antenna element. Pattern optimization for both horizontal and vertical polarization is available for improving the pattern circularity of the antenna-support tower combination. Precision model studies are also available for situations where larger vertical apertures of the array need to be analyzed.

The G5CPS has a low standing-wave ratio of 1.07:1, or less, ± 200 KHz for a given channel with field trimming. The VSWR at antenna input without field trimming is 1.2:1 for pole mounting atop a tower; 1.5:1 or less when side mounted on a tower.

Multistation operation is possible using a common antenna system due to the excellent bandwidth characteristics of the G5 antenna design. Continental can quote filtering components required for the diplexing or multiplexing operation. Stations with a frequency separation as large as 4 MHz can be diplexed on a common antenna.

SPECIFICATIONS

Frequency Range:

88 to 108 MHz, factory tuned to one frequency

Polarization:

Circular (clockwise)

Power Gain:

See tables

Azimuthal Pattern:

± 2 dB in free space, both horizontal and vertical

Ellipticity:

± 3 dB in free space

VSWR at Input (without field tuning):

1.2:1 pole mounting,
1.5:1 or better side mounting

VSWR at input (with field tuning):

1.1:1 or better

(see tables for rest of specifications)

All specifications are subject to change without notice.

G5CPS FM Antenna

Series A: 3-1/8" Interbay Line; 3-1/8" Element Stem

No. of Bays	Power Gain	dB Gain	Type Feed	Element 50 Ohm Input	Power ¹ Input	Wt. ² In Lbs.	W.L. ³ In Lbs.	Wt. ⁴ In Lbs.	W.L. ⁵ In Lbs.	Approx. ⁶ Length In Feet
1	0.4611	-3.3623	End	3-1/8"	32 kW	114	137	185	354	--
2	0.9971	-0.0128	End	3-1/8"	32 kW	225	304	376	742	10
2	0.9971	-0.0128	Center	3-1/8"	39 kW	250	319	385	749	10
2	0.9971	-0.0128	Center	6-1/8"	64 kW	301	421	436	851	10
3	1.5588	1.9278	End	3-1/8"	32 kW	336	470	568	1130	20
3	1.5588	1.9278	Center	3-1/8"	39 kW	361	486	577	1136	20
3	1.5588	1.9278	Center	6-1/8"	64 kW	412	588	628	1240	20
4	2.1332	3.2903	End	3-1/8"	32 kW	447	637	759	1518	30
4	2.1332	3.2903	Center	3-1/8"	39 kW	472	652	768	1525	30
4	2.1332	3.2903	Center	6-1/8"	64 kW	523	758	819	1631	30
5	2.7154	4.3384	End	3-1/8"	32 kW	558	804	951	1905	40
5	2.7154	4.3384	Center	3-1/8"	39 kW	583	819	960	1911	40
5	2.7154	4.3384	Center	6-1/8"	64 kW	634	927	1011	2011	40
6	3.3028	5.1888	End	3-1/8"	32 kW	669	971	1142	2294	50
6	3.3028	5.1888	Center	3-1/8"	39 kW	694	986	1151	2300	50
6	3.3028	5.1888	Center	6-1/8"	64 kW	745	1096	1202	2410	50
7	3.8935	5.9034	End	3-1/8"	32 kW	780	1138	1334	2682	60
7	3.8935	5.9034	Center	3-1/8"	39 kW	805	1153	1343	2688	60
7	3.8935	5.9034	Center	6-1/8"	64 kW	856	1265	1394	2800	60
8	4.4872	6.5197	End	3-1/8"	32 kW	891	1305	1525	3070	70
8	4.4872	6.5197	Center	3-1/8"	39 kW	916	1320	1534	3076	70
8	4.4872	6.5197	Center	6-1/8"	64 kW	967	1433	1585	3190	70
9	5.0825	7.0608	Center	3-1/8"	38 kW	1027	1487	1725	3464	80
9	5.0825	7.0608	Center	6-1/8"	64 kW	1078	1600	1776	3580	80
10	5.6800	7.5435	Center	3-1/8"	39 kW	1138	1653	1917	3852	90
10	5.6800	7.5435	Center	6-1/8"	64 kW	1189	1770	1968	3970	90
11	6.2783	7.9784	Center	3-1/8"	39 kW	1249	1820	2108	4240	100
11	6.2783	7.9784	Center	6-1/8"	64 kW	1300	1940	2159	4360	100
12	6.8781	8.3747	Center	3-1/8"	39 kW	1360	1987	2300	4628	110
12	6.8781	8.3747	Center	6-1/8"	64 kW	1411	2108	2351	4750	110

Series B: 4-1/8" Interbay Line; 4-1/8" Element Stem

1	0.4611	-3.3623	End	6-1/8"	40 kW	159	201	223	421	--
2	0.9971	-0.0128	End	6-1/8"	56 kW	297	407	425	847	10
2	0.9971	-0.0128	Center	6-1/8"	80 kW	336	468	464	908	10
3	1.5588	1.9278	End	6-1/8"	56 kW	435	613	627	1273	20
3	1.5588	1.9278	Center	6-1/8"	112 kW	474	674	666	1337	20
4	2.1332	3.2903	End	6-1/8"	56 kW	573	818	829	1699	30
4	2.1332	3.2903	Center	6-1/8"	112 kW	612	879	869	1762	30
5	2.7154	4.3384	End	6-1/8"	56 kW	711	1024	1031	2125	40
5	2.7154	4.3384	Center	6-1/8"	112 kW	750	1085	1070	2187	40
6	3.3028	5.1888	End	6-1/8"	56 kW	849	1229	1233	2551	50
6	3.3028	5.1888	Center	6-1/8"	112 kW	888	1290	1272	2612	50
7	3.8935	5.9034	End	6-1/8"	56 kW	987	1435	1435	2997	60
7	3.8935	5.9034	Center	6-1/8"	112 kW	1026	1496	1474	3037	60
8	4.4872	6.5197	End	6-1/8"	56 kW	1125	1641	1637	3043	70
8	4.4872	6.5197	Center	6-1/8"	112 kW	1164	1702	1676	3462	70
9	5.0825	7.0608	Center	6-1/8"	112 kW	1302	1907	1878	3887	80
10	5.6800	7.5435	Center	6-1/8"	112 kW	1440	2113	2080	4312	90
11	6.2783	7.9784	Center	6-1/8"	112 kW	1578	2318	2282	4737	100
12	6.8781	8.3747	Center	6-1/8"	112 kW	1716	2524	2484	5162	110

Series C: 6-1/8" Interbay Line; 4-1/8" Element Stem

1	0.4611	-3.3623	End	6-1/8"	40 kW	205	260	269	480	--
2	0.9971	-0.0128	End	6-1/8"	80 kW	410	520	538	960	10
3	1.5588	1.9278	End	6-1/8"	120 kW	615	780	807	1440	20
4	2.1332	3.2903	End	6-1/8"	120 kW	820	1040	1076	1920	30
5	2.7154	4.3384	End	6-1/8"	120 kW	1025	1300	1345	2400	40
6	3.3028	5.1888	End	6-1/8"	120 kW	1230	1560	1614	2880	50

(1) Power input capability is shown for altitudes up to 2000 feet above mean sea level; derating is required above 2000 feet. (2) Calculated weight, including brackets. (3) Calculated wind load including brackets, based on 50/33 Lb/Lsq Ft. (4) Calculated weight with Radome and brackets. (5) Calculated wind load with Radome and brackets, based on 50/33 Lb/Lsq Ft. (6) End feed antenna lengths do not include 6-ft matching transformer.

G8CPS FM Antenna



G8CPS Super Power Circularly Polarized FM Antenna

Similar to the G5CPS antenna, the G8 antenna is designed to achieve maximum circularity of coverage, especially when mounted on tower sections having a 24-inch face dimension.

Tables show the most popular models. Other standard models are available.

For information, contact your local Continental Electronics Sales Manager.

SPECIFICATIONS

Frequency Range:
88 to 108 MHz, factory tuned to one frequency

Polarization:

Circular (clockwise)

Power Gain:

See tables

Azimuthal Pattern:

±2 dB in free space, both horizontal and vertical

Ellipticity:

±3 dB in free space

VSWR at Input, Without Field Tuning:

1.25:1 pole mounting

1.5:1 or better, side mounting

VSWR at Input, With Field Tuning:

1.1:1 or better

(See tables for other specifications)

Series A: 3-1/8" Interbay Line; 3-1/8" Element Stem

No. of Bays	Power Gain	dB Gain	Type Feed	Female 50 Ohm Input	Power Input ³	Wt. ^A (Lbs)	W.L. ^B (Lbs)	Wt. ^C (Lbs)	W.L. ^D (Lbs)	Approx. Length ² (Feet)
1	0.4611	-3.3623	End	3-1/8"	32 kW	114	137	167.5	387	
2	0.9971	-0.0128	End	3-1/8"	32 kW	225	304	341	808	10
2	0.9971	-0.0128	Center	3-1/8"	39 kW	250	319	350	815	10
3	1.5588	1.9278	End	3-1/8"	32 kW	336	470	515.5	1228	20
4	2.1332	3.2903	End	3-1/8"	32 kW	447	637	689	1649	30
4	2.1332	3.2903	Center	3-1/8"	39 kW	472	652	698	1656	30
4	2.1332	3.2903	Center	6-1/8"	64 kW	523	758	749	1770	30
5	2.7154	4.3384	End	3-1/8"	32 kW	558	804	863.5	2069	40
6	3.3028	5.1888	End	3-1/8"	32 kW	669	971	1037	2491	50
6	3.3028	5.1888	Center	3-1/8"	39 kW	694	986	1046	2497	50
6	3.3028	5.1888	Center	6-1/8"	64 kW	745	1096	1097	2614	50
7	3.8935	5.9034	End	3-1/8"	32 kW	780	1138	1211.5	2912	60
8	4.4872	6.5197	End	3-1/8"	32 kW	891	1305	1385	3332	70
8	4.4872	6.5197	Center	3-1/8"	39 kW	916	1320	1394	3338	70
8	4.4872	6.5197	Center	6-1/8"	64 kW	967	1433	1445	3457	70
10	5.6800	7.5435	Center	3-1/8"	39 kW	1138	1653	1742	4180	90
10	5.6800	7.5435	Center	6-1/8"	64 kW	1189	1770	1793	4300	90
12	6.8781	8.3747	Center	3-1/8"	39 kW	1360	1987	2090	5022	110
12	6.8781	8.3747	Center	6-1/8"	64 kW	1411	2108	2141	5144	110

Series B; 4-1/8" Interbay Line; 4-1/8" Element Stem

1	0.4611	-3.3623	End	6-1/8"	40 kW	159	201	206	454	
2	0.9971	-0.0128	End	6-1/8"	56 kW	297	407	393	913	10
2	0.9971	-0.0128	Center	6-1/8"	80 kW	336	468	432	974	10
3	1.5588	1.9278	End	6-1/8"	56 kW	435	613	579	1119	20
4	2.1332	3.2903	End	6-1/8"	56 kW	573	818	765	1830	30
4	2.1332	3.2903	Center	6-1/8"	112 kW	612	879	804	1891	30
5	2.7154	4.3384	End	6-1/8"	56 kW	711	1024	951	2289	40
6	3.3028	5.1888	End	6-1/8"	56 kW	849	1229	1137	2747	50
6	3.3028	5.1888	Center	6-1/8"	112 kW	888	1290	1176	2808	50
7	3.8935	5.9034	End	6-1/8"	56 kW	987	1435	1323	3206	60
8	4.4872	6.5197	End	6-1/8"	56 kW	1125	1641	1509	3665	70
8	4.4872	6.5197	Center	6-1/8"	112 kW	1164	1702	1548	3762	70
10	5.6800	7.5435	Center	6-1/8"	112 kW	1440	2113	1920	4643	90
12	6.8781	8.3747	Center	6-1/8"	112 kW	1716	2524	2292	5560	110

Series C: 6-1/8" Interbay Line; 4-1/8" Element Stem

1	0.4611	-3.3623	End	6-1/8"	40 kW	205	260	253	513	
2	0.9971	-0.0128	End	6-1/8"	80 kW	410	520	506	1026	10
3	1.5588	1.9278	End	6-1/8"	120 kW	615	780	759	1539	20
4	2.1332	3.2903	End	6-1/8"	120 kW	820	1040	1012	2052	30
5	2.7154	4.3384	End	6-1/8"	120 kW	1025	1300	1265	2565	40
6	3.3028	5.1888	End	6-1/8"	120 kW	1230	1560	1518	3078	50

NOTES: (A) = Calculated weight, including brackets (B) = Calculated wind load, including brackets (C) = Calculated weight with Radome & brackets (D) = Calculated wind load with Radome & brackets (1) Wind load is based on 50/33 PSF. (2) End feed antenna lengths do not include 6-ft matching transformer. (3) Power input capability is shown for altitudes up to 2000 feet above mean sea level; derating is required above 2000 feet.

G6 FM Antenna

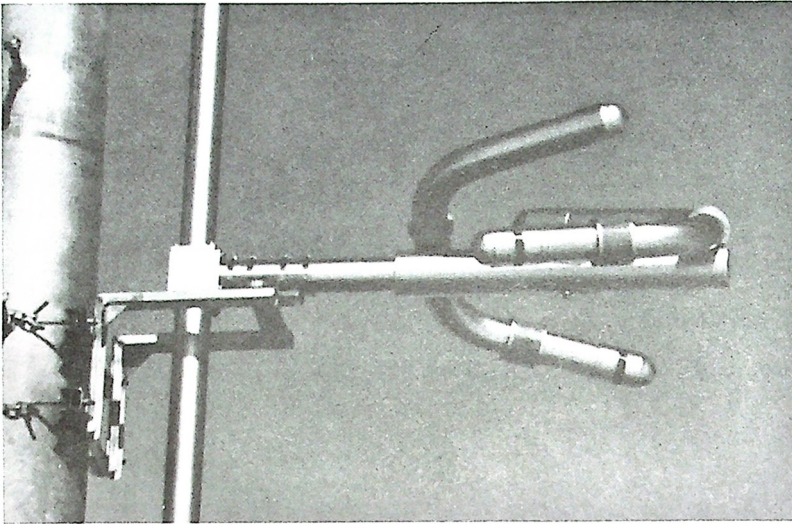

G6 Circularly Polarized Sidemount FM Antenna

Continental's G6 antenna is similar in construction to the G4CPL Series antenna.

The G6 offers exceptional axial ratio and free-space pattern circularity, and is an ideal antenna for applications where fringe area coverage is important.

The radiating element is constructed of brass and has an outside diameter of 3-1/8". The internal feed system is contained within a pressurized environment. Each element has an internal dc short which eliminates the need for a quarterwave stub.

The G6 is available in two versions: E and C.

The E version is end fed, the C version is center fed. Both versions have 3-1/8", 50 ohm,

EIA standard female flanged input connections.

Each G6 antenna system is completely assembled, tuned to customer-specified frequency and pressure-tested at the factory prior to shipping to the customer's site.

Deicers are available as an extra-cost, factory-installed option, and must be specified at the time the order is placed. Deicers add approximately 15 lbs per bay to antenna weight.

Anti rotation brackets are recommended for leg-mounted systems on towers having legs which are 3" or less in diameter.

Antenna Overview

- All stainless steel hardware
- Pressurized internal feed system
- DC grounded input
- Helicarced rigid base construction

SPECIFICATIONS

Frequency range:

88 to 108 MHz; factory tuned to one frequency

Polarization:

Circular (clockwise)

Power gain:

See tables below

Azimuthal pattern:

± 2 dB in free space, horizontally or vertically

Ellipticity:

± 3 dB or better in free space

VSWR at input with field tuning:

1.07 : 1 for $f_0 \pm 100$ kHz

1.15 : 1 for $f_0 \pm 200$ kHz

Antenna Type	Power Gain	DB Gain	Type Feed	Power Input ² Capability (kW)	Calculated Weight (lbs)	Calculated Windload ¹ (lbs)
G6-1AE	.4611	-3.3623	End	10	108	176.4
G6-2AE	.9971	-0.0128	End	20	225	382.5
G6-2AC	.9971	-0.0128	Center	20	243	405.7
G6-3AE	1.5588	1.9278	End	30	342	588.6
G6-4AE	2.1332	3.2903	End	32	459	794.7
G6-4AC	2.1332	3.2903	Center	39	477	817.9
G6-5AE	2.7154	4.3384	End	32	576	1000.8
G6-6AE	3.3028	5.1888	End	32	693	1206.9
G6-6AC	3.3028	5.1888	Center	39	711	1230.1
G6-7AE	3.8935	5.9034	End	32	810	1413.0
G6-8AE	4.4872	6.5197	End	32	927	1619.1
G6-8AC	4.4872	6.5197	Center	39	945	1642.3
G6-10AC	5.6800	7.5435	Center	39	1179	2054.5
G6-12AC	6.8781	8.3747	Center	39	1413	2466.7
G6-14AC	8.0798	9.0740	Center	39	1647	2878.9

Notes: (1) Power input capability up to 2,000 ft. above mean sea level. Derating required above 2,000 ft. (2) Windload calculated based on 50/33 psf, 112 mph actual wind velocity. (3) Weight and windload calculations include brackets. (4) All antenna systems have 50 ohm female inputs.

All specifications subject to change without notice.

G5CPM FM Antenna

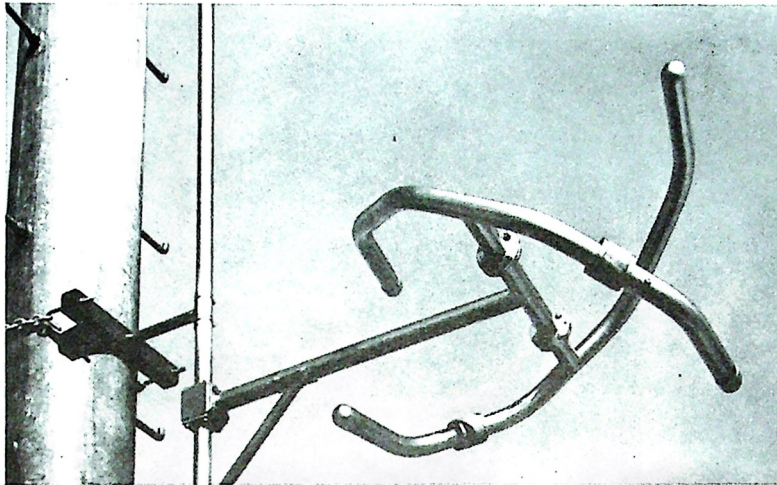

The radiating element is rated at 9 kW, and is limited by the safe average power capability of the 1-5/8" rigid coax line.

The heavy-wall brass tubing stem can withstand harsh environmental conditions, winds up to 125 mph, and moderate ice loads.

Radomes and deicers are available. The typical VSWR with 1/3" radial ice is 1.5:1 or less, if the antenna has been field tuned.

SPECIFICATIONS

Frequency Range:

88 to 108 MHz, factory tuned to one frequency

Polarization:

Circular (clockwise)

Power Gain:

See tables

Azimuthal Pattern:

±2 dB in free space, both horizontal and vertical

Ellipticity:

±3 dB in free space

VSWR at Input (without field tuning):

1.2:1 pole mounting, 1.5:1 or better side mounting

VSWR at Input (with field tuning):

1.1:1 or better (see tables for rest of specifications)

G5CPM Medium Power Circularly Polarized FM Antenna

The G5CPM offers broadcasters the advantages and benefits of a super power antenna in a medium power size.

The heavy-duty brass radiating element has an outside diameter of 1-3/4". The internal feed point is pressurized up to the feed point. Inner conductors are constructed to reduce losses and heating.

No. of Bays	Power Gain	dB Gain	Type Feed	Female 50 Ohm Input	Power Input	Wt. ^A (Lbs)	W.L. ^B (Lbs)	Wt. ^C (Lbs)	W.L. ^D (Lbs)	Approx. Length ⁴ (Feet)
1	0.4611	-3.3623	End	1-5/8"	9 kW	57	102	83	224	
2	0.9971	-0.0128	End	1-5/8"	9 kW	114	212	166	457	10
2	0.9971	-0.0128	Center	3-1/8"	12 kW	152	302	199	533	10
3	1.5588	1.9278	End	1-5/8"	9 kW	170	323	248	689	20
3	1.5588	1.9278	Center	3-1/8"	12 kW	207	412	282	766	20
4	2.1332	3.2903	End	1-5/8"	9 kW	227	433	331	922	30
4	2.1332	3.2903	Center	3-1/8"	12 kW	260	509	364	998	30
5	2.7154	4.3384	End	1-5/8"	9 kW	283	543	413	1154	40
5	2.7154	4.3384	Center	3-1/8"	12 kW	317	620	447	1231	
6	3.3028	5.1888	End	1-5/8"	9 kW	340	654	496	1387	50
6	3.3028	5.1888	Center	3-1/8"	12 kW	373	730	529	1463	50
7	3.8935	5.9034	End	1-5/8"	9 kW	396	764	578	1619	60
7	3.8935	5.9034	Center	3-1/8"	12 kW	430	840	612	1696	60
8	4.4872	6.5197	End	1-5/8"	9 kW	453	874	661	1852	70
8	4.4872	6.5197	Center	3-1/8"	12 kW	486	960	694	1928	70
9	5.0826	7.0608	Center	3-1/8"	12 kW	543	1060	777	2160	80
10	5.6800	7.5435	Center	3-1/8"	12 kW	599	1171	859	2393	90
11	6.2783	7.9785	Center	3-1/8"	12 kW	656	1281	942	2626	100
12	6.8781	8.3747	Center	3-1/8"	12 kW	712	1391	1024	2858	110

NOTES: (A) = Calculated weight, including brackets (B) = Calculated wind load, including brackets (C) = Calculated weight with Radome & brackets (D) = Calculated wind load with Radome & brackets (1) Wind load is based on 50/33 PSF. (2) Power split is 50/50 vertical and horizontal only. Beam tilt and null fill are available as extra cost options on center fed antennas, but will change the gain figures given above and may reduce the power rating. (3) End feeding is done with a 6-ft matching transformer section. Center feeding of an odd number of bays is done at a point one-half bay below the center of the antenna. The 6-ft matching transformer is connected to an elbow at the center feed point and extends downward. (4) End feed antenna lengths do not include 6-ft matching transformer. (5) Power input capability is shown for altitudes up to 2000 feet above mean sea level; derating is required above 2000 feet.

All specifications are subject to change without notice.

G4CPH & G4CPL FM Antennas

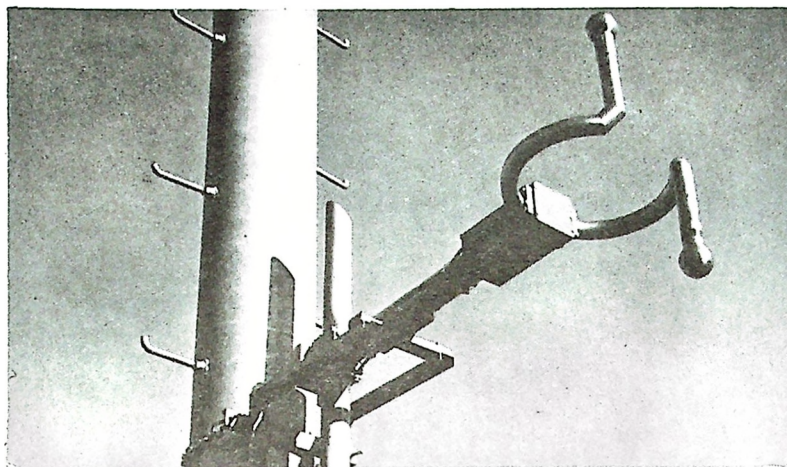

Factory-installed deicers are available in powers of 300 and 500 watts per bay. Specify 120- or 230-volt operation when ordering. Shielded interbay heater cable and junction boxes are supplied as a part of the heater system. Heater weight, including junction boxes and cable, is 7 lb. per bay. Heaters are field replaceable.

Special power splits, other than 50/50 (vertical and horizontal), beam tilt and/or null fill are available at extra cost.

Radomes are also available to reduce the effect of ice on the VSWR of the antenna.

SPECIFICATIONS

Frequency Range:

88 to 108 MHz, factory tuned to one frequency

Polarization:

Circular (clockwise)

Power Gain:

See tables

Azimuthal Pattern:

±2 dB in free space, both horizontal and vertical

Ellipticity:

±3 dB in free space

VSWR at Input (without field tuning):

1.25:1 pole mounting, 1.5:1 or better side mounting

VSWR at Input (with field tuning):

1.1:1 or better

(see tables for rest of specifications)

All specifications are subject to change without notice.

G4CPH High Power Circularly Polarized FM Antenna

The G4CPH is a rugged, heavy-duty design capable of handling powers from 5 kW (single bay) to 40 kW (eight or more bays). The antenna may be purchased in any number of bays from 1 to 16. The antennas are end fed in combinations from one to eight bays. In center fed antenna arrays, the center fed "T" input is located one half bay spacing below the center of the array if the array consists of an odd number of bays.

Antennas of one to eight bays are end fed with a 6 foot matching section connected to the bottom bay.

The rings of the antenna are mounted on 3-1/8" transmission line with a 3-1/8" input flange on standard antennas. Antennas that are to have 40 kW input are provided with a 6-1/8" flange and center feed block (at extra cost). 3" diameter Corona balls are provided at the outer extremity of the arms of each bay of the antenna. The antenna is designed to withstand wind velocities to 150 miles per hour.

Type	Power Gain		dB Gain		Field Gain		Input Power Rating kW	Approx Length (m) ft	Weight (Including Brackets) (kg) lb	Wind Load Based on 244/161	Weight (With Radomes Incl. Brackets) (kg) lb	Wind Load With Radomes Based on 244/161
	Horiz	Vert	Horiz	Vert	Horiz	Vert				kg/sq.m (50/33 lb/sq ft)		kg/sq.m (50/33 lb/sq ft)
G4CPH-1	0.4611	0.4611	-3.3623	-3.3623	0.6790	0.6790	5.0	—	(38) 84	(65) 144	(47) 104	(120) 265
G4CPH-2	0.9971	0.9971	-0.0128	-0.0128	0.9985	0.9985	10	(3) 10	(83) 184	(144) 318	(102) 224	(254) 560
G4CPH-3	1.5588	1.5588	1.9278	1.9278	1.2485	1.2485	15	(6) 20	(124) 274	(223) 492	(152) 334	(388) 855
G4CPH-4	2.1332	2.1332	3.2903	3.2903	1.4605	1.4605	20	(9) 30	(165) 364	(302) 666	(201) 444	(522) 1150
G4CPH-5	2.7154	2.7154	4.3384	4.3384	1.6478	1.6478	25	(12) 40	(206) 454	(381) 840	(251) 554	(655) 1445
G4CPH-6	3.3028	3.3028	5.1888	5.1888	1.8174	1.8174	30	(15) 50	(247) 544	(460) 1014	(301) 664	(789) 1740
G4CPH-7	3.8935	3.8935	5.9034	5.9034	1.9732	1.9732	35	(18) 60	(288) 634	(538) 1187	(351) 774	(923) 2034
G4CPH-8	4.4872	4.4872	6.5197	6.5197	2.1183	2.1183	40	(21) 70	(328) 724	(617) 1361	(401) 884	(1056) 2329
G4CPH-9	5.0826	5.0826	7.0608	7.0608	2.2545	2.2545	40	(24) 80	(379) 835	(729) 1608	(460) 1015	(1223) 2697
G4CPH-10	5.6800	5.6800	7.5435	7.5435	2.3833	2.3833	40	(27) 90	(420) 925	(808) 1782	(510) 1125	(1357) 2992
G4CPH-11	6.2783	6.2783	7.9785	7.9785	2.5057	2.5057	40	(30) 100	(460) 1015	(887) 1956	(560) 1235	(1491) 3287
G4CPH-12	6.8781	6.8781	8.3747	8.3747	2.6226	2.6226	40	(34) 110	(501) 1105	(966) 2130	(610) 1345	(1625) 3582
G4CPH-13	7.4785	7.4785	8.7381	8.7381	2.7347	2.7347	40	(37) 120	(542) 1195	(1045) 2303	(660) 1455	(1758) 3876
G4CPH-14	8.0800	8.0800	9.0741	9.0741	2.8425	2.8425	40	(40) 130	(583) 1285	(1124) 2477	(710) 1565	(1892) 4171
G4CPH-15	8.6818	8.6818	9.3861	9.3861	2.9465	2.9465	40	(43) 140	(624) 1375	(1202) 2651	(760) 1675	(2026) 4466
G4CPH-16	9.2846	9.2846	9.6776	9.6776	3.0471	3.0471	40	(46) 150	(665) 1465	(1281) 2825	(810) 1785	(2160) 4761
G4CPL-1	0.4611	0.4611	-3.3623	-3.3623	0.6790	0.6790	3	—	(16) 36	(34) 74	(24) 54	(73) 161
G4CPL-2	0.9971	0.9971	-0.0128	-0.0128	0.9985	0.9985	6	(3) 10	(35) 77	(47) 104	(52) 115	(153) 338
G4CPL-3	1.5588	1.5588	1.9278	1.9278	1.2485	1.2485	7.5	(6) 20	(54) 118	(115) 254	(78) 172	(234) 515
G4CPL-4	2.1332	2.1332	3.2903	3.2903	1.4605	1.4605	7.5	(10) 30	(72) 159	(156) 344	(105) 231	(314) 693
G4CPL-5	2.7154	2.7154	4.3384	4.3384	1.6478	1.6478	7.5	(12) 40	(91) 200	(197) 434	(132) 290	(385) 870
G4CPL-6	3.3028	3.3028	5.1888	5.1888	1.8174	1.8174	7.5	(15) 50	(109) 241	(238) 524	(158) 349	(475) 1047
G4CPL-7	3.8935	3.8935	5.9034	5.9034	1.9732	1.9732	7.5	(18) 60	(128) 282	(279) 614	(185) 408	(555) 1224
G4CPL-8	4.4872	4.4872	6.5197	6.5197	2.1183	2.1183	7.5	(21) 70	(147) 323	(319) 704	(212) 467	(636) 1402

All antenna brackets are stainless steel. All weights given include brackets, interbay line, and transformer section. Factory-installed deicers are available using either 300 watts or 500 watts per bay. Specify 120 or 230 volts. Heater elements are replaceable in the field. Shielded interbay heater cable and junction boxes are supplied. Heater weight, including junction boxes and interbay cable, is 6 lb (2.7 kg) additional per bay.

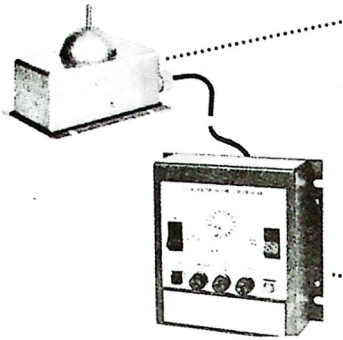

Ice Warning System

The Rosemount ice warning system consists of a controller and an ice detector*.

Most ice warning and heater control systems are operated by a thermostat device; thus, antenna heaters are energized whenever the temperature drops below approximately 35°F (1.7°C). Statistically, the probability of icing seldom exceeds 3 percent, even during the winter months. The remaining 97 percent of the time, antenna heater power activated by a thermostatic device provides expensive and unnecessary insurance against icing.

The Rosemount system is designed to reduce antenna de-icing costs and to fully automate antenna de-icing systems.

The Rosemount system will detect ice and energize antenna heaters only when ice is physically present, but before ice accumulation can reduce antenna performance. The Rosemount system thus provides reliable, completely automated antenna icing protection at a fraction of the cost for continuous heater operation whenever the ambient temperature is below approximately 35°F (1.7°C). In many cases, the Rosemount system will pay for itself in less than one icing season.



Micro-Trak 2580 Antenna Heater Control System

The 2580 senses ambient atmospheric conditions and controls power to the element heaters in FM, TV, and other electrically heated antenna arrays. The system provides aural and visual indication of status, monitors the condition of the heater elements, and provides an alarm in the event of a failure. The 2580 reduces operational costs by continually sensing atmospheric conditions, thus restricting heater turn-on to ice-causing conditions: freezing temperatures and precipitation. The 2580 system consists of four basic components: 2580 Control Unit, 2580-TT Temperature Sensing Unit, 2580-PD Precipitation Detector, and the 2580-HF Heater Failure Sense Transformer. The system has been field-tested in depth to optimize design and ensure performance and reliability. Optional accessories (Remote Display Output Circuit, Remote Display Panel, Calibration Box, Power Contactors and Enclosures, and Slow Start Kit) are available.

Size:

Standard 3-1/2" (8.8 cm) x 19" (48.2 cm)

Rack Panel x 8" (20.3 cm) D

2580 Control Unit

2580-TT NPN Temperature Sensing Unit

2580-PD NPN Precipitation Detector

2580-HF NPN Heater Failure Sense
Transformer

Beacon Light Control

Fisher-Pierce 63305-DB beacon light control mounts in a standard commercial socket. It automatically controls broadcast tower lights directly, or with auxiliary contractors. An adjustable potentiometer allows adjustment for operation from 0 to 50 footcandles.

Power requirements:

105 to 130 volts: 50/60 Hz

Built-in load contractor:

Single-pole, single throw, double break;
30 amps

Load rating:

3000 watts

All specifications are subject to change without notice.

Foam-Dielectric 1-1/4" and 1-5/8" Antenna Transmission Line

	Foam 1-1/4"	Connectors	Foam 1-5/8"	Connectors
	Andrew	Andrew	Andrew	Andrew
Standard Cable, Standard Jacket	LDF6-50		LDF7-50A	
Standard Cable, Fire-Retardant Jacket	41690-46		41690-23	
1-5/8" EIA Flange, no gas barrier at interface ¹		L46R ²		L47R
7/8" EIA Flange, no gas barrier at interface ¹		L46S ²		L47S
"F" Flange (male) ³		L46F		L47F
"F" Flange (female) ⁴		Not available		201942
N Plug (male), mates with UG-23		L46W ²		Not available
N Jack (female), mates with UG-21		L46N ²		L47N
LC Plug (male), mates with UG-352		L46M ²		L47M
LC Jack (female), mates with UG-154		L46L ²		L47L
7/16 DIN male		L46DM ²		L47DM
7/16 DIN female		L46DF ²		L47DF
Splice		L46Z		L47Z
1-5/8" End Terminal ⁵		2061		2061
1-5/8" Gas Barrier ⁶		1261B		1261B
Hanger Kit		42396A-1		42396A-1
Hoisting Grip		24312A		24312A
Grounding Kit		2049893		2049893
Reattachment Kit		34767A-43		34767A-43

Notes: (1) Includes inner connector; (2) Includes pressure port for pressurization of antenna feed; (3) For attachment to "F" series antennas; (4) For connection to jumper cable; (5) For strap connection to center conductor, includes inner connector; (6) For connection to pressurized line, includes inner connector.

All specifications are subject to change without notice.

The LDF6-50 and LDF7-50A HELIAX foam-dielectric cables are designed for use as feeders for antennas used in the AM and FM broadcast bands. LDF6-50 provides a pressure path through the tubular inner conductor. All L46 connectors (except L46F) provide a pressure port on the connector body for completing a pressure path to air-dielectric feed antennas and other pressurized components.

Ideal for low power FM applications, LDF6-50 is the first and only currently available foam-dielectric cable allowing a pressurized antenna without a pressurized line.

Antenna Transmission Line Rigid 1-5/8"

Rigid: 1-5/8"

	Andrew	Cablewave	Myatt	Phelps-Dodge	Dielectric
20-Ft. Line Section, flange both ends	561	920124	201-001	1-158-50	DC-275-00
20-Ft. Line Section, flanged one end	561-11	920218	201-006	2-158-50	Not Available
20-Ft. Line Section, unflanged	561-21	920222	201-004	3-158-50	DC265-002
Elbow, 90-degree	1061	920226	201-020	4-158-50	DC275-017
Elbow, 45-degree	Not Available	920230	201-030	5-158-50	DC275-020
Flange, fixed	18631	920288	201-008	13-158	DC275-006
Flange, swivel	18041	920284	201-009	18-158-50	Not Available
Flange, field (Soft sold.)	1561A	Not Available	201-013	Not Available	DC275-014
Flange, unpressurized	Not Available	920304	Not Available	11-158	DC260-015
Inner Connector	34660	612874	201-010	12-158-50	DC275-011
Inner Connector for unflanged line only	Not Available	920300	201-014	27-158-50	DC365-007
Gas Barrier	1261B	920238	201-050	7-158-50	DC275-005
End Terminal	2061	920253	201-080	20-158-50H	Not Available
Hardware Set	11381-2	920273	201-012	26-158	DC270-012
O Ring Gasket	10683-406	520681-011	201-011	14-158	DC270
Fixed Hanger	13924	920303	201-142-1	51-158	DC270-034
Spring Hanger	14379	920311	201-042-3	91-158	DC270-036
Horizontal Hanger	3911	920319	201-042-12	71-158	DC270-030
Round Member Adaptor	13550	514542-003	Not Available	Use Cablewave	Use Cablewave
Angle Adaptor	13555A	920167-002	Not Available	Use Cablewave	Use Cablewave
Wall Feed Thru	3901	920322	201-042-5	111-158	DC270-028
Reducer, 1-5/8" TO 7/8"	1860A	920249	201-064	17-158-50	DC275-060
Reducer, 3 1/8" to 1-5/8"	1861	920250	301-064	17-318-50	DC375-060
Lateral Brace	3921	920316	201-042-8	131-158	Not Available

All specifications are subject to change without notice.

Rigid: 3-1/8 Antenna Transmission Line

Rigid 3-1/8"

	Andrew	Cablewave	Myatt	Phelps-Dodge	Dielectric
20-Ft. Line Section, flanged both ends	562A	920215	301-001	1-318-50	DC375-002
20-Ft. Line Section, flanged one end	562A-11	920219	301-006	2-318-50	Not Available
20-Ft. Line Section, unflanged	562A-21	920223	301-004	3-318-50	DC365-002
Elbow, 90-Degree, flanged	1062	920227	301-020	4-318-50	DC375-017
Elbow, 45-Degree	1162	920321	301-030	5-318-50	DC375-020
Flange, fixed	15840	920289	301-008	13-318	DC375-006
Flange, swivel	18200	920285	301-009	18-318-50	DC3601-015
Flange, field (soft solder)	1562A	Not Available	301-013	Not Available	DC375-014
Flange, unpressurized	Not Available	920305	301-014	11-318	DC360-015
Inner Connector	30079	622720	301-010ML	12-318-50	DC375-011
Inner Connector for unflanged line only	Not Available	920301	301-010ML	27-318-50	DC365-007
Gas Barrier	1262B	920239	301-050	7-318-50	DC375-005
End Terminal	2062	920254	301-080	20-318-50H	Not Available
Hardware Set	11381-3	920274	301-012	26-318	DC370-012
"O" Ring Gasket	10683-405	Use Phelps-Dodge	301-011	14-318	DC370-010
Fixed Hanger	13927	920309	301-042-1	51-318	DC370-034
Spring Hanger	13925	920312	301-042-3	91-318	DC370-036
Horizontal Hanger	3912	920320	301-042-9	71-318	DC370-028
Round Member Adaptor	31670-3	514542-003	Use Cablewave	Use Cablewave	Use Cablewave
Angle Adaptor	31768A	920167-004	Use Cablewave	Use Cablewave	Use Cablewave
Wall Feed Thru	3902	920323	301-042-5	111-318	DC370-028
Reducer, 6-1/8" to 3-1/8"	1872	920-251	601-064	17-618-50	DC675-061
Reducer, 3-1/8" to 1-5/8"	1861	920250	301-064	17-318-50	DC375-060
Lateral Brace	3922	920317	301-042-8	131-318	DC370-038

All specifications are subject to change without notice.

Antenna Transmission Line Rigid: 4-1/16"

Rigid: 4-1/16"

	Andrew	Cablewave	Myatt	Phelps-Dodge	Dielectric
20-Ft. Line Section, flanged both ends	ACA-450-1	Not Available	401-001	Not Available	475-002
20-Ft. Line Section, flanged one end only	ACX-450-4	N/A	Not Available	N/A	Not Available
20-Ft. Line Section, unflanged	ACX-450-5	N/A	401-004	N/A	465-002
Elbow, 90-Degree	ACX-450-10	N/A	401-020	N/A	475-017
Elbow, 45-Degree	Not Available	N/A	Not Available	N/A	475-020
Flange, fixed	ACX-450-28	N/A	401-008	N/A	475-006
Flange, swivel	ACX-450-27	N/A	401-009	N/A	460-013
Flange, field (soft solder)	Not Available	N/A	401-013	N/A	470-014
Flange, unpressurized	Not Available	N/A	401-014	N/A	460-015
Inner Connector	ACX-450-20	N/A	401-010	N/A	475-011
Inner Connector for unflanged line only	Not Available	N/A	use 401-010	N/A	465-007
Gas Barrier	ACX-450-16	N/A	401-050	N/A	475-005
End Terminal	Not Available	N/A	Not Available	N/A	Not Available
Hardware Set	ACX-450-21	N/A	401-012	N/A	470-012
"O" Ring Gasket	Not Available	N/A	401-011	N/A	470-010
Fixed Hanger	ACX-450-21	N/A	401-042-1	N/A	470-034
Spring Hanger	ACX-450-11	N/A	401-042-3	N/A	470-036
Horizontal Hanger	ACX-450-15	N/A	Not Available	N/A	Not Available
Round Member Adaptor	Cablewave-514542-004	N/A	514542-004	N/A	Not Available
Angle Adaptor	Cablewave-920167-004	N/A	Cablewave-920167-004	N/A	Not Available
Wall Feed Thru	Myatt-401-042-5	N/A	401-042-5	N/A	470-028
Reducer, 6-1/8" to 4-1/16"	Not Available	N/A	401-084	N/A	675-060
Lateral Brace	ACX450-11	N/A	401-042-8	N/A	470-038
Coupling, unpressurized	Myatt-401-017	N/A	Myatt-401-017	N/A	Myatt-401-017

All specifications are subject to change without notice.

Air Dielectric: 7/8" and 1-5/8" Antenna Transmission Line

	Air Dielectric: 7/8"		Air Dielectric: 1-5/8"		
	Andrew	Cablewave	Andrew	Cablewave	
Line Type Number	HJ5-50	FCC78-50J	HJ7-50A	HCC-158-50J	
Flange, gas pass EIA	75AR	738259	87R	738314	
Flange, gas barrier EIA	75AG	738256	87G	738303	
Flange, LC plug	75AM	738254	87L (female)	738302 (female)	
Flange, N-plug	75AN	738251	87N	738301 (female)	
End Terminal	75AT	738258	87T	738306	
Gas Barrier	1260A	920237	1261B	920238	
Splice	75AZ	738257	87Z	738305	
Hanger Kit, non-Insul., maximum spacing—3 feet	42396-5	920159-00	42396-2	920159-003	
Hardware Kit	31769-1	Not Available	31769-1	Not Available	
Angle Adaptor	31768A	920167-001	31768A	920167-002	
Round Member Adaptor, 1-2 inch leg diameter	31670-1	514542-002	31670-1	514542-002	
Round Member Adaptor, 2-3 inch leg diameter	31670-2	514542-003	31670-2	514542-003	
Insulated Hanger, maximum spacing 3 feet	11662-2	920150-002	33948-3	920161-003	
Hoisting Grip	19256B	910307	24312A	910311	
Wall Feed Thru	40656-1	920433	40656-2	920434	
Grounding-Kit	40993A-5	713737-004	40993A-2	713737-005	
Nylon Cable Ties (50 pieces)	40417	Not Available	40417	Not Available	
90-Degree Elbow	1060	920225	1061	920226	

All specifications are subject to change without notice.

Antenna Transmission Line Air Dielectric: 3" and 3-1/2"

Air Dielectric: 3"

Air Dielectric: 3-1/2"

	Andrew	Cablewave	Andrew	Cablewave	
Line Type Number	HJ8-50B	HCC-300-50J	Not Available	HCC-312-50J	
Flange, gas pass	78ARF	738355	N/A	734579	
Flange, gas barrier	78AGF	738350	N/A	734578	
End Terminal	2062	920254	N/A	920254	
Gas Barrier	Not Available	920239	N/A	920239	
Splice	78BZ	738352	N/A	734574	
Hanger Kit, maximum spacing 5', 10-pieces	31766-11	920159-004	N/A	920159-005	
Hardware Kit	31769-1	Not Available	N/A	Not Available	
Angle Adaptor	31768A	920167-004	N/A	920167-004	
Round Member Adaptor, 1-2" leg diameter	31670-1	514542-002	N/A	514542-002	
Round Member Adaptor, 2-3" leg diameter	31670-2	514542-003	N/A	514542-003	
Round Member Adaptor, 3-4" leg diameter	31670-3	514542-004	N/A	514542-004	
Insulated Hanger	33948-2	920161-002	N/A	920161-007	
Holsting Grip	26985A	913563	N/A	913563	
Wall Feed Thru	40394-2	920435	N/A	920572	
Grounding Kit	40993A-11	713737-006	N/A	713737-007	
Nylon Cable Ties (50 pieces per kit)	40417	Use Andrew	N/A	USE ANDREW	
90-Degree Elbow	1062	920227	N/A	920227	
45-Degree Elbow	1162	920231	N/A	920231	
Inner Connector	15093A	622720	N/A	622720	

All specifications are subject to change without notice.

Air Dielectric: 4" and 5" Antenna Transmission Line

Air Dielectric: 4"

Air Dielectric: 5"

	Andrew	Cablewave	Andrew	Cablewave	
Line Type Number	HJ11-50	HF 4-1/8" CUZY	HJ-9-50	Not Available	
Flange, gas pass	81RF	734646(6-1/8")	79R	N/A	
Flange, gas barrier	81GF	734645(6-1/8")	79G	N/A	
End Terminal	2062	920255	Not Available	N/A	
Gas Barrier	1262B(3-1/8")	920240	Not Available	N/A	
Splice	81Z	Not Available	79AZ	N/A	
Hanger Kit, max. spacing 5', 10-pieces	31766-10	920159-006	33598-5	N/A	
Hardware Kit	31769-1	Not Available	31769-1	N/A	
Angle Adaptor	31768A	920160	31768A	N/A	
Round Member Adaptor, 1-2" leg diameter	31670-1	514542-002	Not Available	N/A	
Round Member Adaptor, 2-3" leg diameter	31670-2	514542-003	514542-003	N/A	
Round Member Adaptor, 3-4" leg diameter	31670-3	514542-004	514542-004	N/A	
Insulated Hanger	33948-4	920161-008	33948-1	N/A	
Hoisting Grip	34759	913864	31031-1	N/A	
Wall Feed Thru	40394-1	920555	33938-5	N/A	
Grounding Kit	40993A-10	713737-008	40993A-14	N/A	
Nylon Cable Ties (50 pieces per kit)	40417	Use Andrew	40417	N/A	
90-Degree Elbow	1062(3-1/8")	920228(6-1/8")	Use Cablewave	N/A	
Reducer 6-1/8" to 3-1/8"	Use Cablewave	920251	Use Cablewave	N/A	
45-Degree Elbow	1162(3-1/8")	920232(6-1/8")	Use Cablewave	N/A	

All specifications are subject to change without notice.

Antenna Transmission Line Components 50 ohm, Rigid

Typical antenna transmission line components are shown below. Data supplied through courtesy of Cablewave Systems.

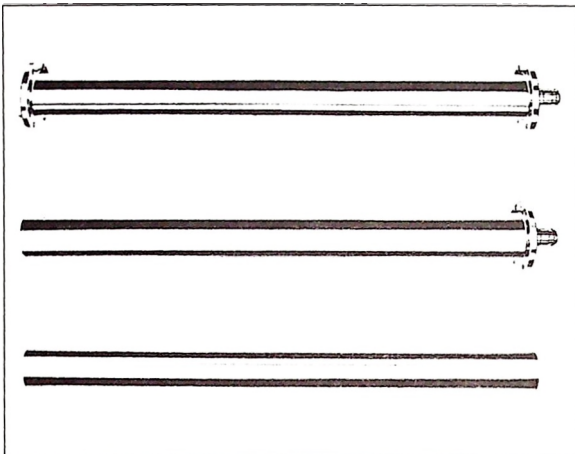

Cablewave systems coaxial transmission line is fabricated from high conductivity hard-drawn copper tubing with precision machined, pin-type, Teflon dielectric insulators. The standard 50 ohm line is offered in sizes from 7/8" through 6 1/2". The EIA bolt type flanges and inner connectors are compatible with EIA standards, US MIL specifications, and international IEC recommendations. Aluminum outer conductor 50 ohm and copper 75 ohm lines are available on special order.

Unless otherwise noted, the EIA flanges are the bolt type flanges defined in EIA Standard RS-225 with a female inner conductor, removable anchor inner connector with Teflon insulator, and a rotatable swivel-type outer flange ring. On many items, the EIA flange ring is soldered directly to the outer conductor and is designated as an "EIA male" flange. If the flange ring is fixed and the inner connector is unremovable, the flange is called "EIA fixed male".

The components shown are useful in both coaxial cable and rigid line installations.

For indoor applications, unflanged, ungasged line may be suitable. Unflanged components are joined by a slotted, unpressurized, straight brass coupling around the outer conductor and a silver plated inner connector for the center conductor connection.

ORDERING INFORMATION

Cablewave Systems Rigid Line Catalog numbers consists of a prefix to designate the component, and a suffix to call out line size and impedance.

Catalog number prefix "1" refers to a 20 foot length transmission line with EIA fixed flanges on both ends.

One anchor inner connector, one "O" ring gasket, and one hardware set are supplied.

Prefix "2" designates a 20 foot length of transmission line with one unflanged end, one EIA fixed flange, and one anchor inner connector, "O" ring and hardware set.

Catalog number prefix "3" denotes a 20 foot length of unflanged transmission line. No inner connector, "O" ring hardware is included.

Special high reliability coated anchor inner connectors are supplied with the 3 1/2" and 6 1/2" rigid line sections. These include a special dry baked molybdenum di-sulfide coating for long term, reliable lubrication to prevent conductor galling. All sizes of components and the 7/8" and 1 1/2" line sections include conventional silver plated anchor inner connectors.

*Prefix designations "1S," "2S," and "3S" refer to special lengths of rigid line in which the exact length in inches is added as a suffix after the impedance, i.e.: 1S-318-50 (24) for a 2 ft. (609mm) length of 3 1/2" 50 ohm line with EIA flanges on each end.

When ordering, part numbers where listed should also be used.

DESCRIPTION AND CATALOG NUMBERS

Size	20 Foot section, flanges both ends Cat. No. Part No.	20 Foot section, flange one end Cat. No. Part No.	20 Foot section, no flanges Cat. No. Part No.
7/8"	1-78-50 920213	2-78-50 920217	3-78-50 920221
1 1/2"	1-158-50 920214	2-158-50 920218	3-158-50 920222
3 1/2"	1-318-50 920215	2-318-50 920219	3-318-50 920223
6 1/2"	1-618-50 920216	2-618-50 920220	3-618-50 920224

Size	Special length, flanges both ends*	Special length, flange one end*	Special length, no flanges*
7/8"	1S-78-50	2S-78-50	3S-78-50
1 1/2"	1S-158-50	2S-158-50	3S-158-50
3 1/2"	1S-318-50	2S-318-50	3S-318-50
6 1/2"	1S-618-50	2S-618-50	3S-618-50

ELECTRICAL CHARACTERISTICS

Size	Impedance, Ohms	Maximum Frequency, MHz	Velocity percent	Attenuation and Average Power Rating	Peak Power, KW
7/8"	50	4,000	99.8	see curves pages 112, 113.	61
1 1/2"	50	3,000	99.8		234
3 1/2"	50	1,600	99.8		920
6 1/2"	50	800	99.8		3,590

MECHANICAL CHARACTERISTICS

Size	Outer Conductor O.D. x I.D. Inches (millimeters)	Inner Conductor O.D. x I.D. Inches (millimeters)	Shipping Carton Inches (millimeters)	Net Weight Per Length lbs. (Kg)	Number of Line Sections Per Carton	Shipping Weight Per Carton lbs. (Kg)
7/8"	.875 x .785 (22.2 x 20.0)	.341 x .291 (8.7 x 7.4)	13 x 13 x 245 (330 x 330 x 6223)	12 (5.5)	16	250 (114)
1 1/2"	1.625 x 1.527 (41.3 x 38.8)	.664 x .588 (16.9 x 14.9)	13 x 13 x 245 (330 x 330 x 6223)	27 (12.3)	9	303 (138)
3 1/2"	3.125 x 3.027 (79.4 x 76.9)	1.315 x 1.231 (33.4 x 31.3)	13 x 13 x 245 (330 x 330 x 6223)	52 (23.6)	4	268 (122)
6 1/2"	6.125 x 5.981 (155.6 x 151.9)	2.600 x 2.520 (66.0 x 64.0)	12 x 24 x 245 (305 x 610 x 6223)	135 (61.4)	2	370 (168)

Transmission Line Components 50 ohm, Rigid **Antenna**

Typical antenna transmission line components are shown below. Data supplied through courtesy of Cablewave Systems.

Unless otherwise noted flanges are standard EIA swivel flanges, and the component includes an anchor inner connector, "O" ring gasket, and hardware set for one end only

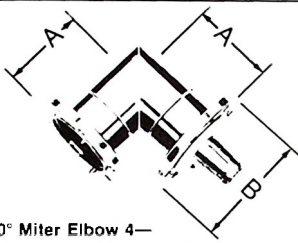
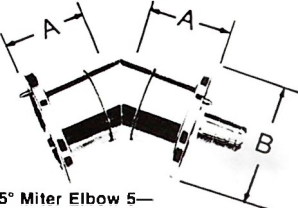
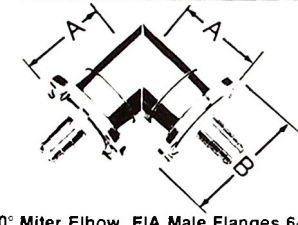
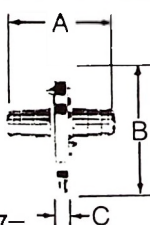
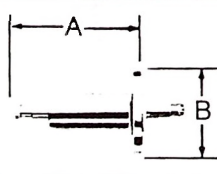
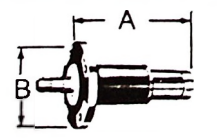
 <p>90° Miter Elbow 4—</p>	90° Miter Elbow. 50 ohm copper and brass construction. EIA swivel flanges. Unsupported silver plated inner conductor. One anchor inner connector, "O" ring, and hardware set.							
				Dimensions, inches (millimeters)		Weight, pounds (kilograms)		
	Size	Cat. No.	Part No.	A	B	Net	Shipping	
	7/8"	4-78-50	920225	2 3/4 (69.9)	2 1/4 (57.2)	1.3 (.6)	1.7 (.8)	
	1 1/8"	4-158-50	920226	2 1/2 (63.5)	3 1/2 (88.9)	3.4 (1.5)	3.8 (1.7)	
3/8"	4-318-50	920227	3 13/16 (96.8)	5 7/16 (131.8)	8.2 (3.7)	8.9 (4.0)		
6 1/8"	4-618-50	920228	5 1/2 (139.7)	8 1/8 (206.4)	22.0 (10)	26.0 (11.8)		
 <p>45° Miter Elbow 5—</p>	45° Miter Elbow. Copper and Brass construction. Unsupported inner conductor.							
				Dimensions, inches (millimeters)		Weight, pounds (kilograms)		
	Size	Cat. No.	Part No.	A	B	Net	Shipping	
	7/8"	5-78-50	920229	2 3/4 (69.9)	2 1/4 (57.2)	1.2 (.5)	1.6 (.7)	
	1 1/8"	5-158-50	920230	2 1/2 (63.5)	3 1/2 (88.9)	3.3 (1.5)	3.6 (1.6)	
3/8"	5-318-50	920231	3 1/2 (88.9)	5 7/16 (131.8)	7.9 (3.6)	8.6 (3.9)		
6 1/8"	5-618-50	920232	5 1/2 (139.7)	8 1/8 (206.4)	21.0 (9.5)	25.0 (11.3)		
 <p>90° Miter Elbow. EIA Male Flanges 6—</p>	90° Miter Elbow. Male. EIA male swivel flanges both ends. Silver plated, supported inner conductor. Two "O" rings and two sets of hardware included.							
				Dimensions, inches (millimeters)		Weight, pounds (kilograms)		
	Size	Cat. No.	Part No.	A	B	Net	Shipping	
	7/8"	6-78-50	920233	2 3/4 (69.9)	2 1/4 (57.2)	1.2 (.5)	1.6 (.7)	
	1 1/8"	6-158-50	920234	2 1/2 (63.5)	3 1/2 (88.9)	3.3 (1.5)	3.7 (1.7)	
3/8"	6-318-50	920235	3 13/16 (96.8)	5 7/16 (131.8)	8.2 (3.7)	8.9 (4.0)		
6 1/8"	6-618-50	920236	5 1/2 (139.7)	8 1/8 (206.4)	22.0 (10.0)	26.0 (11.8)		
 <p>Gas Barrier 7—</p>	Gas Barrier. Fixed male EIA inner connectors both ends. 1/8" FPT pressure inlet with plug. One set of longer bronze hardware, and two "O" rings.							
				Dimensions, inches (millimeters)		Weight, pounds (kilograms)		
	Size	Cat. No.	Part No.	A	B	C	Net	Shipping
	7/8"	7-78-50	920237	3 7/16 (84.1)	2 1/4 (57.2)	5/8 (15.9)	1.1 (.5)	1.3 (.6)
	1 1/8"	7-158-50	920238	3 1/2 (98.4)	3 1/2 (88.9)	5/8 (15.9)	3.4 (1.5)	4.1 (1.9)
3/8"	7-318-50	920239	4 7/8 (123.8)	5 7/16 (131.8)	5/8 (15.9)	6.2 (2.8)	7.0 (3.2)	
6 1/8"	7-618-50	920240	6 1/8 (155.6)	8 1/8 (206.4)	1 1/16 (27.0)	15.2 (6.9)	17.0 (7.7)	
 <p>Adapter — EIA to N Female 9—</p>	Adapter — EIA to type N Female. Mates with UG21/U. Gas tight with 1/8" FPT pressure inlet and plug.							
				Dimensions, inches (millimeters)		Weight, pounds (kilograms)		
	Size	Cat. No.	Part No.	A	B	Net	Shipping	
	7/8"	9-78-50	920241	4 (101.6)	2 1/4 (57.2)	6 (.3)	9 (.4)	
	1 1/8"	9-158-50	920242	5 (127.)	3 1/2 (88.9)	2.0 (.9)	2.7 (1.2)	
3/8"	9-318-50	920243	6 (152.4)	5 7/16 (131.8)	6.0 (2.7)	6.8 (3.1)		
 <p>Adapter — EIA to LC Female 24—</p>	Adapter — EIA to LC Female. Mates with UG154/U. Gas tight with 1/8" FPT pressure inlet and plug.							
				Dimensions, inches (millimeters)		Weight, pounds (kilograms)		
	Size	Cat. No.	Part No.	A	B	Net	Shipping	
	7/8"	24-78-50	920244	3 3/4 (95.3)	2 1/4 (57.2)	1.2 (.5)	1.4 (.6)	
	1 1/8"	24-158-50	920245	5 1/4 (133.4)	3 1/2 (88.9)	3.5 (1.6)	4.2 (1.9)	
3/8"	24-318-50	920246	5 7/16 (138.1)	5 7/16 (131.8)	6.3 (2.9)	7.1 (3.2)		



Antenna Transmission Line Components 50 ohm, Rigid

Typical antenna transmission line components are shown below. Data supplied through courtesy of Cablewave Systems.

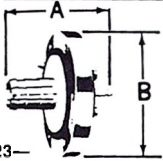
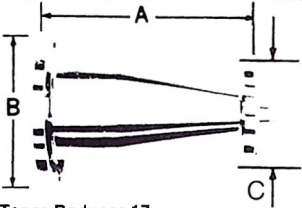
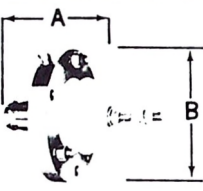
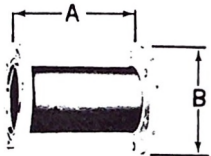
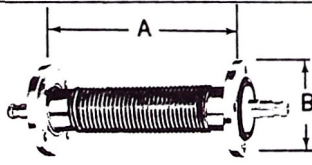
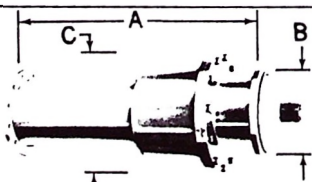
Unless otherwise noted flanges are standard EIA swivel flanges, and the component includes an anchor inner connector, "O" ring gasket, and hardware set for one end only.

 <p>Plate Reducer 23—</p>	Plate Reducer. Quick step type. Fixed male inner connectors on both ends. "O" rings and hardware included for both ends.						
	Size	Cat. No.	Part No.	Dimensions, inches (millimeters)		Weight, pounds (kilograms)	
1½" — 7/8"	23-158-50	920247	A	B	Net	Shipping	
			¾	3½	3.0	3.6	
			(19.0)	(88.9)	(1.36)	(1.63)	
3½" — 1½"	23-318-50	920248	7/8	5 ³ / ₁₆	5.0	5.8	
			(22.2)	(131.8)	(2.27)	(2.63)	
 <p>Taper Reducer 17—</p>	Taper Reducer. Low VSWR (1.05 @ 1.0 GHz). Fixed EIA flanges both ends. Unsupported inner conductor. Removable anchor inner connector, "O" ring and hardware included for smaller size flange only.						
	Size	Cat. No.	Part No.	Dimensions, inches (millimeters)		Weight, pounds (kilograms)	
1½" — 7/8"	17-158-50	920249	A	B	C	Net	Shipping
			4 ²⁷ / ₆₄	3½	2¼	1.75	2.4
			(112.3)	(88.9)	(57.2)	(0.8)	(1.1)
3½" — 1½"	17-318-50	920250	7 ³ / ₃₂	5 ³ / ₁₆	3½	4.1	5.0
			(180.0)	(131.8)	(88.9)	(1.9)	(2.3)
6½" — 3½"	17-618-50	920251	8¼	8½	5 ³ / ₁₆	11.5	12.5
			(209.5)	(206.4)	(131.8)	(5.2)	(5.7)
 <p>End Terminal 20—</p>	End Terminal. For strap connection to antenna. Pressure tight with 1/8" FPT gas inlet and plug. Fixed EIA flange with male inner connector. "O" ring and hardware included.						
	Size	Cat. No.	Part No.	Dimensions, inches (millimeters)		Weight, pounds (kilograms)	
7/8"	20-78-50H	920252	A	B	Net	Shipping	
			4½	2¼	1.0	1.4	
			(114.3)	(57.2)	(0.5)	(0.6)	
1½"	20-158-50H	920253	5	3½	2.6	3.4	
			(127.0)	(88.9)	(1.2)	(1.5)	
3½"	20-318-50H	920254	6½	5 ³ / ₁₆	4.4	5.4	
			(165.1)	(131.8)	(2.0)	(2.5)	
6½"	20-618-50H	920255	8	8½	11.7	12.8	
			(203.2)	(206.4)	(5.3)	(5.8)	
 <p>Adapter — Male to Male 21—</p>	Adapter — Male to Male. Unsupported inner conductor. Fixed EIA flanges. One "O" ring and hardware set included. No anchor inner connector included.						
	Size	Cat. No.	Part No.	Dimensions, inches (millimeters)		Weight, pounds (kilograms)	
7/8"	21-78-50	920256	A	B	Net	Shipping	
			4	2¼	1.0	1.5	
			(101.6)	(57.2)	(0.5)	(0.7)	
1½"	21-158-50	920257	4	3½	2.4	3.2	
			(101.6)	(88.9)	(1.1)	(1.5)	
3½"	21-318-50	920258	6	5 ³ / ₁₆	6.0	7.0	
			(152.4)	(131.8)	(2.7)	(3.2)	
6½"	21-618-50	920259	6	8½	18.0	23.0	
			(152.4)	(206.4)	(8.2)	(10.4)	
 <p>Flexible Section 30—</p>	Flexible Section accommodates vibration and angles up to 30° for 1½" and 20° for 6½". Maximum offset or compression is .25" (0.64 cm) for 1½" and .5" (1.27 cm) for the 3½" and 6½" units. EIA fixed male flanges both ends. Two sets of "O" rings and hardware supplied.						
	Size	Cat. No.	Part No.	Dimensions, inches (millimeters)		Weight, pounds (kilograms)	
1½"	30-158-50	920260	A	B	Net	Shipping	
			10	3½	4.2	4.7	
			(254.0)	(88.9)	(1.9)	(2.1)	
3½"	30-318-50	920261	18	5 ³ / ₁₆	15.0	16.9	
			(457.2)	(131.8)	(6.8)	(7.7)	
6½"	30-618-50	920262	24	8½	31.0	36.0	
			(609.6)	(206.4)	(14.1)	(16.3)	
 <p>Breakaway Section 31—</p>	Breakaway Section. Permits easy opening and disassembly of transmission line. Pressure tight when closed. EIA fixed flange on one end. EIA male anchor inner connector on one end.						
	Size	Cat. No.	Part No.	Dimensions, inches (millimeters)		Weight, pounds (kilograms)	
1½"	31-158-50	920263	A	B	C	Net	Shipping
			12	3½	4¼	14.0	18.0
			(304.8)	(88.9)	(108.0)	(6.35)	(8.16)
3½"	31-318-50	920264	14 ³ / ₁₆	5 ³ / ₁₆	7	21.0	34.0
			(376.2)	(131.8)	(177.8)	(9.53)	(15.42)
6½"	31-618-50	920265	24	8½	10¼	47.0	59.0
			(609.6)	(206.4)	(260.4)	(21.32)	(26.8)

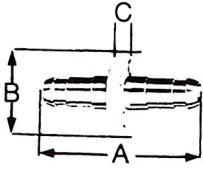
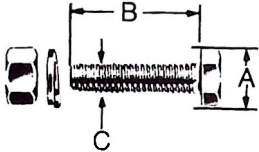
Typical antenna transmission line components are shown below. Data supplied through courtesy of Cablewave Systems.

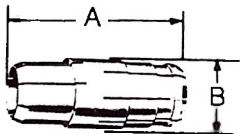
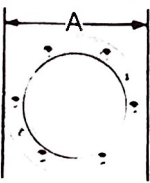
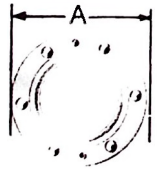
	Anchor Inner Connector. With Teflon insulator. Standard type 12— is silver plated. Inner connectors type 12A— include a dry baked molybdenum di-sulfide lubricant coating to prevent galling and electrical deterioration with repeated thermal expansion and contraction of the inner conductor.						
	Size	Cat. No.	Part No.	Dimensions, inches (millimeters)			Weight, pounds (kilograms)
			A	B	C	Net	Shipping
7/8"	12-78-50	612951	2 1/16 (68.3)	0.810 (20.6)	3/16 (4.8)	0.1 (.05)	0.1 (.05)
1 1/8"	12-158-50	612874	3 1/4 (82.6)	1.645 (41.9)	1/4 (6.4)	0.2 (.09)	0.2 (.09)
3/8"	12-318-50	622720	4 1/4 (108)	3.195 (81.2)	3/8 (9.5)	0.8 (.4)	1.0 (.45)
6 1/8"	12-618-50	920270	5 1/2 (139.7)	6.055 (153.8)	7/16 (11.1)	2.9 (1.3)	3.5 (1.6)
6 1/8"	12A-618-50	920271					
	Hardware Set Stainless steel.						
	Size	Cat. No.	Part No.	Qty Per Set	Dimensions, inches (millimeters)		
				A	B		
7/8"	26-78	920272	3	7/16 (11.1)	1 (25.4)		1/4-20 UNC
1 1/8"	26-158	920273	4	1/2 (12.7)	1 1/8 (34.9)		3/16-18 UNC
3 1/8"	26-318	920274	6	3/4 (14.3)	1 3/8 (34.9)		3/8-16 UNC
6 1/8"	26-618	920275	12	7/16 (14.3)	1 3/4 (44.5)		3/8-16 UNC
	"O" Ring Gasket for EIA flange. Silicone rubber.						
	Size	Cat. No.	Part No.	Size	Cat. No.	Part No.	
7/8"	14-78	510681-010		3 1/8"	14-318	510681-012	
1 1/8"	14-158	510681-011		6 1/8"	14-618	920279	
	Inner Connector Adaptor to connect 50 ohm EIA flanged line to 51 5 ohm flanged line. No anchor beads.						
	Size	Cat. No.	Part No.	Dimensions, inches (millimeters)		Weight, pounds (kilograms)	
			A	B	Net	Shipping	
7/8"	32-78-50	920280	2 5/16 (58.7)	.341 (8.7)	0.1 (.05)	0.1 (.05)	
1 1/8"	32-158-50	920281	2 3/4 (69.9)	.664 (16.9)	0.2 (.09)	0.2 (.09)	
3 1/8"	32-318-50	920282	3 3/8 (85.7)	1.315 (33.4)	0.8 (.4)	1.0 (.45)	
6 1/8"	32-618-50	920597	3 3/8 (92.1)	2.600 (66.5)	2.9 (1.3)	3.5 (1.6)	
	Swivel Flange kit for silver brazing of an EIA swivel flange to outer conductor tubing. Includes silver solder preform ring.						
	Size	Cat. No.	Part No.	Dimensions, inches (millimeters)		Weight, pounds (kilograms)	
			A		Net	Shipping	
7/8"	18-78-50	920283	2 1/4 (57.1)		.5 (.2)	1 (.4)	
1 1/8"	18-158-50	920284	3 1/2 (88.9)		.8 (.3)	1.3 (.6)	
3 1/8"	18-318-50	920285	5 1/16 (131.7)		1.6 (.7)	2.0 (.9)	
6 1/8"	18-618-50	920286	8 1/8 (206.4)		5.3 (2.4)	6 (2.7)	
	Fixed Flange kit for silver brazing of EIA fixed flange to outer conductor tubing. Includes silver solder preform ring.						
	Size	Cat. No.	Part No.	Dimensions, inches (millimeters)		Weight, pounds (kilograms)	
			A		Net	Shipping	
7/8"	13-78	920287	2 1/4 (57.1)		.5 (.09)	1 (.4)	
1 1/8"	13-158	920288	3 1/2 (88.9)		.8 (.4)	1.3 (.6)	
3 1/8"	13-318	920289	5 1/16 (131.7)		1.6 (.7)	2.0 (.9)	
6 1/8"	13-618	920290	8 1/8 (206.4)		5.3 (2.4)	6 (2.7)	

Antenna Transmission Line Components 50 ohm, Rigid

Typical antenna transmission line components are shown below. Data supplied through courtesy of Cablewave Systems.

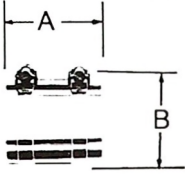
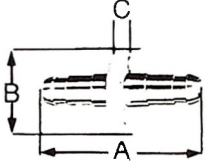
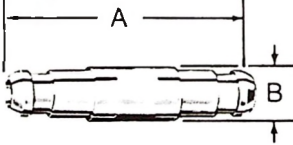
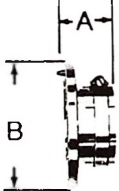
 <p>Unflanged 90° miter elbow 25—</p>	<p>Unflanged 90° Elbow. Unflanged elbow. No straight coupling or inner connector included. 7/8" sizes have supported inner conductor. 1 1/8", 3 1/8" and 6 1/8" sizes have nonsupported inner conductor.</p> <table border="1"> <thead> <tr> <th rowspan="2">Size</th> <th rowspan="2">Cat. No.</th> <th rowspan="2">Part No.</th> <th colspan="3">Dimensions, inches (millimeters)</th> <th colspan="2">Weight, pounds (kilograms)</th> </tr> <tr> <th>A</th> <th>B</th> <th>C</th> <th>Net</th> <th>Shipping</th> </tr> </thead> <tbody> <tr> <td>7/8"</td> <td>25-78-50</td> <td>920291</td> <td>2 1/16 (68)</td> <td>2 1/16 (68)</td> <td>875 (22.2)</td> <td>1.2 (.5)</td> <td>1.6 (.7)</td> </tr> <tr> <td>1 1/8"</td> <td>25-158-50</td> <td>920292</td> <td>2 3/8 (60)</td> <td>2 3/8 (60)</td> <td>1.625 (41.3)</td> <td>3.2 (1.5)</td> <td>3.6 (1.6)</td> </tr> <tr> <td>3 1/8"</td> <td>25-318-50</td> <td>920293</td> <td>3 3/8 (92)</td> <td>3 3/8 (92)</td> <td>3.125 (79.4)</td> <td>7.9 (3.6)</td> <td>8.9 (4.0)</td> </tr> <tr> <td>6 1/8"</td> <td>25-618-50</td> <td>920294</td> <td>5 7/32 (134)</td> <td>5 7/32 (134)</td> <td>6.125 (155.6)</td> <td>21.0 (9.5)</td> <td>25.0 (11.3)</td> </tr> </tbody> </table>	Size	Cat. No.	Part No.	Dimensions, inches (millimeters)			Weight, pounds (kilograms)		A	B	C	Net	Shipping	7/8"	25-78-50	920291	2 1/16 (68)	2 1/16 (68)	875 (22.2)	1.2 (.5)	1.6 (.7)	1 1/8"	25-158-50	920292	2 3/8 (60)	2 3/8 (60)	1.625 (41.3)	3.2 (1.5)	3.6 (1.6)	3 1/8"	25-318-50	920293	3 3/8 (92)	3 3/8 (92)	3.125 (79.4)	7.9 (3.6)	8.9 (4.0)	6 1/8"	25-618-50	920294	5 7/32 (134)	5 7/32 (134)	6.125 (155.6)	21.0 (9.5)	25.0 (11.3)
Size	Cat. No.				Part No.	Dimensions, inches (millimeters)			Weight, pounds (kilograms)																																					
		A	B	C		Net	Shipping																																							
7/8"	25-78-50	920291	2 1/16 (68)	2 1/16 (68)	875 (22.2)	1.2 (.5)	1.6 (.7)																																							
1 1/8"	25-158-50	920292	2 3/8 (60)	2 3/8 (60)	1.625 (41.3)	3.2 (1.5)	3.6 (1.6)																																							
3 1/8"	25-318-50	920293	3 3/8 (92)	3 3/8 (92)	3.125 (79.4)	7.9 (3.6)	8.9 (4.0)																																							
6 1/8"	25-618-50	920294	5 7/32 (134)	5 7/32 (134)	6.125 (155.6)	21.0 (9.5)	25.0 (11.3)																																							
 <p>Unflanged line straight coupling 16—</p>	<p>Unflanged Line Straight Coupling. Connects unflanged lines and fittings. Includes one inner connector and hose clamps.</p> <table border="1"> <thead> <tr> <th rowspan="2">Size</th> <th rowspan="2">Cat. No.</th> <th rowspan="2">Part No.</th> <th colspan="2">Dimensions, inches (millimeters)</th> <th colspan="2">Weight, pounds (kilograms)</th> </tr> <tr> <th>A</th> <th>B</th> <th>Net</th> <th>Shipping</th> </tr> </thead> <tbody> <tr> <td>7/8"</td> <td>16-78-50</td> <td>920295</td> <td>2 1/8 (54.0)</td> <td>1 1/8 (31.8)</td> <td>0.3 (.1)</td> <td>0.4 (.2)</td> </tr> <tr> <td>1 1/8"</td> <td>16-158-50</td> <td>920296</td> <td>2 1/4 (57.2)</td> <td>2 1/4 (57.2)</td> <td>0.5 (.2)</td> <td>0.6 (.3)</td> </tr> <tr> <td>3 1/8"</td> <td>16-318-50</td> <td>920297</td> <td>3 1/4 (82.6)</td> <td>3 1/2 (88.9)</td> <td>1.5 (.7)</td> <td>3.3 (1.5)</td> </tr> <tr> <td>6 1/8"</td> <td>16-618-50</td> <td>920298</td> <td>5 1/2 (139.7)</td> <td>6 3/4 (171.5)</td> <td>5.4 (2.5)</td> <td>6.5 (3.0)</td> </tr> </tbody> </table>	Size	Cat. No.	Part No.	Dimensions, inches (millimeters)		Weight, pounds (kilograms)		A	B	Net	Shipping	7/8"	16-78-50	920295	2 1/8 (54.0)	1 1/8 (31.8)	0.3 (.1)	0.4 (.2)	1 1/8"	16-158-50	920296	2 1/4 (57.2)	2 1/4 (57.2)	0.5 (.2)	0.6 (.3)	3 1/8"	16-318-50	920297	3 1/4 (82.6)	3 1/2 (88.9)	1.5 (.7)	3.3 (1.5)	6 1/8"	16-618-50	920298	5 1/2 (139.7)	6 3/4 (171.5)	5.4 (2.5)	6.5 (3.0)						
Size	Cat. No.				Part No.	Dimensions, inches (millimeters)		Weight, pounds (kilograms)																																						
		A	B	Net		Shipping																																								
7/8"	16-78-50	920295	2 1/8 (54.0)	1 1/8 (31.8)	0.3 (.1)	0.4 (.2)																																								
1 1/8"	16-158-50	920296	2 1/4 (57.2)	2 1/4 (57.2)	0.5 (.2)	0.6 (.3)																																								
3 1/8"	16-318-50	920297	3 1/4 (82.6)	3 1/2 (88.9)	1.5 (.7)	3.3 (1.5)																																								
6 1/8"	16-618-50	920298	5 1/2 (139.7)	6 3/4 (171.5)	5.4 (2.5)	6.5 (3.0)																																								
 <p>Anchor Inner Connector 12S—</p>	<p>Anchor Inner Connector for unflanged 50 ohm line. Teflon insulator, silver plated. Use with coupling 16-158-50 (P/N 920296) and 16-318-50 (P/N 920297).</p> <table border="1"> <thead> <tr> <th rowspan="2">Size</th> <th rowspan="2">Part No.</th> <th colspan="3">Dimensions, inches (millimeters)</th> <th colspan="2">Weight, pounds (kilograms)</th> </tr> <tr> <th>A</th> <th>B</th> <th>C</th> <th>Net</th> <th>Shipping</th> </tr> </thead> <tbody> <tr> <td>1 1/8"</td> <td>613946</td> <td>3 1/4 (82.6)</td> <td>1.625 (41.3)</td> <td>.250 (6.4)</td> <td>0.2 (.09)</td> <td>0.2 (.09)</td> </tr> <tr> <td>3 1/8"</td> <td>624054</td> <td>4.238 (107.7)</td> <td>3.125 (79.4)</td> <td>.373 (9.5)</td> <td>0.8 (.4)</td> <td>1.0 (.45)</td> </tr> </tbody> </table>	Size	Part No.	Dimensions, inches (millimeters)			Weight, pounds (kilograms)		A	B	C	Net	Shipping	1 1/8"	613946	3 1/4 (82.6)	1.625 (41.3)	.250 (6.4)	0.2 (.09)	0.2 (.09)	3 1/8"	624054	4.238 (107.7)	3.125 (79.4)	.373 (9.5)	0.8 (.4)	1.0 (.45)																			
Size	Part No.			Dimensions, inches (millimeters)			Weight, pounds (kilograms)																																							
		A	B	C	Net	Shipping																																								
1 1/8"	613946	3 1/4 (82.6)	1.625 (41.3)	.250 (6.4)	0.2 (.09)	0.2 (.09)																																								
3 1/8"	624054	4.238 (107.7)	3.125 (79.4)	.373 (9.5)	0.8 (.4)	1.0 (.45)																																								
 <p>Inner connector 27—</p>	<p>Inner Connector for unflanged unpressurized line. Silver plated, no undercut.</p> <table border="1"> <thead> <tr> <th rowspan="2">Size</th> <th rowspan="2">Cat. No.</th> <th rowspan="2">Part No.</th> <th colspan="2">Dimensions, inches (millimeters)</th> <th colspan="2">Weight, pounds (kilograms)</th> </tr> <tr> <th>A</th> <th>B</th> <th>Net</th> <th>Shipping</th> </tr> </thead> <tbody> <tr> <td>7/8"</td> <td>27-78-50</td> <td>522781</td> <td>2 1/16 (68.3)</td> <td>0.341 (8.7)</td> <td>0.1 (.05)</td> <td>0.1 (.05)</td> </tr> <tr> <td>1 1/8"</td> <td>27-158-50</td> <td>525641</td> <td>3 1/4 (82.6)</td> <td>0.664 (16.9)</td> <td>0.2 (.09)</td> <td>0.2 (.09)</td> </tr> <tr> <td>3 1/8"</td> <td>27-318-50</td> <td>534518</td> <td>4 1/4 (108.)</td> <td>1.315 (33.4)</td> <td>0.7 (.3)</td> <td>0.9 (.4)</td> </tr> <tr> <td>6 1/8"</td> <td>27-618-50</td> <td>920302</td> <td>5 1/2 (139.7)</td> <td>2.6 (66)</td> <td>2.7 (1.2)</td> <td>3.3 (1.5)</td> </tr> </tbody> </table>	Size	Cat. No.	Part No.	Dimensions, inches (millimeters)		Weight, pounds (kilograms)		A	B	Net	Shipping	7/8"	27-78-50	522781	2 1/16 (68.3)	0.341 (8.7)	0.1 (.05)	0.1 (.05)	1 1/8"	27-158-50	525641	3 1/4 (82.6)	0.664 (16.9)	0.2 (.09)	0.2 (.09)	3 1/8"	27-318-50	534518	4 1/4 (108.)	1.315 (33.4)	0.7 (.3)	0.9 (.4)	6 1/8"	27-618-50	920302	5 1/2 (139.7)	2.6 (66)	2.7 (1.2)	3.3 (1.5)						
Size	Cat. No.				Part No.	Dimensions, inches (millimeters)		Weight, pounds (kilograms)																																						
		A	B	Net		Shipping																																								
7/8"	27-78-50	522781	2 1/16 (68.3)	0.341 (8.7)	0.1 (.05)	0.1 (.05)																																								
1 1/8"	27-158-50	525641	3 1/4 (82.6)	0.664 (16.9)	0.2 (.09)	0.2 (.09)																																								
3 1/8"	27-318-50	534518	4 1/4 (108.)	1.315 (33.4)	0.7 (.3)	0.9 (.4)																																								
6 1/8"	27-618-50	920302	5 1/2 (139.7)	2.6 (66)	2.7 (1.2)	3.3 (1.5)																																								
 <p>Unpressurized EIA field flange 11—</p>	<p>Unpressurized EIA field flange does not include anchor inner connector. hardware or O ring. Not gas tight.</p> <table border="1"> <thead> <tr> <th rowspan="2">Size</th> <th rowspan="2">Cat. No.</th> <th rowspan="2">Part No.</th> <th colspan="2">Dimensions, inches (millimeters)</th> <th colspan="2">Weight, pounds (kilograms)</th> </tr> <tr> <th>A</th> <th>B</th> <th>Net</th> <th>Shipping</th> </tr> </thead> <tbody> <tr> <td>7/8"</td> <td>11-78</td> <td>920303</td> <td>1 (25.4)</td> <td>2 1/4 (57.2)</td> <td>7 (.3)</td> <td>1.2 (.5)</td> </tr> <tr> <td>1 1/8"</td> <td>11-158</td> <td>920304</td> <td>1 1/4 (31.8)</td> <td>3 1/2 (88.9)</td> <td>1.2 (.5)</td> <td>1.7 (.8)</td> </tr> <tr> <td>3 1/8"</td> <td>11-318</td> <td>920305</td> <td>1 11/16 (42.9)</td> <td>5 7/16 (131.8)</td> <td>2.5 (1.1)</td> <td>3.0 (1.4)</td> </tr> <tr> <td>6 1/8"</td> <td>11-618</td> <td>920306</td> <td>3 (76.2)</td> <td>8 1/8 (206.4)</td> <td>6.5 (3.0)</td> <td>7.0 (3.2)</td> </tr> </tbody> </table>	Size	Cat. No.	Part No.	Dimensions, inches (millimeters)		Weight, pounds (kilograms)		A	B	Net	Shipping	7/8"	11-78	920303	1 (25.4)	2 1/4 (57.2)	7 (.3)	1.2 (.5)	1 1/8"	11-158	920304	1 1/4 (31.8)	3 1/2 (88.9)	1.2 (.5)	1.7 (.8)	3 1/8"	11-318	920305	1 11/16 (42.9)	5 7/16 (131.8)	2.5 (1.1)	3.0 (1.4)	6 1/8"	11-618	920306	3 (76.2)	8 1/8 (206.4)	6.5 (3.0)	7.0 (3.2)						
Size	Cat. No.				Part No.	Dimensions, inches (millimeters)		Weight, pounds (kilograms)																																						
		A	B	Net		Shipping																																								
7/8"	11-78	920303	1 (25.4)	2 1/4 (57.2)	7 (.3)	1.2 (.5)																																								
1 1/8"	11-158	920304	1 1/4 (31.8)	3 1/2 (88.9)	1.2 (.5)	1.7 (.8)																																								
3 1/8"	11-318	920305	1 11/16 (42.9)	5 7/16 (131.8)	2.5 (1.1)	3.0 (1.4)																																								
6 1/8"	11-618	920306	3 (76.2)	8 1/8 (206.4)	6.5 (3.0)	7.0 (3.2)																																								

Typical antenna transmission line components are shown below. Data supplied through courtesy of Cablewave Systems.

VSWR Derating Factor K,
Versus Frequency

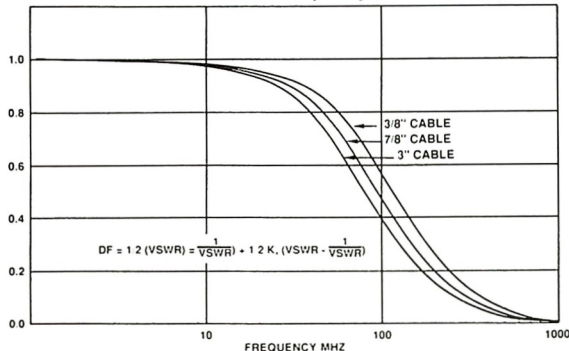

RECOMMENDED HANGER SPACINGS
FOR COAXIAL CABLE

Rated Max Wind Speed mph (km/h)	Radial Ice inches (mm)	1 ¹ / ₈ to 3 feet (m)	3 ¹ / ₈ feet (m)	3 ¹ / ₂ to 1 ¹ / ₂ feet (m)
90 (145)		6 (1.8)	4 (1.20)	3 (90)
110 (180)	no	5 (1.5)	4 (1.20)	3 (90)
130 (210)	ice	5 (1.5)	3 (90)	3 (60)
180 (290)		4 (1.2)	3 (90)	2 (60)
90 (145)	1/2 (12)	6 (1.8)	4 (1.20)	3 (90)
110 (180)		5 (1.5)	3 (90)	2 (60)
130 (210)		4 (1.2)	3 (90)	2 (60)
90 (145)	1 (25)	4 (1.2)	3 (90)	2 1/2 (75)
110 (180)		4 (1.2)	3 (90)	2 (60)
130 (210)		3 (0.9)	2 (60)	1 1/2 (45)
90 (145)	2 (50)	4 (1.2)	3 (90)	2 (60)
110 (180)		3 (0.9)	2 1/2 (75)	1 1/2 (45)
130 (210)		3 (0.9)	2 (60)	1 1/2 (60)

Peak Power Rating Improvement
Due To Pressurization

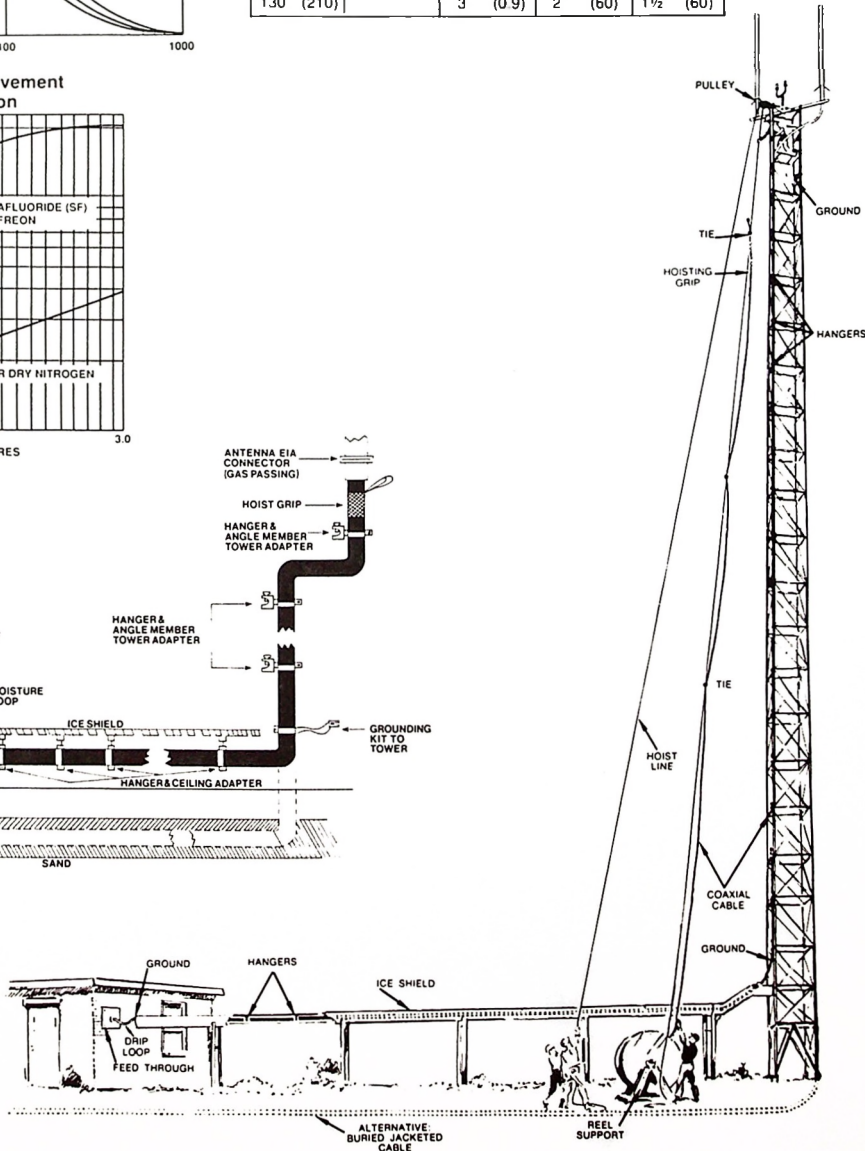
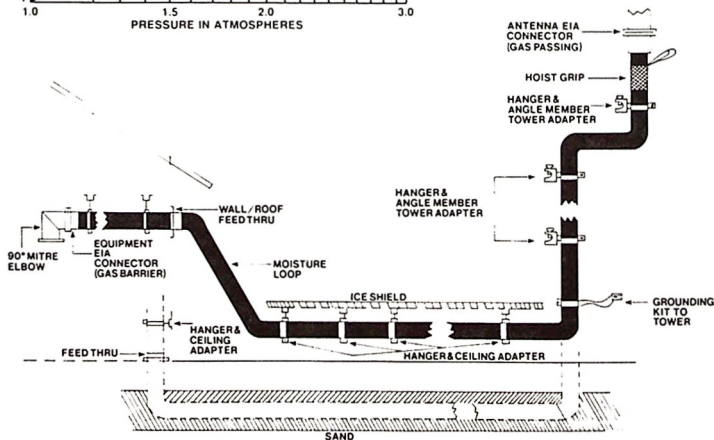
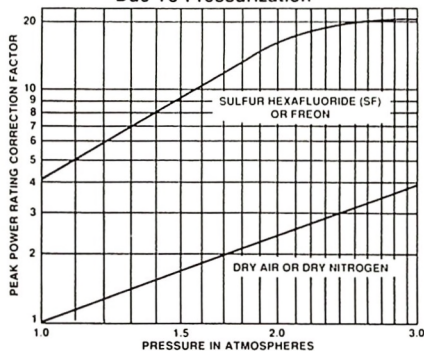

**Continental's Customer Service . . .
*The Industry's Best!***

Call Anytime, Day Or Night.

**Main Offices:
(214) 381-7161**

**Parts:
(214) 388-3737**

**Engineering Service:
(214) 388-5800**

Telex: 73-398

FAX: (214) 381-4949

varian 

continental electronics division

4212 South Buckner Blvd., PO Box 270879
Dallas, Texas 75227 Ph: (214) 381-7161



Engineering Data

Engineering Data

A	ampere	ips	inches per second	rms	root-mean-square
ac	alternating current	IRE	Institute of Radio Engineers	rpm	revolutions per minute
af	audio frequency	ISO	International Standards Organization	s	series as L_s
afc	automatic frequency control			s	second
AM	amplitude modulation	j	$\sqrt{-1}$	S	siemens
ASA	American Standards Association	k	kilo (10^3)	SCA	subsidiary carrier authorization
ASTM	American Society for Testing Materials	kg	kilogram	s/n	signal to noise
AVC	automatic volume control	kHz	kilohertz	STL	studio transmitter link
avg	average	kva	kilovolt ampere	swr	voltage standing wave ratio
B	susceptance	kw	kilowatt	sync	synchronous, synchronizing
BCD	binary-coded decimal	L	inductance	T	period
C	capacitance	lab	laboratory	t	temperature
C	Centigrade, degrees Centigrade	lb	pound	t	time
cm	centimeter	LC	inductance-capacitance	uhf	ultra-high frequency
COD	cash on delivery	lf	low frequency	v	velocity
CW	continuous wave	lm/sq		v	volt
DF	dissipation factor	ft	footcandle	va	voltampere
db	decibel	log	logarithm	vhf	very high frequency
dbm	decibel referred to one milliwatt	m	mass	vlf	very low frequency
dc	direct current	m	meter; milli (10^{-3})	vol	volume
DSB	double sideband	ma	milliampere	vrms	volt, root, mean, square
E	voltage	max	maximum	vs	versus
EIA	Electronics Industries Association	mbar	millibar	VU	volume unit
emf	electromotive power	mh	millihenry	w	watt
ERP	effective radiated power	MHz	megahertz	X	reactance
F	Fahrenheit, degrees Fahrenheit	mil	0.001 inch	Y	admittance
F	farad	min	minimum; minute	Z	impedance
f	frequency	mm	millimeter	α	short-circuit forward current-transfer ratio (common base)
FM	frequency modulation	mS	millisiemens	β	short-circuit forward current-transfer ratio (common emitter)
f.o.b.	free on board	m Ω	milliohm	L	reflection coefficient
G	conductance	M Ω	megohm	Δ	increment
g	gravitation constant	MM Ω	megamegohm	δ	loss angle
GHz	gigahertz	mv	millivolt	θ	phase angle
G_m	transconductance	mw	milliwatt	λ	wavelength
h	henry	NAB	National Association of Broadcasters	μ	micro- (10^{-6})
Hz	hertz	ns	nanosecond	μa	microampere
h_r	forward current-transfer ratio	nS	nanosiemens	μbar	microbar
h_i	Short-circuit input impedance	oz	ounce	μf	microfarad
h_o	open-circuit output admittance	PA	power amplifier	μh	microhenry
h_r	reverse voltage-transfer ratio	r	parallel, as L_r	μs	microsecond
I	current	PF	power factor	μv	microvolt
IEC	International Electrotechnical Commission	pF	picofarad	Ω	ohm
IEEE	Institute of Electrical and Electronics Engineers	PH	hydrogen in concentration	U	mho
IF	intermediate frequency	pp	push-pull; pages	w	angular velocity ($2\pi f$)
in.	inch	ppm	parts per million		
		p-p	peak-to-peak		
		prf	pulse repetition frequency		
		Q	quality factor		
		R	resistance		
		@	registered trademark		
		RC	resistance-capacitance		
		re	referred to		
		rf	radio frequency		
		RH	relative humidity		
		RIAA	Recording Industry Association of America		

Orders of magnitude from 10^{12} to 10^{-18} are designated by the following prefixes:

Order	Prefix	Symbol
10^{12}	tera	T
10^9	giga	G
10^6	mega	M

10^3	kilo	k	10^{-6}	micro	μ
10^2	hecto	h	10^{-9}	nano	n
10	deka	da	10^{-12}	pico	p
10^{-1}	deci	d	10^{-15}	femto	f
10^{-2}	centi	c	10^{-18}	atto	a
10^{-3}	milli	m			

Telephone Cable Color Code

Pair No.	Color	Mate
1	Blue	White
2	Orange	White
3	Green	White
4	Brown	White
5	Slate	White
6	Blue White	White
7	Blue Orange	White
8	Blue Green	White
9	Blue Brown	White
10	Blue Slate	White
11	Orange White	White
12	Orange Green	White
13	Orange Brown	White
14	Orange Slate	White
15	Green White	White
16	Green Brown	White
17	Green Slate	White
18	Brown White	White
19	Brown Slate	White
20	Slate White	White
21	Blue	Red
22	Orange	Red
23	Green	Red
24	Brown	Red
25	Slate	Red
26	Blue White	Red
27	Blue Orange	Red
28	Blue Green	Red
29	Blue Brown	Red
30	Blue Slate	Red
31	Orange White	Red
32	Orange Green	Red
33	Orange Brown	Red
34	Orange Slate	Red
35	Green White	Red
36	Green Brown	Red
37	Green Slate	Red
38	Brown White	Red
39	Brown Slate	Red
40	Slate White	Red
41	Blue	Black
42	Orange	Black
43	Green	Black
44	Brown	Black
45	Slate	Black
46	Blue White	Black

47	Blue Orange	Black
48	Blue Green	Black
49	Blue Brown	Black
50	Blue Slate	Black

Note—The last pair in all cables is a Red with White mate, viz.

6-pair cable	6th pair	Red	White
11-pair cable	11th pair	Red	White
16-pair cable	16th pair	Red	White
26-pair cable	26th pair	Red	White
51-pair cable	51st pair	Red	White

Convert Electrical Degrees to Feet, or Vice Versa When Frequency and Either Feet or Degrees in Known

From the expression

$$\begin{aligned} \text{Feet} &= \frac{\text{degrees}}{360^\circ} \times \frac{300}{f(\text{MHz})} \times 3.281 \\ &= \text{degrees} \times \frac{2.734}{f(\text{MHz})} \end{aligned}$$

The following ratio may be set up on the slide rule using C and D scales:

$$\frac{2.734}{f(\text{MHz})} = \frac{\text{feet}}{\text{degrees}}$$

Set 2.734 on scale C over frequency in megahertz on scale D; read feet and degrees on scales C and D, respectively. In some instances it may be convenient to use the folded scales CD and DF.

Metric Conversion

To convert pounds to kilograms, multiply by .4536

To convert inches to centimeters, multiply by 2.54

Engineering Data

Estimated Ground Conductivity

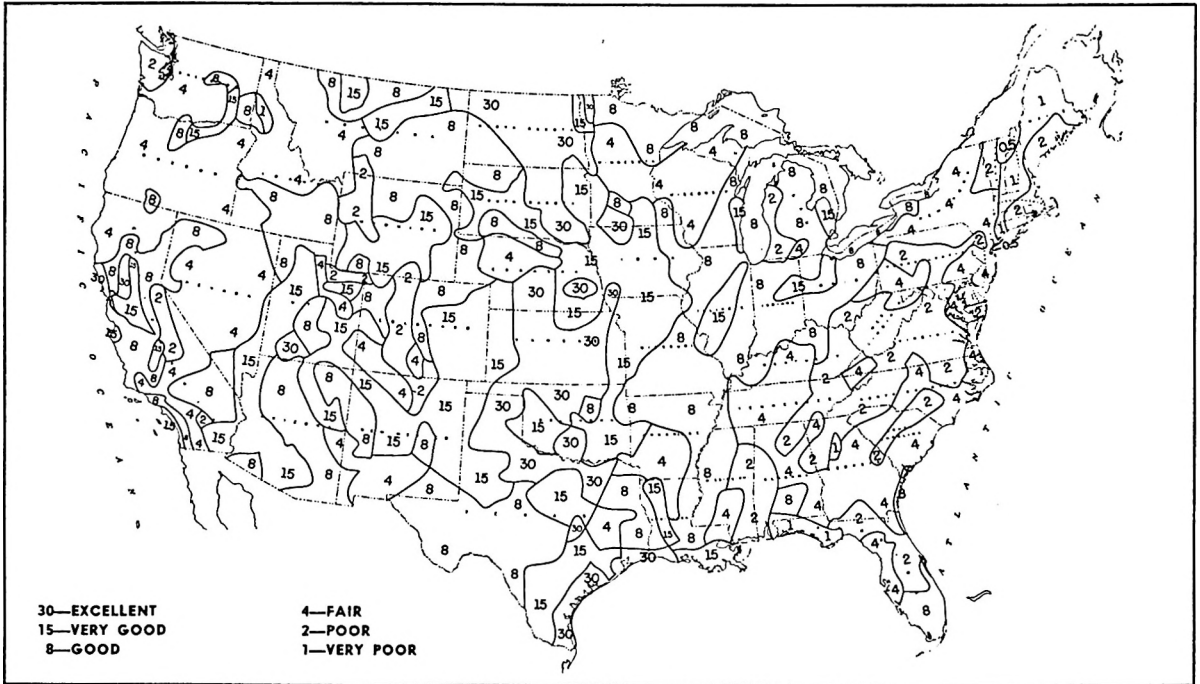

Conversion Table

MULTIPLY NUMBER OF BY TO OBTAIN NUMBER OF	ANGSTROMS	MICRONS	MILS	INCHES	FEET	MILES	MILLIMETERS	CENTIMETERS	KILOMETERS
ANGSTROMS	1	10^4	2.540×10^5	2.540×10^6	3.048×10^9	1.609×10^{13}	10^7	10^6	10^{13}
MICRONS	10^{-4}	1	2.540×10	2.540×10^4	3.048×10^5	1.609×10^9	10^3	10^4	10^9
MILS	3.937×10^{-6}	3.937×10^{-2}	1	10^3	1.2×10^4	6.336×10^7	3.937×10	3.937×10^2	3.937×10^7
INCHES	3.937×10^{-5}	3.937×10^{-5}	10^{-3}	1	12	6.336×10^4	3.937×10^{-2}	3.937×10^{-1}	3.937×10^4
FEET	3.281×10^{-10}	3.281×10^{-6}	8.333×10^{-5}	8.333×10^{-2}	1	5.280×10^3	3.281×10^{-3}	3.281×10^{-2}	3.281×10^3
MILES	6.214×10^{-14}	6.214×10^{-10}	1.578×10^{-8}	1.578×10^{-5}	1.894×10^{-4}	1	6.214×10^{-7}	6.214×10^{-6}	6.214×10^{-1}
MILLIMETERS	10^{-7}	10^{-3}	2.540×10^{-2}	2.540×10	3.048×10^2	1.609×10^6	1	10	10^6
CENTIMETERS	10^{-8}	10^{-4}	2.540×10^{-3}	2.540	3.048×10	1.609×10^5	0.1	1	10^5
KILOMETERS	10^{-13}	10^{-9}	2.540×10^{-8}	2.540×10^{-5}	3.048×10^{-4}	1.609	10^{-6}	10^{-5}	1

* CENTIGRADE

$C = 5/9 (F - 32)$

* FAHRENHEIT

$F = 9/5 C + 32$

Decibels above and below reference level 1mw into 600 ohms

Voltage applies to 600 ohm circuits only. Power applies to any impedance.

dB DOWN		LEVEL	dB UP	
VOLTS	MILLIWATTS	dB mW	VOLTS	MILLIWATTS
0.774 6	1.000	0+	0.774 6	1.000
0.690 5	0.794 3	1	0.869 1	1.259
0.616 7	0.631 0	2	0.975 2	1.585
0.548 4	0.501 2	3	1.094	1.995
0.488 7	0.398 1	4	1.228	2.512
0.435 6	0.316 2	5	1.377	3.162
0.388 2	0.251 2	6	1.546	3.981
0.346 0	0.199 5	7	1.734	5.012
0.308 4	0.158 5	8	1.946	6.310
0.274 8	0.125 9	9	2.183	7.943
0.244 9	0.100 0	10	2.449	10.000
0.218 3	0.079 43	11	2.748	12.59
0.194 6	0.063 10	12	3.084	15.85
0.173 4	0.050 12	13	3.460	19.95
0.154 6	0.039 81	14	3.882	25.12
0.137 7	0.031 62	15	4.356	31.62
0.122 8	0.025 12	16	4.887	39.81
0.109 4	0.019 95	17	5.484	50.12
0.097 52	0.015 85	18	6.153	63.10
0.086 91	0.012 59	19	6.905	79.43
0.077 46	0.010 00	20	7.746	100.00
0.043 56	0.003 16	25	13.77	316.2
0.024 49	0.001 00	30	24.49	1.000 Watt
0.013 77	0.000 316	35	43.56	3.162 Watts
0.007 746	0.000 100	40	77.46	10.00 Watts
0.004 356	3.16×10^{-5}	45	137.7	31.62 Watts
0.002 449	1.00×10^{-6}	50	244.9	100 Watts
0.001 377	3.16×10^{-8}	55	435.6	316.2 Watts
0.000 774 6	1.00×10^{-6}	60	774.6	1 000 Watts
0.000 435 6	3.16×10^{-7}	65	1 377	3 162 Watts
0.000 244 9	1.00×10^{-7}	70	2 449	10 000 Watts
0.000 137 7	3.16×10^{-8}	75	4 356	31 620 Watts
0.111 077 46	1.00×10^{-8}	80+	7 746	100 000 Watts

USE OF TABLE

Table is tabulated in 1-dB steps from 0 dB mW to ± 20 dB mW; thereafter in 5-dB steps to ± 80 dB mW. However, the table may be used in 1-dB steps to ± 80 dB mW by noting that, except for decimal locations, the power levels repeat themselves every ± 10 dB and the voltage levels repeat every ± 20 dB.

Example 1. What is the voltage produced by a level of -56 dB mW on 600 ohms? Subtract 40 from 56,

giving 16. Enter table at 16 dB mW, read volts column on left as 0.1228 volt. Now enter table at 55 and 60 dB mW; -56 dB mW is between these two levels, so table shows correct answer as 0.001228 volt.

Example 2. What is the voltage produced by a level of -68 dB mW on 600 ohms? Subtract 60 from 68, giving 8. Enter table at 7 dB mW, read volts column on left as 0.3084 volt. Now enter table at 65 and 70 dB mW; -68 dB mW is between

these two levels, so the table shows the correct answer as 0.0003084 volt.

Example 3. What is the voltage produced by a level of $+33$ dB mW on 600 ohms? Subtract 20 from 33, giving 13. Enter the table at 13 dB mW, read volts column at right as 3.460 volts. Now enter table at 30 and 35 dB mW; $+33$ dB mW is between these two levels, so the table shows the correct answer as 34.6 volts.

Engineering Data

Forward VS Reflected Power

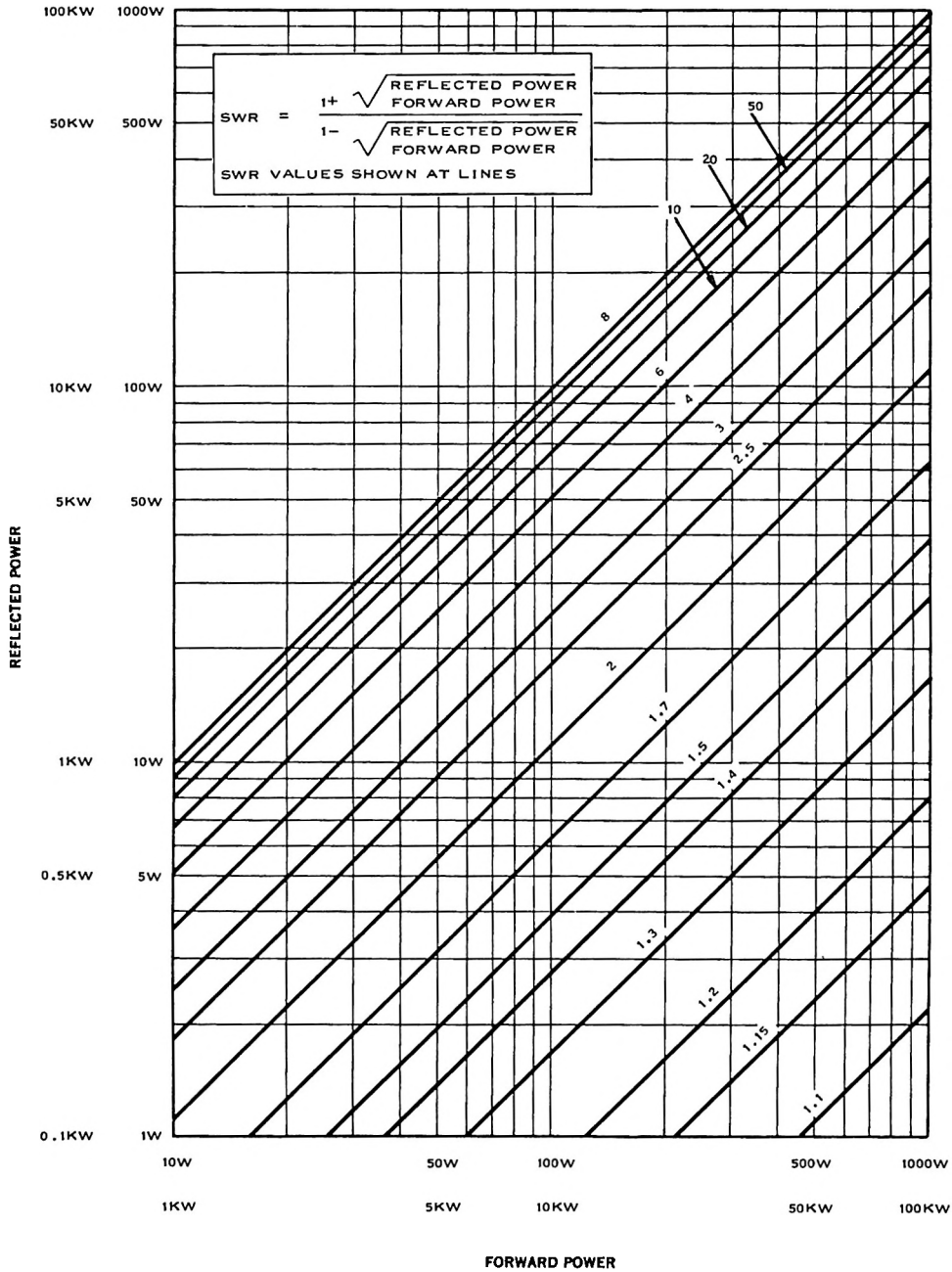

Attenuator Network

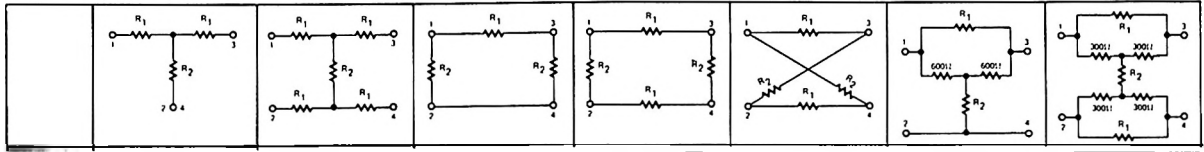

Impedance	600 Ohms		600 Ohms		600 Ohms		600 Ohms		600 Ohms		600 Ohms		600 Ohms	
Loss, dB	R ₁ Ohms	R ₂ Ohms	R ₁ Ohms	R ₂ Ohms	R ₁ Ohms	R ₂ Ohms	R ₁ Ohms	R ₂ Ohms	R ₁ Ohms	R ₂ Ohms	R ₁ Ohms	R ₂ Ohms	R ₁ Ohms	R ₂ Ohms
0	0	∞	0	∞	0	∞	0	∞	0	∞	0	∞	0	∞
0.1	3.58	50204	1.79	50204	7.20	100500	3.60	100500	3.58	100500	7.2	50000	3.6	50000
0.2	6.82	26280	3.41	26280	13.70	57380	6.85	57380	6.82	57380	13.8	26086	6.9	26086
0.3	10.32	17460	5.16	17460	20.55	34900	10.28	34900	10.32	34900	21.0	17143	10.5	17143
0.4	13.79	13068	6.90	13068	27.50	26100	13.80	26100	13.79	26100	28.2	12766	14.1	12766
0.5	17.20	10464	8.60	10464	34.40	20920	17.20	20920	17.20	20920	35.4	10169	17.7	10169
0.6	20.9	8640	10.45	8640	41.7	17230	20.85	17230	20.9	17230	43.2	8333	21.6	8333
0.7	24.2	7428	12.1	7428	48.5	14880	24.25	14880	24.2	14880	50.4	7143	25.2	7143
0.8	27.5	6540	13.75	6540	55.05	13100	27.53	13100	27.5	13100	57.6	6250	28.8	6250
0.9	31.02	5787	15.51	5787	62.3	11600	31.2	11600	31.02	11000	65.4	5504	32.7	5504
1.0	34.5	5208	17.25	5208	68.6	10440	34.3	10440	34.5	10440	73.2	4918	36.6	4918
1.5	51.8	3452	25.9	3452	104.3	6950	52.1	6950	51.8	6950	113.4	3174	56.7	3174
2.0	68.8	2582	34.4	2582	139.4	5232	69.7	5232	68.8	5232	155.4	2310	77.7	2316
2.5	85.9	2053	42.9	2053	175.4	4195	87.7	4195	85.9	4195	200.4	1796	100.2	1796
3.0	102.7	1703	51.3	1703	212.5	3505	106.2	3505	102.7	3505	247.8	1452	123.0	1452
3.5	119.2	1448	59.6	1448	258.0	3021	120.0	3021	119.2	3021	297.6	1209	148.8	1209
4.0	135.8	1249	67.9	1249	287.5	2651	143.8	2651	135.8	2651	361.0	1025	175.5	1025
4.5	152.2	1109	76.1	1109	324.6	2365	162.3	2365	152.2	2365	407.8	883.7	203.7	883.7
5.0	168.1	987.6	84.1	987.6	364.5	2141	182.3	2141	168.1	2141	466.8	771.2	233.4	771.2
5.5	184.0	886.8	92.0	886.8	405.9	1956	203.0	1956	184.0	1956	530.4	678.7	265.2	678.7
6.0	199.3	803.4	99.7	803.4	447.5	1807	223.8	1807	199.3	1807	597.0	603.0	298.6	603.0
6.5	214.6	730.8	107.3	730.8	492.6	1679	246.3	1679	214.6	1679	667.8	539.8	333.0	539.8
7.0	229.7	685.2	114.8	685.2	537.0	1569	268.5	1569	229.7	1569	743.4	484.3	371.7	484.3
7.5	244.2	615.6	122.1	615.6	584.7	1475	292.4	1475	244.2	1475	822.0	437.0	411.3	437.6
8.0	258.4	567.6	129.2	567.6	634.2	1393	317.1	1393	258.4	1393	907.2	396.8	453.6	396.8
8.5	272.3	525.0	136.1	525.0	685.5	1322	342.8	1322	272.3	1322	996.6	361.2	498.3	361.2
9.0	285.8	487.2	142.9	487.2	738.9	1260	369.4	1260	285.8	1260	1091	329.9	545.5	329.9
9.5	298.9	453.0	149.5	453.0	794.4	1204	397.2	1204	298.9	1204	1191	302.2	595.5	302.2
10.0	312.0	421.6	156.0	421.6	854.1	1154	427.0	1154	312.0	1154	1297	277.5	618.5	277.5
11.0	336.1	367.4	168.1	367.4	979.8	1071	489.9	1071	336.1	1071	1529	235.5	704.5	235.5
12.0	359.1	321.7	179.5	321.7	1119	1002	550.5	1002	359.1	1002	1788	201.3	804	201.3
13.0	380.5	282.8	190.3	282.8	1273	946.1	636.3	946.1	380.5	946.1	2080	173.1	1040.8	173.1
14.0	400.4	249.4	200.2	249.4	1443	899.1	721.5	899.1	400.4	899.1	2407	149.6	1204	149.6
15.0	418.8	220.4	209.4	220.4	1632	859.6	816.0	859.6	418.8	859.6	2773	129.8	1387	129.8
16.0	435.8	195.1	217.9	195.1	1847	826.0	923.2	826.0	435.8	826.0	3186	113.0	1599	113.0
17.0	451.5	172.9	225.7	172.9	2083	797.3	1042	797.3	451.5	797.3	3648	98.68	1824	98.68
18.0	465.8	152.5	232.9	152.5	2344	772.8	1172	772.8	465.8	772.8	4166	86.4	2083	86.4
19.0	479.0	136.4	239.5	136.4	2670	751.7	1335	751.7	479.0	751.7	4748	75.8	2374	75.8
20.0	490.4	121.2	245.2	121.2	2970	733.3	1485	733.3	490.4	733.3	5400	66.66	2700	66.66
22.0	511.7	95.9	255.9	95.9	3763	703.6	1877	703.6	511.7	703.6	6954	51.72	3477	51.72
24.0	528.8	76.0	264.4	76.0	4737	680.8	2369	680.8	528.8	680.8	8910	40.4	4455	40.4
26.0	542.7	60.3	271.4	60.3	5985	663.4	2992	663.4	542.7	663.4	11370	34.66	5685	34.66
28.0	554.1	47.8	277.0	47.8	7550	649.7	3775	649.7	554.1	649.7	14472	24.87	7236	24.87
30.0	563.0	37.99	281.0	37.99	9500	639.2	4750	639.2	563.0	639.2	18372	19.58	9186	19.58
32.0	570.6	30.16	285.3	30.16	11930	630.9	5967	630.9	570.6	630.9	23286	15.46	11643	15.46
34.0	576.5	23.95	288.3	23.95	15000	624.4	7500	624.4	576.5	624.4	29472	12.21	14736	12.21
36.0	581.1	18.98	290.6	18.98	18960	619.3	9480	619.3	581.1	619.3	37200	9.66	18630	9.66
38.0	585.1	15.11	292.5	15.11	23820	615.3	11910	615.3	585.1	615.3	47058	7.65	23529	7.65
40.0	588.1	12.00	294.1	12.00	30000	612.1	15000	612.1	588.1	612.1	59400	6.06	29700	6.06

Volume Level to Power and Voltage Conversion

REFERENCE LEVEL: 0 DBM = 1 MW, 600 OHMS

MILLIWATTS	VOLTS	DBM	WATTS	VOLTS	DBM
0.000001	0.0007746	-60	0.001000	0.7746	0
0.000010	0.002449	-50	0.002512	1.228	+4
0.000100	0.007746	-40	0.006310	1.946	+8
0.001	0.02449	-30	0.01000	2.449	+10
0.010	0.07746	-20	0.1000	7.746	+20
0.100	0.2449	-10	1.000	24.49	+30
1.000	0.7746	0	10.00	77.46	+40

Engineering Data

Frequency Designation of FM Broadcast Channels		93.7..... 229		97.3..... 247		100.9..... 265		104.5..... 283	
Freq. (MHz)	Channel No.	Freq. (MHz)	Channel No.	Freq. (MHz)	Channel No.	Freq. (MHz)	Channel No.	Freq. (MHz)	Channel No.
88.1	201	93.9	230	97.5	248	101.1	266	104.7	284
88.3	202	94.1	231	97.7	249	101.3	267	104.9	285
88.5	203	94.3	232	97.9	250	101.5	268	105.1	286
88.7	204	94.5	233	98.1	251	101.7	269	105.3	287
88.9	205	94.7	234	98.3	252	101.9	270	105.5	288
89.1	206	94.9	235	98.5	253	102.1	271	105.7	289
89.3	207	95.1	236	98.7	254	102.3	272	105.9	290
89.5	208	95.3	237	98.9	255	102.5	273	106.1	291
89.7	209	95.5	238	99.1	256	102.7	274	106.3	292
89.9	210	95.7	239	99.3	257	102.9	275	106.5	293
90.1	211	95.9	240	99.5	258	103.1	276	106.7	294
90.3	212	96.1	241	99.7	259	103.3	277	106.9	295
90.5	213	96.3	242	99.9	260	103.5	278	107.1	296
90.7	214	96.5	243	100.1	261	103.7	279	107.3	297
		96.7	244	100.3	262	103.9	280	107.5	298
		96.9	245	100.5	263	104.1	281	107.7	299
		97.1	246	1090.7	264	104.3	282	107.9	300

Decibels Vs Ratio

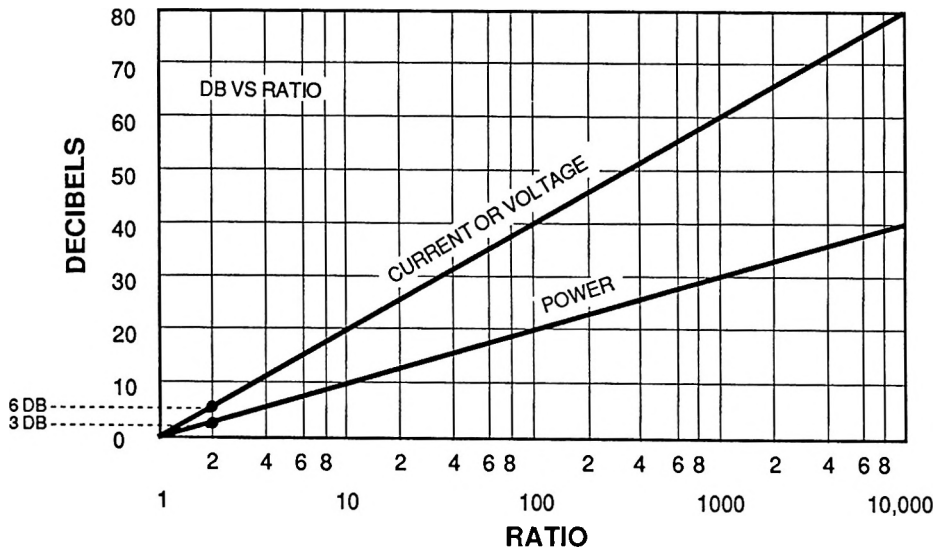

The following table is offered as a general guide to the classes of FM radio broadcast stations brought about by the FCC 80-90 docket. For specific interpretation and equipment requirements, see your engineering consultant.

Required Transmitter Power Out**	Antenna Bays	Effective Radiated Power**	Coax Line Size	Coax Line Length	Coax Line Efficiency	Tower Height**
Class A (3 kW) - 328 Feet						
7.6 kW	1	3 kW	1-5/8"	328'	85.0%	328'
3.7 kW*	2	3 kW	1-1/4"	342'	80.6%	333'
2.4 kW*	3	3 kW	1-1/4"	347'	80.8%	338'
Class A (6 kW) - 328 Feet						
4.8 kW*	3	6 kW	1-1/4"	337'	80.8%	338'
3.5 kW*	4	6 kW	1-1/4"	332'	81.1%	343'
2.2 kW	6	6 kW	1-1/4"	323'	81.5%	353'
Class B1 or C3 - 328 Feet						
13.0 kW	4	25 kW	3"	332'	89.6%	343'
10.3 kW*	5	25 kW	3"	327'	89.8%	348'
8.4 kW*	6	25 kW	3"	322'	89.9%	353'
7.1 kW	7	25 kW	3"	317'	90.1%	358'
6.2 kW	8	25 kW	3"	313'	90.2%	363'
Class B or C2 FM - 492 Feet						
21.7 kW	5	50 kW	3"	491'	85.1%	512'
17.8 kW*	6	50 kW	3"	486'	85.2%	517'
15.1 kW	7	50 kW	3"	481'	85.3%	522'
13.0 kW*	8	50 kW	3"	477'	85.4%	527'
11.6 kW	9	50 kW	3"	511'	85.5%	532'
10.4 kW	10	50 kW	3"	511'	85.5%	537'
Class C1 FM - 984 Feet						
39.1 kW	6	100 kW	3-1/8"	1,000'	77.4%	1,009'
28.8 kW	8	100 kW	3-1/8"	1,003'	77.4%	1,019'
24.5 kW*	10	100 kW	3"	1,003'	71.8%	1,029'
20.2 kW	12	100 kW	3"	1,003'	71.8%	1,039'
Class C FM - 1,968 Feet						
51.4 kW	6	100 kW	4"	1,987'	58.9%	1,993'
37.8 kW	8	100 kW	4"	1,987'	58.9%	2,003'
29.2 kW*	10	100 kW	3-1/8"	1,987'	60.2%	2,013'
20.2 kW*	12	100 kW	3"	1,987'	51.9%	2,023'

*Most commonly requested antenna transmitter combinations.
(Even number of bays required for beam tilt and null fill)

** Shown with maximum effective radiated power (e.r.p.) and maximum height allowed.

Engineering Data

Footage Table for Broadcast Tower Heights

550 KHZ TO 1070 KHZ					1080 KHZ TO 1600 KHZ				
KHZ	METERS	1 WAVE	½ WAVE	¼ WAVE	KHZ	METERS	1 WAVE	½ WAVE	¼ WAVE
550	545	1787.6	893.8	446.8	1080	277.8	911.1	455.5	227.7
560	536	1758.0	879.0	439.5	1090	275.2	902.6	451.3	225.6
570	526	1725.3	862.6	431.3					
580	517	1695.7	847.8	423.9	1100	272.7	894.4	447.2	223.6
590	509	1669.5	834.7	417.3	1110	270.3	886.5	443.2	221.6
					1120	267.9	879.0	439.5	219.7
600	500	1640.0	820.0	410.0	1130	265.5	870.8	435.4	217.7
610	492	1612.7	806.3	403.1	1140	263.2	862.6	431.3	215.6
620	484	1587.5	799.7	396.8	1150	260.9	855.7	427.8	213.9
630	476	1561.2	780.6	390.3	1160	258.6	847.8	423.9	211.9
640	469	1546.3	773.1	386.5	1170	256.4	840.9	420.4	210.2
650	462	1515.3	757.6	378.8	1180	254.2	834.7	417.3	208.6
660	455	1492.4	746.2	373.1	1190	252.1	826.8	413.4	206.7
670	448	1469.4	734.7	367.3					
680	441	1446.4	723.2	361.1	1200	250.0	820.0	410.0	205.0
690	435	1426.4	713.2	361.2	1210	247.9	813.1	406.5	203.2
					1220	245.9	806.3	403.1	201.5
700	429	1407.1	703.5	351.2	1230	243.9	799.1	399.5	199.7
710	423	1387.4	693.7	346.8	1240	241.9	793.7	396.8	198.4
720	417	1367.7	683.8	341.9	1250	240.0	787.2	393.6	196.8
730	411	1348.0	674.0	337.0	1260	238.1	780.9	390.4	195.2
740	405	1328.4	664.2	332.1	1270	236.2	774.7	387.3	193.6
750	400	1312.0	656.0	328.0	1280	234.4	768.8	384.4	192.2
760	395	1295.6	647.8	323.4	1290	232.6	762.9	381.4	190.7
770	390	1279.2	639.6	319.8					
780	385	1262.8	631.4	315.7	1300	230.8	757.0	378.5	189.2
790	380	1246.4	623.2	311.6	1310	229.0	751.1	375.5	187.7
					1320	227.3	746.2	373.1	186.5
800	375	1230.0	615.0	307.5	1330	225.6	739.9	369.9	184.9
810	370	1213.6	606.8	303.4	1340	223.9	734.7	367.3	183.6
820	366	1200.4	600.2	300.1	1350	222.2	728.8	364.4	182.2
830	361	1184.0	592.0	296.0	1360	220.6	723.2	361.1	180.5
840	357	1170.9	585.4	292.7	1370	219.0	718.3	359.1	179.5
850	353	1157.8	578.9	289.4	1380	217.4	713.4	356.2	178.1
860	349	1144.7	572.3	286.1	1390	215.8	707.8	353.1	176.5
870	345	1131.6	565.8	282.9					
880	341	1118.4	559.2	279.6	1400	214.3	703.5	351.2	175.6
890	337	1105.3	552.6	276.3	1410	212.8	696.9	348.4	174.2
					1420	211.3	693.7	346.8	173.4
900	333	1092.2	546.1	273.0	1430	209.8	688.1	344.0	172.0
910	330	1082.4	541.2	270.6	1440	208.3	683.8	341.9	170.9
920	326	1069.2	534.6	267.3	1450	206.9	678.6	339.3	169.6
930	323	1059.4	529.7	264.8	1460	205.5	674.0	337.0	168.5
940	319	1046.3	523.1	261.5	1470	204.1	669.4	334.7	167.3
950	316	1036.4	518.2	259.1	1480	202.7	664.2	332.1	166.5
960	313	1026.6	513.3	256.6	1490	201.3	660.2	330.1	165.0
970	309	1013.5	506.7	253.3					
980	306	1003.6	501.8	250.9	1500	200.0	656.0	328.0	164.0
990	303	993.8	496.9	248.4	1510	198.7	651.7	325.8	162.9
					1520	197.4	647.8	323.4	161.7
1000	300	984.0	492.0	246.0	1530	196.1	643.2	321.6	160.8
1010	297	974.1	487.5	243.7	1540	194.8	639.6	319.8	159.9
1020	294.1	964.6	482.3	241.1	1550	193.5	634.6	317.3	158.6
1030	291.3	955.3	477.6	238.8	1560	192.3	631.4	315.7	157.8
1040	288.5	946.2	473.1	236.5	1570	191.1	626.8	313.4	156.7
1050	285.7	937.1	468.5	234.2	1580	189.9	623.2	311.6	155.8
1060	283.0	928.2	464.1	232.0	1590	188.7	618.9	309.4	154.7
1070	280.4	919.7	459.8	229.9					
					1600	187.6	615.0	307.5	153.7

DISTANCE IN MILES TO RECEIVING LOCATION AND DEPRESSION ANGLES FOR VARIOUS FM ANTENNA HEIGHTS

H—Height in feet to Electrical center of antenna

D_h —Distance to horizon = $\sqrt{2H}$
(4/3 earth radius)

A_h —Depression angle to horizon = $\frac{.0216H}{D_h}$

The relationship $D = \frac{.0109 H}{A}$
gives approximate distances to intercept at various depression angles.

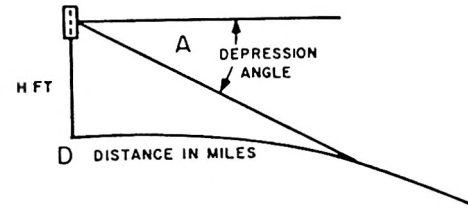

Height H in Feet	D_h A_h		Depression Angle																			
			0.5°	1°	1.5°	2°	2.5°	3°	3.5°	4°	4.5°	5°	6°	7°	8°	9°	10°	11°	12°	13°	14°	15°
			200	20.0	.216	4.6	2.21	1.45	1.07	0.86	0.71	0.61	0.54	0.48	0.43	0.36	0.31	0.27	0.24	0.22	0.20	0.18
300	24.5	.268	7.2	3.35	2.18	1.64	1.30	1.07	0.92	0.80	0.71	0.64	0.55	0.46	0.41	0.37	0.33	0.30	0.27	0.25	0.23	0.21
400	28.3	.304	9.9	4.49	2.90	2.18	1.75	1.42	1.24	1.06	0.94	0.86	0.73	0.62	0.54	0.49	0.46	0.40	0.36	0.33	0.31	0.29
500	31.6	.343	12.6	5.60	3.65	2.72	2.16	1.82	1.55	1.36	1.21	1.09	0.92	0.78	0.68	0.61	0.55	0.50	0.45	0.42	0.39	0.36
600	34.6	.375	16.0	6.81	4.8	3.61	2.64	2.15	1.86	1.63	1.42	1.31	1.09	0.92	0.81	0.73	0.65	0.59	0.54	0.50	0.46	0.43
700	37.4	.405	19.9	7.98	5.2	3.87	3.08	2.54	2.16	1.90	1.68	1.50	1.25	1.06	0.94	0.83	0.74	0.68	0.62	0.57	0.53	0.50
800	40.0	.435	24.2	9.2	5.9	4.49	3.52	2.89	2.50	2.17	1.90	1.75	1.45	1.22	1.05	0.97	0.86	0.78	0.72	0.67	0.61	0.58
900	42.4	.452	29.5	10.5	6.7	5.05	3.98	3.28	2.80	2.45	2.13	1.96	1.62	1.36	1.19	1.09	0.97	0.88	0.81	0.75	0.69	0.65
1000	45.0	.487	36.2	11.6	7.4	5.51	4.39	3.65	3.10	2.70	2.39	2.15	1.79	1.52	1.32	1.18	1.08	0.98	0.90	0.83	0.77	0.72
1200	49.0	.530	—	14.1	9.0	6.75	5.32	4.39	3.77	3.19	2.85	2.61	2.15	1.81	1.59	1.44	1.29	1.18	1.08	1.00	0.92	0.87
1400	53.0	.577	—	16.7	10.4	7.66	6.12	5.13	4.33	3.77	3.35	3.00	2.48	2.11	1.85	1.63	1.45	1.36	1.24	1.15	1.06	1.00
1600	56.6	.620	—	19.4	12.0	9.10	7.10	5.85	5.02	4.35	3.80	3.40	2.84	2.40	2.13	1.91	1.72	1.55	1.44	1.32	1.23	1.16
1800	60.0	.650	—	22.3	13.6	10.25	8.00	6.60	5.65	4.90	4.30	3.90	3.19	2.69	2.39	2.15	1.94	1.75	1.62	1.48	1.38	1.30
2000	63.2	.683	—	25.4	15.4	11.25	8.89	7.30	6.25	5.45	4.80	4.30	3.60	3.04	2.68	2.38	2.13	2.00	1.83	1.70	1.56	1.46
5000	100.0	1.080	—	—	42.9	29.5	22.80	18.75	15.85	13.75	12.10	10.90	9.01	7.75	6.73	6.00	5.40	4.90	4.50	4.15	3.84	3.60

Engineering Data

Approximate Distance to .05 MV/M (34 DBU) Contour

Antenna H.A.A.T. (in ft.)	.01 kW -20 dBK (in miles)	.1 kW -10 dBK (in miles)	.5 kW -3 dBK (in miles)	1 kW 0 dBK (in miles)	1.5 kW 1.8 dBK (in miles)	3 kW 4.8 dBK (in miles)	6 kW 7.8 dBK (in miles)	10 kW 10 dBK (in miles)	25 kW 14 dBK (in miles)	50 kW 17 dBK (in miles)	100 kW 20 dBK (in miles)
100	9.0	15.6	22.6	26.3	28.7	33.3	38.5	42.7	51.2	58.5	66.6
150	11.2	19.0	26.8	30.7	33.2	37.8	42.9	46.9	54.9	61.6	69.0
200	12.9	21.6	29.8	33.9	36.4	41.0	46.1	50.0	57.7	64.2	71.4
250	14.3	23.6	32.2	36.3	38.9	43.6	48.6	52.5	60.2	66.5	73.5
300	15.5	25.3	34.2	38.4	41.1	45.8	50.8	54.7	62.3	68.6	75.5
350	16.6	26.9	35.9	40.3	42.9	47.7	52.7	56.6	64.2	70.4	77.3
400	17.7	28.3	37.5	41.9	44.6	49.4	54.5	58.4	65.9	72.1	78.9
450	18.6	29.5	39.0	43.4	46.1	50.9	56.0	60.0	67.5	73.7	80.5
500	19.5	30.7	40.3	44.8	47.5	52.4	57.5	61.4	68.9	75.1	81.9
550	20.3	31.8	41.5	46.1	48.8	53.7	58.8	62.8	70.3	76.5	83.3
600	21.1	32.9	42.7	47.3	50.1	55.0	60.1	64.1	71.6	77.8	84.6
650	21.9	33.8	43.8	48.4	51.2	56.2	61.3	65.3	72.8	79.0	85.8
700	22.6	34.8	44.8	49.5	52.3	57.3	62.5	66.4	74.0	80.2	87.0
750	23.3	35.7	45.8	50.5	53.3	58.3	63.5	67.5	75.1	81.3	88.1
800	24.0	36.5	46.8	51.5	54.3	59.4	64.6	68.6	76.2	82.4	89.2
850	24.6	37.3	47.7	52.4	55.3	60.3	65.6	69.6	77.2	83.4	90.2
900	25.3	38.1	48.6	53.3	56.2	61.3	66.5	70.5	78.2	84.4	91.2
950	25.9	38.9	49.4	54.2	57.1	62.1	67.4	71.5	79.1	85.4	92.2
1000	26.4	39.6	50.2	55.0	57.9	63.0	68.3	72.3	80.0	86.3	93.1
1050	27.0	40.3	51.0	55.8	58.7	63.8	69.1	73.2	80.9	87.2	94.0
110Q	27.6	41.0	51.7	56.6	59.5	64.6	70.0	74.0	81.7	88.1	94.9
1150	28.1	41.7	52.4	57.3	60.3	65.4	70.7	74.8	82.6	88.9	95.8
1200	28.6	42.3	53.1	58.1	61.0	66.2	71.5	75.6	83.4	89.7	96.6
1250	29.1	43.0	53.8	58.8	61.7	66.9	72.2	76.4	84.1	90.5	97.4
1300	29.6	43.6	54.5	59.4	62.4	67.6	73.0	77.1	84.9	91.3	98.2
1350	30.1	44.1	55.1	60.1	63.1	68.3	73.7	77.8	85.6	92.0	99.0
1400	30.6	44.7	55.7	60.7	63.7	68.9	74.3	78.5	86.3	92.8	99.8
1450	31.0	45.3	56.3	61.3	64.3	69.6	75.0	79.2	87.0	93.5	100.5
1500	31.5	45.8	56.9	61.9	64.9	70.2	75.6	79.8	87.7	94.2	101.2
1550	31.9	46.3	57.5	62.5	65.5	70.8	76.3	80.4	88.4	94.9	101.9
1600	32.3	46.9	58.0	63.1	66.1	71.4	76.9	81.1	89.0	95.6	102.7
1650	32.8	47.4	58.6	63.6	66.7	72.0	77.5	81.7	89.7	96.2	103.3
1700	33.2	47.8	59.1	64.2	67.2	72.5	78.0	82.3	90.3	96.9	104.0
1750	33.6	48.3	59.6	64.7	67.7	73.1	78.6	82.8	90.9	97.5	104.7
1800	34.0	48.8	60.1	65.2	68.2	73.6	79.1	83.4	91.5	98.1	105.3
1850	34.4	49.2	60.6	65.7	68.7	74.1	79.7	84.0	92.1	98.7	106.0
1900	34.7	49.7	61.0	66.2	69.2	74.6	80.2	84.5	92.7	99.3	106.6
1950	35.1	50.1	61.5	66.6	69.7	75.1	80.7	85.0	93.2	99.9	107.2
2000	35.5	50.5	61.9	67.1	70.2	75.6	81.2	85.5	93.8	100.5	107.9
2050	35.8	50.9	62.4	67.5	70.6	76.0	81.7	86.0	94.3	101.1	108.5
2100	36.2	51.3	62.8	68.0	71.1	76.5	82.2	86.5	94.8	101.7	109.1
2150	36.5	51.7	63.2	68.4	71.5	77.0	82.6	87.0	95.4	102.2	109.7
2200	36.8	52.1	63.6	68.8	71.9	77.4	83.1	87.5	95.9	102.8	110.2
2250	37.2	52.5	64.0	69.2	72.3	77.8	83.5	88.0	96.4	103.3	110.8
2300	37.5	52.8	64.4	69.6	72.7	78.2	84.0	88.4	96.9	103.8	111.4
2350	37.8	53.2	64.8	70.0	73.1	78.6	84.4	88.9	97.4	104.4	112.0
2400	38.1	53.5	65.1	70.4	73.5	79.0	84.8	89.3	97.8	104.9	112.5
2450	38.4	53.9	65.5	70.7	73.9	79.4	85.2	89.7	98.3	105.4	113.1
2500	38.7	54.2	65.8	71.1	74.2	79.8	85.6	90.2	98.8	105.9	113.6
2550	39.0	54.5	66.2	71.4	74.6	80.2	86.0	90.6	99.2	106.4	114.2
2600	39.3	54.9	66.5	71.8	75.0	80.6	86.4	91.0	99.7	106.9	114.7
2650	39.6	55.2	66.8	72.1	75.3	80.9	86.8	91.4	100.1	107.4	115.2
2700	39.9	55.5	67.2	72.4	75.6	81.3	87.2	91.8	100.6	107.8	115.7
2750	40.1	55.8	67.5	72.8	76.0	81.6	87.5	92.2	101.0	108.3	116.3
2800	40.4	56.1	67.8	73.1	76.3	81.9	87.9	92.5	101.4	108.8	116.8
2850	40.7	56.3	68.1	73.4	76.6	82.3	88.3	92.9	101.9	109.2	117.3
2900	40.9	56.6	68.4	73.7	76.9	82.6	88.6	93.3	102.3	109.7	117.8
2950	41.2	56.9	68.6	74.0	77.2	82.9	88.9	93.6	102.7	110.2	118.3
3000	41.4	57.2	68.9	74.3	77.5	83.2	89.3	94.0	103.1	110.6	118.6

NOTE: H.A.A.T. is Height Above Average Terrain at Center of radiation.

Approximate Distance to .5 MV/M (54 DBU) Contour

Antenna H.A.A.T. (in ft.)	.01 kW -20 dBK (in miles)	.1 kW -10 dBK (in miles)	.5 kW -3 dBK (in miles)	1 kW 0 dBK (in miles)	1.5 kW 1.8 dBK (in miles)	3 kW 4.8 dBK (in miles)	6 kW 7.8 dBK (in miles)	10 kW 10 dBK (in miles)	25 kW 14 dBK (in miles)	50 kW 17 dBK (in miles)	100 kW 20 dBK (in miles)
100	2.9	5.1	7.6	9.0	9.9	11.7	13.8	15.6	19.3	22.6	26.3
150	3.5	6.3	9.4	11.2	12.3	14.5	17.0	19.0	23.2	26.8	30.7
200	4.0	7.3	10.9	12.9	14.1	16.6	19.3	21.6	26.0	29.8	33.9
250	4.5	8.1	12.1	14.3	15.7	18.3	21.2	23.6	28.3	32.2	36.3
300	4.9	8.9	13.2	15.5	17.0	19.8	22.9	25.3	30.2	34.2	38.4
350	5.3	9.6	14.2	16.6	18.2	21.1	24.3	26.9	31.9	35.9	40.3
400	5.7	10.3	15.1	17.7	19.3	22.3	25.6	28.3	33.4	37.5	41.9
450	6.1	10.9	15.9	18.6	20.3	23.4	26.8	29.5	34.7	39.0	43.4
500	6.4	11.5	16.7	19.5	21.2	24.5	28.0	30.7	36.0	40.3	44.8
550	6.7	12.0	17.5	20.3	22.1	25.4	29.0	31.8	37.2	41.5	46.1
600	7.0	12.6	18.2	21.1	23.0	26.3	30.0	32.9	38.3	42.7	47.3
650	7.3	13.1	18.9	21.9	23.8	27.2	30.9	33.8	39.4	43.8	48.4
700	7.6	13.6	19.5	22.6	24.5	28.1	31.8	34.8	40.4	44.8	49.5
750	7.8	14.0	20.2	23.3	25.3	28.9	32.7	35.7	41.3	45.8	50.5
800	8.1	14.5	20.8	24.0	26.0	29.6	33.5	36.5	42.2	46.8	51.5
850	8.4	14.9	21.4	24.6	26.7	30.4	34.3	37.3	43.1	47.7	52.4
900	8.6	15.3	21.9	25.3	27.3	31.1	35.1	38.1	43.9	48.6	53.3
950	8.8	15.8	22.5	25.9	28.0	31.7	35.8	38.9	44.8	49.4	54.2
1000	9.1	16.2	23.0	26.4	28.6	32.4	36.5	39.6	45.5	50.2	55.0
1050	9.3	16.6	23.5	27.0	29.2	33.1	37.2	40.3	46.3	51.0	55.8
1100	9.5	16.9	24.0	27.6	29.7	33.7	37.8	41.0	47.0	51.7	56.6
1150	9.7	17.3	24.5	28.1	30.3	34.3	38.5	41.7	47.7	52.4	57.3
1200	9.9	17.7	25.0	28.6	30.9	34.9	39.1	42.3	48.4	53.1	58.1
1250	10.1	18.0	25.5	29.1	31.4	35.4	39.7	43.0	49.0	53.8	58.7
1300	10.3	18.4	25.9	29.6	31.9	36.0	40.3	43.6	49.7	54.5	59.4
1350	10.5	18.7	26.4	30.1	32.4	36.5	40.8	44.1	50.3	55.1	60.1
1400	10.7	19.0	26.8	30.6	32.9	37.0	41.4	44.7	50.9	55.7	60.7
1450	10.9	19.4	27.2	31.0	33.4	37.6	41.9	45.3	51.5	56.3	61.3
1500	11.0	19.7	27.6	31.5	33.8	38.1	42.5	45.8	52.0	56.9	61.9
1550	11.2	20.0	28.0	31.9	34.3	38.5	43.0	46.3	52.6	57.5	62.5
1600	11.4	20.3	28.4	32.3	34.7	39.0	43.5	46.9	53.1	58.0	63.1
1650	11.6	20.6	28.8	32.8	35.2	39.5	44.0	47.4	53.6	58.6	63.6
1700	11.7	20.9	29.2	33.2	35.6	39.9	44.4	47.8	54.2	59.1	64.2
1750	11.9	21.2	29.6	33.6	36.0	40.4	44.9	48.3	54.7	59.6	64.7
1800	12.0	21.5	29.9	34.0	36.4	40.8	45.3	48.8	55.1	60.1	65.2
1850	12.2	21.7	30.3	34.4	36.8	41.2	45.8	49.2	55.6	60.6	65.7
1900	12.3	22.0	30.6	34.7	37.2	41.6	46.2	49.7	56.1	61.0	66.2
1950	12.5	22.3	31.0	35.1	37.6	42.0	46.6	50.1	56.5	61.5	66.6
2000	12.6	22.6	31.3	35.5	38.0	42.4	47.0	50.5	56.9	61.9	67.1
2050	12.8	22.8	31.6	35.8	38.3	42.8	47.4	50.9	57.4	62.4	67.5
2100	12.9	23.1	32.0	36.2	38.7	43.2	47.8	51.3	57.8	62.8	68.0
2150	13.1	23.3	32.3	36.5	39.1	43.6	48.2	51.7	58.2	63.2	68.4
2200	13.2	23.6	32.6	36.8	39.4	43.9	48.6	52.1	58.6	63.6	68.8
2250	13.3	23.8	32.9	37.2	39.7	44.3	48.9	52.5	59.0	64.0	69.2
2300	13.5	24.0	33.2	37.5	40.1	44.6	49.3	52.8	59.3	64.4	69.6
2350	13.6	24.3	33.5	37.8	40.4	45.0	49.7	53.2	59.7	64.8	70.0
2400	13.7	24.5	33.8	38.1	40.7	45.3	50.0	53.5	60.1	65.1	70.4
2450	13.8	24.7	34.1	38.4	41.0	45.6	50.3	53.9	60.4	65.5	70.7
2500	14.0	25.0	34.4	38.7	41.3	45.9	50.7	54.2	60.7	65.8	71.1
2550	14.1	25.2	34.6	39.0	41.6	46.2	51.0	54.5	61.1	66.2	71.4
2600	14.2	25.4	34.9	39.3	41.9	46.6	51.3	54.9	61.4	66.5	71.8
2650	14.3	25.6	35.2	39.6	42.2	46.9	51.6	55.2	61.7	66.8	72.1
2700	14.4	25.8	35.4	39.9	42.5	47.1	51.9	55.5	62.0	67.2	72.4
2750	14.5	26.0	35.7	40.1	42.8	47.4	52.2	55.8	62.3	67.5	72.8
2800	14.6	26.2	35.9	40.4	43.1	47.7	52.5	56.1	62.6	67.8	73.1
2850	14.8	26.4	36.2	40.7	43.3	48.0	52.8	56.3	62.9	68.1	73.4
2900	14.9	26.6	36.4	40.9	43.6	48.3	53.0	56.6	63.2	68.4	73.7
2950	15.0	26.8	36.7	41.2	43.9	48.5	53.3	56.9	63.5	68.6	74.0
3000	15.1	27.0	36.9	41.4	44.1	48.8	53.6	57.2	63.8	68.9	74.3

NOTE: H.A.A.T. Is Height Above Average Terrain at Center of radiation.

Engineering Data

Approximate Distance to 1 MV/M (60 DBU) Contour

Antenna H.A.A.T. (in ft.)	.01 kW -20 dBK (in miles)	.1 kW -10 dBK (in miles)	.5 kW -3 dBK (in miles)	1 kW 0 dBK (in miles)	1.5 kW 1.8 dBK (in miles)	3 kW 4.8 dBK (in miles)	6 kW 7.8 dBK (in miles)	10 kW 10 dBK (in miles)	25 kW 14 dBK (in miles)	50 kW 17 dBK (in miles)	100 kW 20 dBK (in miles)
100	2.1	3.6	5.4	6.4	7.1	8.4	9.9	11.2	14.0	16.5	19.3
150	2.5	4.4	6.7	7.9	8.8	10.4	12.3	13.9	17.2	20.0	23.2
200	2.9	5.1	7.7	9.2	10.1	12.0	14.2	15.9	19.5	22.6	26.0
250	3.2	5.7	8.6	10.2	11.3	13.4	15.7	17.6	21.4	24.7	28.3
300	3.5	6.3	9.4	11.2	12.3	14.5	17.0	19.0	23.1	26.5	30.2
350	3.8	6.8	10.2	12.0	13.3	15.6	18.2	20.3	24.5	28.1	31.9
400	4.0	7.2	10.9	12.8	14.1	16.6	19.3	21.5	25.9	29.5	33.4
450	4.2	7.7	11.5	13.6	14.9	17.5	20.3	22.6	27.1	30.8	34.8
500	4.4	8.1	12.1	14.3	15.7	18.3	21.3	23.6	28.2	32.0	36.0
550	4.7	8.5	12.7	15.0	16.4	19.1	22.2	24.6	29.3	33.1	37.2
600	4.9	8.9	13.3	15.6	17.1	19.9	23.0	25.5	30.2	34.2	38.3
650	5.0	9.3	13.8	16.2	17.8	20.6	23.8	26.3	31.2	35.2	39.4
700	5.2	9.6	14.3	16.8	18.4	21.3	24.6	27.1	32.1	36.1	40.4
750	5.4	10.0	14.8	17.4	19.0	22.0	25.3	27.9	32.9	37.0	41.3
800	5.6	10.3	15.3	17.9	19.6	22.6	26.0	28.7	33.8	37.9	42.3
850	5.7	10.6	15.7	18.4	20.1	23.3	26.7	29.4	34.6	38.7	43.1
900	5.9	10.9	16.2	18.9	20.7	23.9	27.3	30.1	35.3	39.5	44.0
950	6.0	11.2	16.6	19.4	21.2	24.4	28.0	30.8	36.1	40.3	44.8
1000	6.2	11.5	17.0	19.9	21.7	25.0	28.6	31.4	36.8	41.1	45.6
1050	6.3	11.8	17.4	20.4	22.2	25.6	29.2	32.0	37.4	41.8	46.3
1100	6.4	12.1	17.8	20.8	22.7	26.1	29.8	32.6	38.1	42.5	47.0
1150	6.6	12.4	18.2	21.2	23.1	26.6	30.3	33.2	38.8	43.2	47.7
1200	6.7	12.6	18.6	21.7	23.6	27.1	30.9	33.8	39.4	43.8	48.4
1250	6.8	12.9	19.0	22.1	24.0	27.6	31.4	34.4	40.0	44.4	49.1
1300	6.9	13.2	19.3	22.5	24.5	28.1	31.9	34.9	40.6	45.1	49.7
1350	7.1	13.4	19.7	22.9	24.9	28.5	32.4	35.4	41.1	45.6	50.3
1400	7.2	13.6	20.0	23.3	25.3	29.0	32.9	36.0	41.7	46.2	50.9
1450	7.3	13.9	20.4	23.7	25.7	29.4	33.4	36.5	42.2	46.8	51.5
1500	7.4	14.1	20.7	24.0	26.1	29.9	33.9	37.0	42.8	47.3	52.1
1550	7.5	14.3	21.0	24.4	26.5	30.3	34.3	37.4	43.3	47.9	52.6
1600	7.6	14.6	21.4	24.8	26.9	30.7	34.8	37.9	43.8	48.4	53.2
1650	7.7	14.8	21.7	25.1	27.3	31.1	35.2	38.4	44.3	48.9	53.7
1700	7.8	15.0	22.0	25.5	27.6	31.5	35.6	38.8	44.7	49.4	54.2
1750	7.9	15.2	22.3	25.8	28.0	31.9	36.1	39.2	45.2	49.9	54.7
1800	8.0	15.4	22.6	26.1	28.3	32.3	36.5	39.7	45.6	50.3	55.2
1850	8.1	15.6	22.9	26.5	28.7	32.7	36.9	40.1	46.1	50.8	55.6
1900	8.1	15.8	23.2	26.8	29.0	33.0	37.3	40.5	46.5	51.2	56.1
1950	8.2	16.0	23.4	27.1	29.3	33.4	37.6	40.9	46.9	51.7	56.5
2000	8.3	16.2	23.7	27.4	29.7	33.7	38.0	41.3	47.3	52.1	57.0
2050	8.4	16.4	24.0	27.7	30.0	34.1	38.4	41.7	47.7	52.5	57.4
2100	8.5	16.6	24.2	28.0	30.3	34.4	38.7	42.0	48.1	52.9	57.8
2150	8.5	16.8	24.5	28.3	30.6	34.8	39.1	42.4	48.5	53.3	58.2
2200	8.6	16.9	24.8	28.6	30.9	35.1	39.4	42.7	48.9	53.7	58.6
2250	8.7	17.1	25.0	28.9	31.2	35.4	39.8	43.1	49.3	54.1	59.0
2300	8.8	17.3	25.3	29.1	31.5	35.7	40.1	43.4	49.6	54.4	59.4
2350	8.8	17.5	25.5	29.4	31.8	36.0	40.4	43.8	50.0	54.8	59.7
2400	8.9	17.6	25.7	29.7	32.1	36.3	40.8	44.1	50.3	55.1	60.1
2450	9.0	17.8	26.0	29.9	32.3	36.6	41.1	44.4	50.6	55.5	60.4
2500	9.0	18.0	26.2	30.2	32.6	36.9	41.4	44.7	51.0	55.8	60.8
2550	9.1	18.1	26.5	30.5	32.9	37.2	41.7	45.1	51.3	56.1	61.1
2600	9.1	18.3	26.7	30.7	33.2	37.5	42.0	45.4	51.6	56.5	61.4
2650	9.2	18.4	26.9	30.9	33.4	37.8	42.3	45.7	51.9	56.8	61.8
2700	9.3	18.6	27.1	31.2	33.7	38.0	42.5	45.9	52.2	57.1	62.1
2750	9.3	18.7	27.3	31.4	33.9	38.3	42.8	46.2	52.5	57.4	62.4
2800	9.4	18.9	27.6	31.7	34.2	38.6	43.1	46.5	52.8	57.7	62.7
2850	9.4	19.0	27.8	31.9	34.4	38.8	43.4	46.8	53.1	58.0	63.0
2900	9.5	19.2	28.0	32.1	34.6	39.1	43.6	47.1	53.4	58.2	63.2
2950	9.5	19.3	28.2	32.4	34.9	39.3	43.9	47.3	53.6	58.5	63.5
3000	9.6	19.5	28.4	32.6	35.1	39.6	44.1	47.6	53.9	58.8	63.8

NOTE: H.A.A.T. is Height Above Average Terrain at Center of radiation.

Approximate Distance to 3.16 MV/M (70 DBU) Contour

Antenna H.A.A.T. (In ft.)	.01 kW -20 dBK (in miles)	.1 kW -10 dBK (in miles)	.5 kW -3 dBK (in miles)	1 kW 0 dBK (in miles)	1.5 kW 1.8 dBK (in miles)	3 kW 4.8 dBK (in miles)	6 kW 7.8 dBK (in miles)	10 kW 10 dBK (in miles)	25 kW 14 dBK (in miles)	50 kW 17 dBK (in miles)	100 kW 20 dBK (in miles)
100	1.2	2.1	3.0	3.6	4.0	4.7	5.6	6.4	8.0	9.5	11.2
150	1.5	2.5	3.7	4.4	4.9	5.8	7.0	7.9	10.0	11.8	13.9
200	1.8	2.9	4.3	5.1	5.7	6.8	8.1	9.2	11.5	13.6	15.9
250	1.9	3.2	4.8	5.7	6.3	7.6	9.0	10.2	12.8	15.0	17.6
300	2.1	3.5	5.2	6.3	6.9	8.3	9.9	11.2	13.9	16.3	19.0
350	2.2	3.8	5.7	6.8	7.5	9.0	10.6	12.0	15.0	17.5	20.3
400	2.3	4.0	6.1	7.2	8.0	9.6	11.4	12.8	15.9	18.6	21.5
450	2.4	4.2	6.4	7.7	8.5	10.2	12.0	13.6	16.8	19.5	22.6
500	2.5	4.4	6.8	8.1	9.0	10.7	12.7	14.3	17.6	20.5	23.6
550	2.6	4.7	7.1	8.5	9.4	11.2	13.3	15.0	18.4	21.3	24.6
600	2.6	4.9	7.4	8.9	9.9	11.7	13.9	15.6	19.1	22.2	25.5
650	2.7	5.0	7.7	9.3	10.3	12.2	14.4	16.2	19.8	22.9	26.3
700	2.8	5.2	8.0	9.6	10.7	12.7	14.9	16.8	20.5	23.7	27.1
750	2.8	5.4	8.3	10.0	11.0	13.1	15.4	17.4	21.2	24.4	27.9
800	2.9	5.6	8.6	10.3	11.4	13.5	15.9	17.9	21.8	25.1	28.7
850	2.9	5.7	8.9	10.6	11.8	14.0	16.4	18.4	22.4	25.8	29.4
900	3.0	5.9	9.1	10.9	12.1	14.4	16.9	18.9	23.0	26.4	30.1
950	3.0	6.0	9.4	11.2	12.5	14.7	17.3	19.4	23.6	27.0	30.8
1000	3.1	6.2	9.6	11.5	12.8	15.1	17.8	19.9	24.1	27.6	31.4
1050	3.1	6.3	9.9	11.8	13.1	15.5	18.2	20.4	24.6	28.2	32.0
1100	3.2	6.4	10.1	12.1	13.4	15.9	18.6	20.8	25.2	28.8	32.6
1150	3.2	6.6	10.3	12.4	13.7	16.2	19.0	21.2	25.7	29.3	33.2
1200	3.3	6.7	10.5	12.6	14.0	16.5	19.4	21.7	26.2	29.9	33.8
1250	3.3	6.8	10.8	12.9	14.3	16.9	19.8	22.1	26.6	30.4	34.4
1300	3.3	6.9	11.0	13.2	14.6	17.2	20.1	22.5	27.1	30.9	34.9
1350	3.3	7.1	11.2	13.4	14.8	17.5	20.5	22.9	27.6	31.4	35.4
1400	3.4	7.2	11.4	13.6	15.1	17.8	20.9	23.3	28.0	31.9	36.0
1450	3.4	7.3	11.6	13.9	15.4	18.1	21.2	23.7	28.4	32.3	36.5
1500	3.4	7.4	11.8	14.1	15.6	18.5	21.6	24.0	28.9	32.8	37.0
1550	3.5	7.5	11.9	14.3	15.9	18.7	21.9	24.4	29.3	33.2	37.4
1600	3.5	7.6	12.1	14.6	16.1	19.0	22.2	24.8	29.7	33.7	37.9
1650	3.5	7.7	12.3	14.8	16.4	19.3	22.6	25.1	30.1	34.1	38.4
1700	3.5	7.8	12.5	15.0	16.6	19.6	22.9	25.5	30.5	34.5	38.8
1750	3.5	7.9	12.7	15.2	16.8	19.9	23.2	25.8	30.9	34.9	39.2
1800	3.5	8.0	12.8	15.4	17.1	20.1	23.5	26.1	31.2	35.3	39.7
1850	3.6	8.1	13.0	15.6	17.3	20.4	23.8	26.5	31.6	35.7	40.1
1900	3.6	8.1	13.2	15.8	17.5	20.7	24.1	26.8	32.0	36.1	40.5
1950	3.6	8.2	13.3	16.0	17.7	20.9	24.4	27.1	32.3	36.5	40.9
2000	3.6	8.3	13.5	16.2	17.9	21.2	24.7	27.4	32.6	36.9	41.3
2050	3.6	8.4	13.6	16.4	18.2	21.4	24.9	27.7	33.0	37.2	41.7
2100	3.6	8.5	13.8	16.6	18.4	21.6	25.2	28.0	33.3	37.6	42.0
2150	3.6	8.5	13.9	16.8	18.6	21.9	25.5	28.3	33.6	37.9	42.4
2200	3.6	8.6	14.1	16.9	18.8	22.1	25.7	28.6	34.0	38.3	42.7
2250	3.6	8.7	14.2	17.1	19.0	22.3	26.0	28.9	34.3	38.6	43.1
2300	3.6	8.8	14.4	17.3	19.2	22.6	26.3	29.1	34.6	38.9	43.4
2350	3.6	8.8	14.5	17.5	19.3	22.8	26.5	29.4	34.9	39.3	43.8
2400	3.6	8.9	14.6	17.6	19.5	23.0	26.8	29.7	35.2	39.6	44.1
2450	3.6	9.0	14.8	17.8	19.7	23.2	27.0	29.9	35.5	39.9	44.4
2500	3.6	9.0	14.9	18.0	19.9	23.4	27.2	30.2	35.8	40.2	44.7
2550	3.6	9.1	15.0	18.1	20.1	23.7	27.5	30.5	36.0	40.5	45.1
2600	3.6	9.1	15.2	18.3	20.3	23.9	27.7	30.7	36.3	40.8	45.4
2650	3.6	9.2	15.3	18.4	20.4	24.1	27.9	30.9	36.6	41.1	45.7
2700	3.6	9.3	15.4	18.6	20.6	24.3	28.2	31.2	36.9	41.3	45.9
2750	3.6	9.3	15.5	18.7	20.8	24.5	28.4	31.4	37.1	41.6	46.2
2800	3.6	9.4	15.6	18.9	20.9	24.7	28.6	31.7	37.4	41.9	46.5
2850	3.6	9.4	15.8	19.0	21.1	24.8	28.8	31.9	37.6	42.2	46.8
2900	3.6	9.5	15.9	19.2	21.3	25.0	29.0	32.1	37.9	42.4	47.1
2950	3.6	9.5	16.0	19.3	21.4	25.2	29.3	32.4	38.1	42.7	47.3
3000	3.6	9.6	16.1	19.5	21.6	25.4	29.5	32.6	38.4	42.9	47.6

NOTE: H.A.A.T. is Height Above Average Terrain at Center of radiation.

**Continental's Customer Service . . .
*The Industry's Best!***

Call Anytime, Day Or Night.

**Main Offices:
(214) 381-7161**

**Parts:
(214) 388-3737**

**Engineering Service:
(214) 388-5800**

Telex: 73-398

FAX: (214) 381-4949

varian 

continental electronics division

4212 South Buckner Blvd., PO Box 270879
Dallas, Texas 75227 Ph: (214) 381-7161





Broadcast Products, Sales & Service

BROADCAST PRODUCTS

AMPLIFIERS, AUDIO

Crown
JBL/UREI
Logitek
Symetrix

AMPLIFIERS, DISTRIBUTION

ATI
Radio Systems
LPB
Micro-Trak
Logitek

ANTENNAS

ERI
Jampro
DB Products
Mark Products
Scala
Shively

AUDIO PROCESSORS

C.R.L.
DBX
Eventide
Aphex
Moseley
Modulation Sciences
Orban
Texar

AUDIO ROUTING SWITCHES

Ramko
Gentner
Logitek
Moseley

CARTRIDGE STORAGE RACKS

ABCO
Micro-Trak
Ruslang
Fidelipac

C-D PLAYERS

Studer/Revox
Technics

CLOCKS

Dayton
G.E.
E.S.E.
Logitek

COAXIAL CABLE & ACCESS.

Andrew
Cablewave
Dielectric Products
Myat

COAXIAL SWITCHES

Dielectric Products
Delta
MCI
Coaxial Dynamics

COAXIAL PATCH PANELS

Dielectric Products
ERI
Myat
Comark

COMBINERS

Dielectric Products
Celwave
Comark
ERI
Shively

CONSOLES

Autogram
Auditronics
L.P.B.
Radio Systems
Logitek
Howe

DISTRIBUTION AMPS.

ATI
Radio Systems
Micro-Trak
Logitek

DUMMY LOADS, R.F.

Altronic
Electro-Impulse
Continental
Bird
Coaxial Dynamics

EBS EQUIPMENT

Gorman-Redlich
T.F.T.

EQUALIZERS

D.B.X.
Orban
Symetrix
U.R.E.I.

FILTERS

E.R.I.
Dielectric Products
Celwave
Micro Communications

FURNITURE

Grinnan
Radio Systems
Micro-Trak
Ruslang

HEADPHONES

A.K.G.
Sennheiser

ISOLATION TRANSFORMERS

E.R.I.
Moseley

MICROPHONE

A.K.G.
Electro-Voice
Audio-Technica
Shure
Sennheiser

MICROPHONE ACCESSORIES

Atlas
Luxo
O.C. White

MONITORS, AM/FM

Belar
T.F.T.
Potomac
Delta
Q.E.I.
Gorman-Redlich

NOISE REDUCTION EQUIPMENT

D.B.X.
Dolby

PATCH PANELS (Audio)

A.D.C.
Gentner
Trimm

A/C PHASE CONVERTERS

Phasemaster

PHONO CARTRIDGE

Audio Technica
Shure
Stanton

PREAMPLIFIERS (Phono)

ATI
Radio Systems
Logitek
Russco
Micro-Trak
Shure
Stanton

RACK CABINETS

Continental
Soundolier
Emcor

RECORDERS (Cartridge)

Audi-Cord
Fidelipac
B.E.
Otari

RECORDERS (Reel to Reel)

Otari
Studer/Revox
Tascam

RECORDERS (Cassette)

Revox
Tascam
Technics

RECORDERS (DAT)

REMOTE CONTROL SYSTEMS

Advanced Micro-Dynamics
Delta
Gentner
Moseley
Potomac
T.F.T.

REMOTE BROADCAST AMPLIFIERS

Gentner
Russco
Shure
Telfax
Zercom

REMOTE PICK-UP TRANSMITTERS

Marti
Moseley
T.F.T.

S.C.A. EQUIPMENT

C.R.L.
Modulation Sciences
Moseley
BTC

SPEAKERS

Electro-Voice
J.B.L.

STL SYSTEMS

Marti
Moseley
T.F.T.

STEREO GENERATORS

Dorrough
C.R.L.
Orban

SURGE PROTECTORS

Dale
L.E.A. Dynatech
CPS Electronics
Innovative Technologies
Control Concepts

TELEPHONE INTERFACE UNITS

Gentner
Tellabs
Symetrix

TEST EQUIPMENT

Audio Precision
Delta
Potomac
Tektronix

TOWERS

Central
Pi-Rod
Rohn
Stainless
Utility
World
Magnum

TRANSMISSION LINE AND ACCESS.

Andrew
Cablewave
Dielectric Products
Myat

TURNTABLES

Russco
Technics

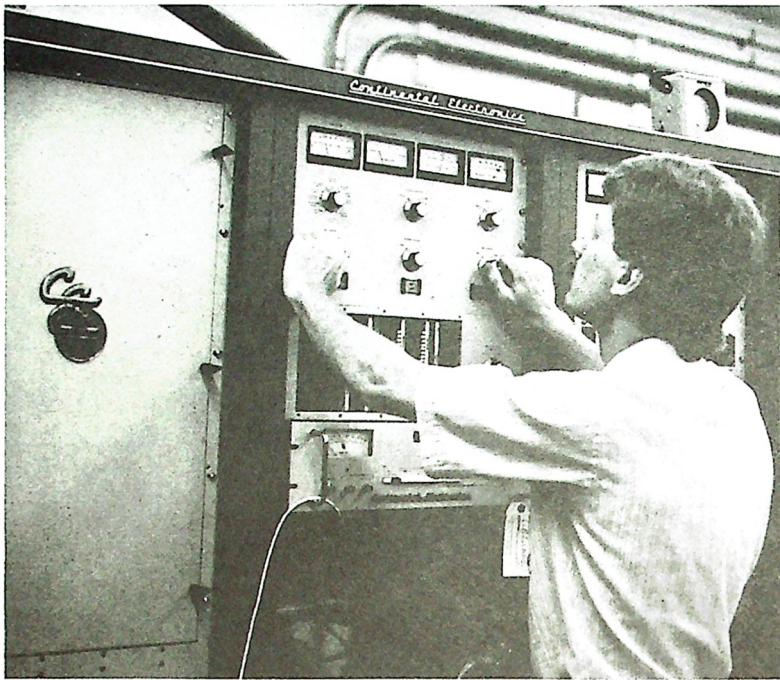

Sales and Service for Continental Electronics Broadcast Transmitters

Continental broadcast equipment and existing Collins radio transmitters are serviced by a world-wide Continental field support and marketing group headquartered in Dallas, Texas.

All products and prices in this catalog are subject to change without notice. For price or delivery information, contact your Continental representative.

10 District Managers handle sales for stations in the United States.

Sales to stations in Canada, Hawaii and Puerto Rico are handled from the home office in Dallas, Texas.

International sales are handled thru local sales representatives.

E.L. King, Manager
Marketing

W. Rice, Manager
Domestic Broadcast Marketing

D.M. Russell, Manager
International Marketing

Continental Electronics offers parts and engineering service for all Continental and Collins radio broadcast equipment 24-hours a day.

You can phone our service numbers day or night:

(214) 388-3737—Parts

(214) 388-5800—Service

Fax: (214) 381-4949

Telex: 73-398

Cable: CONTRONICS

Continental Electronics
a Division of Varian Associates, Inc.
4212 South Buckner Boulevard
P.O. Box 270879
Dallas, Texas 75227
Ph: (214) 381-7161

DOMESTIC DISTRICT MANAGERS

1

West

Ken Perkins
7846 S. Centaur Dr.
Evergreen, CO 80439
(303) 670-1049

2

Northeast

R. Clifford Rogers
P.O. Box 157
Schroon Lake, NY 12870
(518) 532-7488

3

Southeast

Don Crain
P.O. Box 355
Inman, SC 29349
(803) 599-1819

4

Southeast

Dave Hultsman
P.O. Box 26509
Birmingham, AL 35226
(205) 822-1078

5

Midwest

John D. Abdnour
P.O. Box 575
Streator, IL 61364
(815) 672-8585

6

Billy R. Emery
13783 Hanover Way
Apple Valley, MN 55124
(612) 431-1313

7

Barry Ariaz
P.O. Box 2117
Hendersonville, TN 37077
(615) 822-0256

8

Southwest

Steve H. Schott
P.O. Box 862008
Plano, TX 75086
(214) 423-3644

9

Northwest

Tom Cauthers
13333 S.E. Marsh Road
Sandy, OR 97055
(503) 668-9312

10

Marvin Steelman
3901 Rexford Court
Modesto, CA 95356
(209) 523-7505

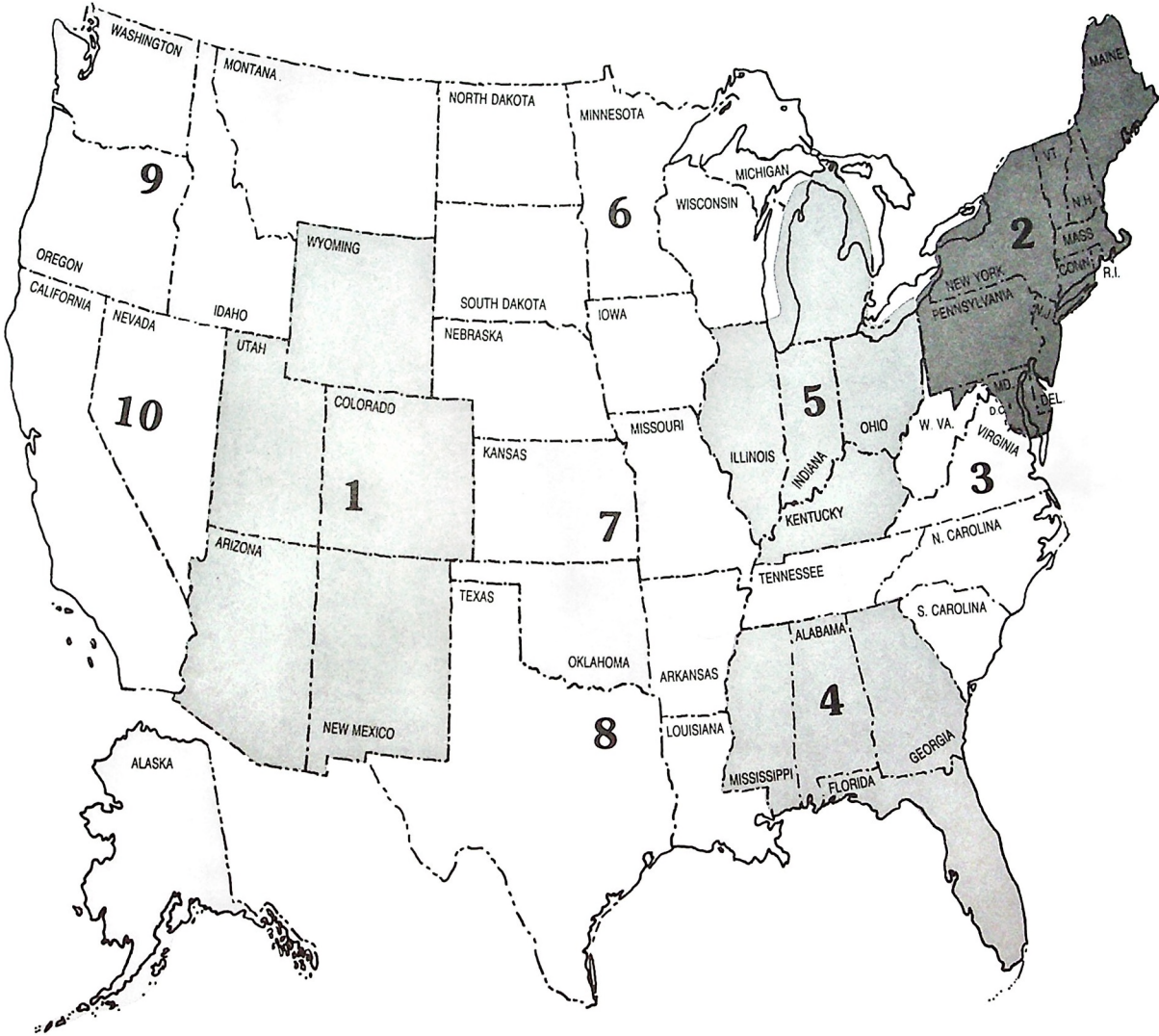

Sales & Service International

INTERNATIONAL SALES REPRESENTATIVES

AUSTRALIA

Varian Pty. Ltd.
Suite 6/81
Frenchs Forest Road (East)
Frenchs Forest 2086, Australia
Telex: (790) 24503
Phone: 61 + 2 + 451-9133
Fax: 61 + 2 + 452-2600

BANGLADESH

Shell Co.
Akbari House
9H, Motijheel Commercial Area
Dhaka-2, Bangladesh
Telex: (950) 642709 SKAN BJ
Phone: 880 + 2 + 255464

BRAZIL

Larex Eletronica, Ltda.
Av. N.S. Copacabana, 195
Grupo 1301
Rio de Janeiro 22020, Brazil
Telex: (391) 2121616 LREX BR
Phone: 55 + 21 + 542-4343
Fax: 55 + 21 + 541-4448

CHILE

Lensa S.A.
David Arellano 1872
Casilla 50920
Santiago, Chile
Telex: (392) 241123
Phone: 56 + 2 + 773054
Fax: 56 + 2 + 771310

CHINA, REPUBLIC OF (TAIWAN)

Heighten Corporation
Taipei, Taiwan 104, ROC.
Telex: (785) 21472 HEIGHTEN
Phone: 886 + 2 + 503-9916
Fax: 886 + 2 + 505-7427

COLOMBIA

Auditron, Ltda.
Apartado Aereo 58103
Bogota, Colombia, S.A.
Telex: (396) 43415
Phone: 57 + 1 + 746110
Fax: 57 + 1 + 216-5664

EGYPT

Electrical & Telecommunications
Engineering
5, Kasr El Nil
Cairo, Egypt
Telex: (927) 93915 ETRSAS UN
Phone: 20 + 2 + 750755/750683

EUROPE, ALGERIA, LIBYA, MOROCCO, TUNISIA AND NORTH AFRICA

Eurotech Marketing (Overseas) Ltd.
Avenue De La Tanche 2
B-1160 Brussels, Belgium
Telex: (846) 25387 AVVAL B
Phone: 32 + 2 + 674-5239

GREECE

Greek Enterprises Ltd.
136 Marathonodromou Str.
GR-151 251 25 Maroussi
Athens, Greece
Telex: (863) 223905
Phone: 30 + 1 + 802-1903
Fax: 30 + 1 + 672-5466

ICELAND

G. Helgason & Melsted, Ltd.
P.O. Box 5500
125 Reykjavik, Iceland
Telex: (858) 2145
Phone: 354 + 1 + 62 30 40

INDIA

Varian International AG
7, Community Centre
Basant Lok
Vasant, Vihar
New Delhi 110 057, India
Telex: (953) 031-62863 VAR IN
Phone: 91 + 11 + 67 37 16

ISRAEL

Rapac Electronics Ltd.
P.O. Box 18053
Tel-Aviv 69513, Israel
Telex: (922) 33528
Phone: 972 + 3 + 477115/6/7/8/9
Fax: 972 + 3 + 493272

JAMAICA

Comtron Jamaica Ltd.
9 Dumbarton Avenue
P.O. Box 485
Kingston 10
Jamaica, West Indies
Telex: (381) 2106 ELCOM JA
Phone: 809 + 926-4386

JORDAN

W. R. Abdul-Hadi & Co.
P.O. Box 925292
Amman, Jordan
Telex: (925) 21266 MEKANO JO
Phone: 962 + 6 + 669631
Fax: 962 + 6 + 605251

KOREA

Sama Trading Corporation
C.P.O. Box 2447
Seoul, Korea
Telex: (787) 26375 SAMATRA
Phone: 82 + 2 + 733-9336
Fax: 82 + 2 + 733-8461

KUWAIT

KUWAITTEL, a Division of Office
Organization Center Ltd.
P.O. Box Safat, 270
Kuwait, State of Kuwait
Telex: (959) 22247/44395 MATIN KT
Phone: 965 + 244-5111
Fax: 965 + 241-9296

MOROCCO

Sicotel S. A.
Complexe des Habous
Tours C, Avenue des FAR
Casablanca 01, Morocco
Telex: (933) 27604 M
Phone: 212 + 31 22 70

NETHERLANDS ANTILLES

Industrial Electronics (Antilles) N.V.
Centro Comercial Antilia 1
Curacao, Netherlands Antilles
Telex: (384) 1125 INDELNA
Phone: 599 + 9 + 70352 & 70353
Fax: 599 + 9 + 78979

NEW ZEALAND

Pacific Communications Systems Ltd.
Box 33-619 Takapuna
Auckland 9, New Zealand
Telex: (791) NZ 60513 PCS TARD
Phone: 64 + 9 + 444-0971
Fax: 64 + 9 + 444-0639

OMAN

Suhail & Saud Bahwan
P.O. Box 169
Muscat, Sultanate of Oman
Telex: (926) 3724 or 3585
Phone: 968 + 793741
Fax: 968 + 797169

PAKISTAN

The Modern Trading Company
P.O. Box 12645
Karachi-2904, Pakistan
Telex: (952) 25236 ASIL PK
Phone: 92 + 21 + 440188

PARAGUAY

Latourrette & Parini S.A.C.
Casilla De Correo 1129
Asuncion, Paraguay
Telex: (399) 717 PY TWYN
Phone: 595 + 21 + 201-231 & 291-393

PERU

Fernando Ezeta T. SRL.
Casilla 3061
Lima 1, Peru
Telex: (394) 25811 PE SULCOSA
Phone: 51 + 14 + 45-2335

PORTUGAL

Ondex-Telecomunicacoes e
Electronica, Lda.
Avenida 24 De Julho, 132
1300 Lisbon, Portugal
Telex: (832) 65841 ONDEX P
Phone: 351 + 1 + 60 90 59
Fax: 351 + 1 + 66 56 26

SAUDI ARABIA

Wadaan Trading and Contracting
Company
Al-Sanie Bldg., Batha
P.O. Box 1370
Riyadh, Saudi Arabia
Telex: (928) 402134 WADAAN
Phone: 966 + 1 + 465-0342
Fax: 966 + 1 + 464-5502

SINGAPORE

Crow Broadcast Equipment (PTE) Ltd
1302 Lorong 1, Toa Payoh
#06-13 Siong Hoe Industrial Bldg.
Singapore 1231, Republic of Singapore
Telex: (786) RS 37708 CROWBD
Phone: 65 + 259-9216
Fax: 65 + 258-7996

SOUTHERN AFRICA

Communications Technology
Broadcasting (Pty.) Ltd.
P.O. Box 1785
Benoni 1500, S. Africa
Telex: (960) 4-27020 S.A
Phone: 27 + 11 + 422-3108/422-3109
Fax: 27 + 11 + 845-4124

SPAIN

Continental Broadcast S.A.
Calle Alfonso Pena, 15
28022 Madrid, Spain
Telex: (831) 48257 ITAM E
Phone: 34 + 1 + 205-3076
Fax: 34 + 1 + 747-7507

SRI LANKA

Colombo Agencies Limited
300-304 Galle Road
Colombo 3, Sri Lanka
Telex: (954) 22063
Phone: 94 + 1 + 573551/2 & 57395/6
Fax: 94 + 1 + 575394

THAILAND

Siam Teltech Company Ltd.
75 Soi Rubia, Sunkhumvit 42 Road
G.P.O. Box 2718
Bangkok 10110, Thailand
Telex: (788) 82631 WHITCO TH
Phone: 66 + 2 + 390-2445
Fax: 66 + 2 + 381-1525

TRINIDAD & TOBAGO

Borde Communications,
Division of NELCO Engineering Ltd.
Valsayn Road, Curepe
P.O. Box 897
Port of Spain, Trinidad
Telex: (387) 24461
Phone: 1 + 809 + 663-2087
Fax: 1 + 809 + 645-3352

URUGUAY

Farrell & Boix Ltda.
General Caraballo 1134
Montevideo, Uruguay
Telex: (398) UY 22356
Phone: (598)(2)23.38.46

VENEZUELA

Corporation Electronica S.A.
Apartado Correos 60.856
Caracas, Venezuela
Telex: (395) 27876 CPBTH VE
Phone: 58 + 2 + 322765 & 313479

ZIMBABWE

Martwell Electronics (Private) Ltd
P.O. Box 11737
Harare, Zimbabwe
Telex: (987) 22649 MARTEL ZWG
Phone: 263 + 4 + 793578

Notes



varian ^{VA}

continental electronics division

P.O. BOX 270879 DALLAS, TEXAS 75227 (214) 381-7161

PROPOSAL NUMBER: E- _____

DATE OF PROPOSAL: _____

If Buyer does not have a current, active account with Continental, the information provided below by the Buyer will assure correct, prompt processing and becomes part of the conditions of this Continental Proposal.

1. FCC LISTING OF BUYER NAME AND ADDRESS

2. TYPE OF BUSINESS: PROPRIETORSHIP PARTNERSHIP CORPORATION

3. NAMES OF PROPRIETOR, PARTNERS, OR CORPORATE OFFICERS	TITLE	% OWNERSHIP
_____	_____	_____
_____	_____	_____
_____	_____	_____

4. COMPANY BANK REFERENCE: _____
ADDRESS: _____

5. OWNER'S BANK REFERENCE AND ADDRESS (LIST IN ORDER OF OWNERS LISTED ABOVE):

6. NAME AND ADDRESS OF PERSON TO RECEIVE ALL CORRESPONDENCE REGARDING ORDER:

7. REQUESTED SHIPMENT DATE:
TRANSMITTER: _____ OTHER: _____
SHIPPING ADDRESS:
STUDIO: _____ TRANSMITTER: _____

8. SHIP VIA: Normal shipment will by by Air Ride van unless otherwise specified.
Other method: _____

9. FINAL C.P. RECEIVED: YES NO

10. ATTACH A SIGNED CURRENT FINANCIAL STATEMENT INCLUDING A BALANCE SHEET AND A PROFIT & LOSS STATEMENT. IF A NEW COMPANY, ATTACH A BEGINNING BALANCE SHEET AND A SALES & EXPENSE ANALYSIS.

VARIAN
CONTINENTAL ELECTRONICS DIVISION
(“Seller”)
TERMS AND CONDITIONS OF SALE

1. CUSTOMER'S TERMS AND CONDITIONS

Seller desires to provide its Customers with prompt and efficient service. However, to negotiate individually the terms and conditions of each sales contract would substantially impair Seller's ability to provide such service. Accordingly, Products and services furnished by Seller are sold only on the terms and conditions stated herein. Notwithstanding any terms or conditions on Customer's order, Seller's performance of any contract is expressly made conditional on Customer's agreement to Seller's Terms and Conditions of Sale unless otherwise specifically agreed to in writing by Seller. In the absence of such agreement, commencement of performance and/or delivery shall be for Customer's convenience only and shall not be deemed or construed to be acceptance of Customer's terms and conditions, or any of them. If a contract is not earlier formed by mutual agreement in writing, acceptance of any Product or service shall be deemed acceptance of the terms and conditions stated herein. All contracts for the sale of Products shall be construed under and governed by the law of the location of Seller's manufacturing plant from which the Products are shipped.

2. ORDERS

All orders for non-catalog Products not responding to a quotation issued by Seller shall be subject to acceptance by Seller only at its plant.

3. QUOTATIONS AND PRICES

All quotations are subject to the terms and conditions stated herein as well as any additional terms and conditions that may appear on the face hereof. In the case of a conflict between the terms and conditions stated herein and those appearing on the face hereof, the latter shall control.

Seller's prices and quotations are subject to the following:

- (a) All published prices are subject to change without notice.
- (b) UNLESS OTHERWISE SPECIFIED IN WRITING, ALL QUOTATIONS ARE FIRM FOR, AND EXPIRE, SIXTY (60) DAYS AFTER DATE THEREOF AND CONSTITUTE OFFERS; provided that, budgetary quotations and estimates are for preliminary information only and shall neither constitute offers, nor impose any responsibility or liability upon Seller.
- (c) Unless otherwise stated in writing by Seller, all prices quoted shall be exclusive of transportation, insurance, taxes (including, without limitation, any sales, use or similar tax, and any tax levied on or assessed to Seller after Product delivery by reason of Seller's security interest in Products), license fees, customs fees, duties and other charges related thereto, and Customer shall report and pay any and all such shipping charges, premiums, taxes, fees, duties and other charges related thereto, and shall hold Seller harmless therefrom; provided that, if Seller, in its sole discretion, chooses to make any such payment, Customer shall reimburse Seller in full upon demand.
- (d) Stenographical, typographical and clerical errors are subject to correction.
- (e) Prices quoted are for Products only and do not include technical data, proprietary rights of any kind, patent rights, qualification, environmental or other than Seller's standard tests, and other than Seller's normal domestic commercial packaging, unless expressly agreed to in writing by Seller.
- (f) Published weights and dimensions are approximate only. Certified dimension drawings can be obtained upon request. Manuals, programs, listings, drawings or other documentation required hereunder must be referenced specifically.

4. TERMS OF PAYMENT

Unless credit is granted, payment is due upon delivery. All payments for Products released and shipped on approved credit accounts shall be due in full thirty (30) days from date of invoice therefor. Past due balances shall be subject to a service charge not more than the amounts allowed by law. Partial shipments will be billed as made and payments therefor are subject to the above terms. Payment shall not be withheld for delay in delivery of required documentation unless a separate price is stated therefor, and then only to the extent of the price stated for such undelivered documentation. Seller may cancel or delay delivery of Products in the event Customer fails to make prompt payment therefor, or in the event of an arrearage in Customer's account with Seller.

5. SECURITY AGREEMENT (Conditional Sales)

It is agreed by Customer and Seller that as to the Products, Equipment and/or Inventory (referred to herein as "Products") which are the subject of this contract of sale and all acccessions thereto, and proceeds thereof, a purchase money security interest shall attach with Seller as secured party, and with respect to Products which are resold in any form by Customer, Seller shall be the assignee of any security interest which Customer retains or obtains in such Products, until Customer has made payment in full therefor in accordance with the terms hereof. Customer shall be in default if it fails to make any payment as provided for herein or if bankruptcy, receivership, or insolvency proceedings are instituted by or against Customer or if Customer makes any assignment for the benefit of creditors. Upon Customer's default, Seller shall have all the rights and remedies of a secured creditor, as well as those of a seller of goods, under the Uniform Commercial Code, and other applicable law, including but not limited to the RIGHT TO TAKE POSSESSION of the Products herein furnished. Seller may remedy any default and may waive any default without waiving the default remedied or without waiving any prior or subsequent default. Customer agrees to cooperate fully and assist Seller in perfecting and/or continuing Seller's security interest and to execute such documents and accomplish such

filings and/or recordings thereof as Seller may deem necessary for the protection of Seller's interest in the Products herein furnished. The making of this contract of sale by Customer and Seller shall constitute their signing of this Security Agreement.

6. TRANSPORTATION AND RISK OF LOSS

Transportation will normally follow Customer's shipping instructions, but Seller reserves the right to ship Products freight collect and to select the means of transportation and routing when Customer's instructions are deemed unsuitable. Unless otherwise advised, Seller may insure to full value of the Products or declare full value thereof to the transportation company at the time of delivery and all freight and insurance costs shall be for Customer's account. Risk of loss and/or damage shall pass to Customer upon delivery of the Products to the transportation company at the FOB point, whether or not installation is provided by or under supervision of Seller. Title shall pass from Seller to Customer when products are delivered to the transportation company at the location of Seller's manufacturing plant from which the Products are shipped. Confiscation or destruction of, or damage to Products shall not release, reduce or in any way affect the liability of Customer therefor. Notwithstanding any defect or nonconformity, or any other matter, such risk of loss and/or damage shall remain in Customer until the Products are returned at Customer's expense to such place as Seller may designate in writing. Customer, at its expense, shall fully insure Products against all loss and/or damage until Seller has been paid in full therefor, or the Products have been returned, for whatever reason, to Seller. All Products must be inspected upon receipt and claims should be filed with the transportation company when there is evidence of shipping damage, either concealed or external. As used in the clauses appearing herein or attached hereto, "delivery" shall occur when the Product is delivered at the FOB point, which shall be the point of manufacture or such other place as Seller shall specify in writing, notwithstanding installation by or under supervision of Seller.

7. PERFORMANCE

Seller will make all reasonable effort to observe its dates indicated for delivery or other performance. However, Seller shall not be liable in any way because of any delay in performance hereunder due to acceptance of prior orders, technical difficulties, strike, lockout, riot, war, fire, act of God, accident, failure or breakdown of components necessary to order completion, subcontractor, supplier or Customer caused delays, inability to obtain or substantial rises in the price of labor, materials or manufacturing facilities, curtailment of or failure to obtain sufficient electrical or other energy supplies, or compliance with any law, regulation or order, whether valid or invalid, of any cognizant governmental body or any instrumentality thereof whether now existing or hereafter created, or due to any unforeseen circumstances or causes beyond its control. Provided such delay is neither material nor indefinite, Seller's performance shall be deemed suspended during and extended for such time as it is so delayed, and thereafter Customer shall accept performance hereunder. Delay in performance shall not be considered material or indefinite unless it exceeds or is reasonably estimated by Seller to exceed a period of six (6) months. In addition, Seller's inventories and current production must be allocated so as to comply with applicable Government regulations. In the absence of such regulations, Seller reserves the right, in its sole discretion, to allocate inventories and current production and substitute suitable materials when, in its opinion, such allocation or substitution is necessary due to such circumstances or causes in the interest of conservation of scarce materials, and of efficient utilization of high value parts and components. Varian products may contain remanufactured parts and components. Such parts and components are covered by the same warranty and are subject to the same high standards of quality control applied to other parts and components. No penalty clause of any kind shall be effective. As used herein, "performance" shall include, without limitation, fabrication, shipment, delivery, assembly, installation, testing and warranty repair or replacement, as applicable.

8. ACCEPTANCE

The furnishing by Seller of a Product to the Customer shall constitute acceptance of that Product by Customer, unless notice of defect or nonconformity is received by Seller within thirty (30) days of receipt of the Product at Customer's designated receiving address, provided that, for Products for which Seller agrees in writing to perform acceptance testing after installation, the completion of Seller's applicable acceptance tests, or execution of Seller's acceptance form by Customer, shall constitute acceptance of the Product by Customer. Notwithstanding the foregoing, any use of a Product by Customer, its agents, employees, contractors or licensees, for any purpose, after receipt thereof, shall constitute acceptance of that Product by Customer. Seller may repair or, at its option, replace defective or nonconforming parts after receipt of notice of defect or nonconformity.

9. ASSIGNMENTS AND TERMINATIONS

Any assignment by Customer of any contract hereunder without the express written consent of Seller is void. No order may be terminated by Customer except by mutual agreement in writing. Terminations by mutual agreement are subject to the following conditions: (1) Customer will pay all applicable contract prices, for all Products which are completely manufactured and allocable to Customer at the time of Seller's receipt of notice of termination; (2) Customer will pay all costs, direct and indirect, which have been incurred by Seller with regard to Products which have not been completely manufactured at the time of Seller's receipt of notice of termination, plus a pro rata portion of normal profit on the contract; (3) Customer will pay a termination charge on all other Products affected by the termination. Seller's normal accounting practices shall be used to

TERMS AND CONDITIONS OF SALE (continued)

determine costs and other charges. To reduce termination charges, Seller will divert completed parts, material or work-in-process from terminated contracts to other Customers whenever, in Seller's sole discretion, it is practicable to do so.

10. SUPPLIES OR SERVICES FOR THE UNITED STATES GOVERNMENT

To the extent that services or Products furnished hereunder are furnished for delivery pursuant to, or for use in the performance of any contract with the United States or any related subcontract, and to the extent that any contractual provisions are expressly required by the laws or procurement regulations of the United States to be included in such contracts or subcontracts, such contractual provisions are expressly incorporated herein by this reference, with necessary changes in points of detail, e.g., references to parties.

11. PATENTS AND OTHER INTELLECTUAL PROPERTY RIGHTS

Seller will at its own expense and as set forth herein, defend any action brought against Customer in respect to any claim that the design or manufacture of any Product in the Seller's commercial line of Products or manufactured to specifications set by the Seller and furnished hereunder, constitutes an infringement of any patents or other intellectual property rights of the United States or Canada. Subject to the provisions in the DAMAGES AND LIABILITY section hereof, Seller will pay all damages and costs either awarded in a suit or paid, in Seller's sole discretion, by way of settlement, which are based on such claim of infringement, provided that Customer promptly notifies Seller in writing of such claim of infringement and gives Seller full authority, information and assistance in settling or defending such claim, or Seller will, in its sole discretion and at its own expense, either procure a license which will protect Customer against such claim without cost to Customer, replace said Product with a non-infringing product, or remove said Product and refund an equitable portion of the price paid by the Customer to Seller for said Product. Seller shall have no liability whatsoever hereunder with respect to any claims settled by Customer without Seller's prior written consent. Seller EXPRESSLY EXCLUDES from any liability hereunder and Customer shall hold Seller harmless from and against any expense, loss, costs, damages or liability resulting from claimed infringement of patents, trademarks, copyrights or other intellectual property rights: (1) arising from a use of or a combination of said Product with other equipment, processes, programming applications or materials not furnished under this contract, (2) based on items made with the Product furnished under this contract, (3) arising out of compliance by Seller with Customer's designs, specifications or instructions, and/or (4) arising from use or manufacture by anyone of inventions in connection with products or services sold, used or intended for sale or use in performing contracts with the United States or related subcontracts. The foregoing states Seller's entire liability for any claim based upon or related to any alleged infringement of any patent or other intellectual property rights.

12. WARRANTY

(a) Seller customarily warrants that each standard Product sold by it is free of defects in materials and workmanship. Seller warrants that each Article of Seller manufacture will, at the date of its delivery, be free from defects in material and workmanship. THIS WARRANTY IS LIMITED AS FOLLOWS: If any transmitter manufactured by Seller is found to be defective within two (2) years from the date of shipment (one (1) year for rotating machinery such as blowers, motors, and fans), or if any other Article of Seller manufacture is found to be defective within one (1) year from the date of shipment Seller shall fulfill this warranty through repair or replacement of such Article, or at Seller's option, shall take back the Article and refund the purchase price, provided:

1. Written notice of the claimed defect is given to Seller within the applicable warranty period and
2. The Article or constituent claimed to be defective is forthwith returned, transportation prepaid, to Seller at its offices in Dallas County, Texas.

This warranty shall not apply or extend to tubes, lamps, fuses, and other expendable items that are normally replaced as a part of routine maintenance upon their failure. Any Article that is not of Seller manufacture is subject only to the warranty or guarantee of the manufacturer thereof and the Buyer shall receive only such adjustments as Buyer or Seller may obtain from the manufacturer thereof.

(b) This warranty shall not be construed as a warranty or guarantee of any definite coverage or range of any radio transmitter included in the Articles. Buyer acknowledges that he has read and understands the published specifications and equipment manuals pertaining to the Articles and, relying solely on his own judgement or the judgement of a consultant hired by him, has satisfied himself that the Articles are fit for his intended purpose.

(c) The warranty provided hereinabove shall be void in the event (i) the Article fails or malfunctions as a result of improper modifications or repairs thereto by persons other than Seller or improper or insufficient maintenance, or (ii) the Article is subjected to accident, abuse, improper use, or is exposed to conditions more severe than or not in conformity with those specified by Seller in published specifications and applicable equipment manuals, or (iii) the Article is operated on a power source which fails to conform to the voltage requirements specified by Seller in the operational manual delivered with the Article.

(d) THE FOREGOING WARRANTY IS EXPRESSLY IN LIEU OF ANY OTHER EXPRESSED OR IMPLIED WARRANTIES, INCLUDING ANY IMPLIED WARRANTY OF MERCHANTABILITY OR FITNESS FOR PARTICULAR PURPOSE, AND ANY OTHER OBLIGATION ON THE PART OF SELLER IN THIS REGARD.

(e) THE FOREGOING SHALL CONSTITUTE THE BUYER'S SOLE RIGHT AND REMEDY WITH RESPECT TO THE ARTICLES.

13. WARRANTY REPLACEMENT AND ADJUSTMENT

All claims under warranty must be made promptly after occurrence of circumstances giving rise thereto and must be received within the applicable warranty period by Seller or its authorized representative. Such claims should include the Product type and serial numbers, and a full description of the circumstances giving rise to the claim. Before any Products are returned for repair and/or adjustment, written authorization from Seller or its authorized representative for the return and instructions as to how and where these Products should be shipped must be obtained. Any product returned to Seller for examination shall be sent prepaid via the means of transportation indicated as acceptable by Seller. Seller reserves the right to reject any warranty claim not promptly reported and any warranty claim on any item that has been altered or has been shipped by non-acceptable means of transportation. When any Product is returned for examination and inspection, or for any other reason, Customer shall be responsible for all damage resulting from improper packing or handling, and for loss in transit, notwithstanding any defect or non-conformity in the Product. In all cases Seller has sole responsibility for determining the cause and nature of failure, and Seller's determination with regard thereto shall be final.

If it is found that Seller's Product has been returned without cause and is still serviceable, Customer will be notified and the product returned at its expense; in addition, a charge for testing and examination may, in Seller's sole discretion, be made on Products so returned.

14. DAMAGES AND LIABILITY

SELLER'S AGGREGATE LIABILITY IN DAMAGES OR OTHERWISE SHALL NOT EXCEED THE PAYMENT, IF ANY, RECEIVED BY SELLER FOR THE UNIT OF PRODUCT OR SERVICE FURNISHED OR TO BE FURNISHED, AS THE CASE MAY BE, WHICH IS THE SUBJECT OF CLAIM OR DISPUTE. IN NO EVENT SHALL SELLER BE LIABLE FOR INCIDENTAL, CONSEQUENTIAL, OR SPECIAL DAMAGES, HOWSOEVER CAUSED. Liability to third parties for bodily injury, including death, resulting from Seller's performance shall be determined in accordance with applicable law and shall not be affected by the liability limitations stated above in this paragraph.

15. DISPUTES

All disputes under any contract concerning Products not otherwise resolved between Seller and Customer shall be resolved in a court of competent jurisdiction for the location of Seller's manufacturing plant from which the Products are shipped, and in no other place. Provided that, in Seller's sole discretion such action may be heard in some other place designated by Seller (if necessary to acquire jurisdiction over third persons), so that the dispute can be resolved in one action. Customer hereby consents to the jurisdiction of such court or courts and agrees to appear in any such action upon written notice thereof. No action, regardless of form, arising out of, or in any way connected with, the Products or services furnished by Seller, may be brought by Customer more than one (1) year after the cause of action has accrued. If any part, provision or clause of the terms and conditions of sale, or the application thereof to any person or circumstances, is held invalid, void or unenforceable, such holding shall not affect and shall leave valid all other parts, provisions, clauses or applications of the terms and conditions remaining, and to this end the terms and conditions shall be treated as severable.

16. CONTINGENT ORDERS

There are three types of Contingent Orders: 1) Orders contingent upon granting and receipt of an F.C.C. construction permit; 2) Orders contingent upon obtaining financing commitments and 3) Orders contingent on the happening of some other specific event. A contingent order will be honored for a period of six (6) months from the date of the contingent order and will be counted from date of receipt by Seller of the order and the 5% down payment. In the event that (1) FCC permission is not granted or (2) Financing is not obtained or (3) The station construction is not consummated; and upon receipt of the proper written notice by the seller confirming either (1) or (2) or (3), the down payment will be returned in full to the buyer.

GENERAL TERMS AND CONDITIONS APPLYING TO SALE FOR EXPORT

Unless otherwise specified by Continental Electronics, a Division of Varian Associates, Inc. (CED) elsewhere in this quotation, all of the following general terms and conditions apply to this quotation proposal and to any order(s) placed pursuant hereto:

1. PRICES

(a) Prices are in United States Dollars, payable in Dallas, Texas and include delivery of equipment as specified in Section 2(a) hereof and packing for either air freight or underdeck ocean freight export in accordance with CED's standard commercial practices. Prices are based on the quantities specified and are subject to written confirmation in the event quantities different from those specified are ordered.

(b) Equipment prices do not include tests performed in the presence of the purchaser's representative or tests different from those normally made by CED.

(c) Equipment prices include all taxes in effect in the country of origin on the date of this quotation proposal; they do not include taxes which are inapplicable to equipment exported therefrom. Therefore, proof of export, in such form as may be required by the tax authorities concerned, shall be furnished to CED promptly at CED's request. If, as a result of the purchaser's failure to furnish such proof of export, CED becomes liable for the payment of any tax not applicable to equipment exported from the country of origin, the purchaser shall pay to CED the amount thereof upon the submission of CED's invoices therefor. Any tax which may be imposed in the country of origin subsequent to the date of this quotation/proposal shall be added to the price payable by the purchaser. Any tax in effect in, or which may be imposed by, a jurisdiction outside of the country of origin shall be the sole responsibility of the purchaser.

2. DELIVERY

(a) The equipment shall be delivered EX-WORKS, at the factory or warehouse of CED and/or its supplier(s) in the United States or in such country of origin as may be specified in this quotation/proposal, on or before the confirmed delivery period(s). In its discretion CED may make partial deliveries from time to time.

(b) The term EX-WORKS, and the term(s) "FOB", "FAS", "CIF" and/or "C & F", if used in this quotation/proposal shall be defined in accordance with INCOTERMS 1980, a copy of which will be furnished on request.

(c) Delivery shall be complete, and title to each item of the equipment and the risk of loss thereof shall pass to the purchaser, upon delivery to the carrier at the factory or warehouse of CED and/or its supplier. The purchaser shall have no right to inspect the equipment prior to delivery, unless the purchaser specifically requests such right in writing and CED agrees in writing to grant such right.

(d) The delivery date(s) and/or period(s) specified are only estimates and are computed from the date on which all of the following are in CED's possession: (1) an order acceptable to CED, (2) evidence of completion of payment arrangements satisfactory to CED, e.g. notice from U.S. Bank acceptable to CED of confirmation of the purchaser's irrevocable Letter of Credit in conformity with Section 6 hereof, (3) down payment if specified, and (4) all information and documents necessary to permit CED to proceed immediately and without interruption.

(e) Delivery estimates are subject to confirmation at the time of CED's acceptance of the order. Notwithstanding such confirmation, CED shall not be liable on account of any delay in the delivery of, nor shall CED be liable for inability to deliver, any item(s) of equipment if such delay or inability results directly or indirectly from "Force Majeure" as defined in Section 3 hereof. In no event shall CED be liable for consequential damages for delay in the delivery of, or failure to deliver, any item(s) of equipment.

(f) In the event that at such time as CED is prepared to deliver item(s) of equipment, such delivery is prevented for a period of thirty days or more, either by reason of the purchaser's failure to arrange, or to request CED to arrange, for shipment, or by reason of any cause referred to in Section 3 hereof, CED may deliver such item(s) by placing the same in storage in CED's warehouse or in a public warehouse. In such event, delivery shall be complete, and title to such item(s) and the risk of loss thereof shall pass to the purchaser, when the same are placed in storage; all storage charges (including reasonable storage charges imposed by CED, if storage is in CED's warehouse) and all expenses, if any, incurred by CED in connection therewith shall be for the account of the purchaser. In such event, if the purchaser requests CED in writing to dispose of such item(s) of equipment, CED shall endeavor to do so in the most advantageous manner for the purchaser's account.

3. FORCE MAJEURE

"Force Majeure", as used in this quotation/proposal, means any law, order, regulation, direction or request of the United States Government, of any other government having jurisdiction over CED, its subcontractors and/or its suppliers, or of any department, agency or corporation of any one or more of such governments; failure or delay of transportation; insurrection; riots; sabotage; national emergency; war; acts of public enemies, strikes or other labor difficulties; inability to obtain necessary labor, manufacturing facilities, material or components from CED's usual sources; fires, floods, or other catastrophes, acts of God; acts or omissions of the purchaser; or any causes of like or different kind beyond the control of CED. CED shall not be liable for failure to perform any of its obligations, if such failure to perform any of its obligations, if such failure results directly or indirectly from "Force Majeure".

4. WARRANTY

(a) CED warrants each item of equipment of its manufacture furnished hereunder to be free from defect in material and workmanship under normal use and service when properly installed, maintained and used for the purposes for which it is designed for a period of one year after the date of delivery in accordance with Section 2 hereof, provided that notice of any such alleged defect is given to CED within sixty days after the discovery thereof and provided that inspection by CED confirms the existence thereof to CED's reasonable satisfaction. CED's liability under this warranty is limited to the replacement of defective parts to the purchaser EX-WORKS at CED's factory or warehouse. At CED's request, any part alleged to be defective shall be returned to CED for inspection, properly packed and all expenses prepaid, but no part shall be returned to CED by the purchaser prior to authorization by CED. The foregoing warranty does not apply to semiconductors, electron tubes, batteries or other expendable parts normally consumed in operation, all of which shall be subject to the manufacturer's standard warranty and adjustment policies covering such products and parts. CED shall in no event be liable for loss of use or for incidental, indirect, or consequential damages whether in contract or in tort.

(b) Equipment furnished by CED, but not of its manufacture, bears only the warranty given by the manufacturer thereof. Used equipment is sold "as is" and bears no warranty.

(c) The purchaser agrees that CED has the right to defend, or, at its option, to settle, and CED agrees, at its own expense, to defend or, at its option, to settle any claim, suit or proceeding brought against the purchaser on the issue of infringement of any United States patent by any product, or any part thereof, supplied by CED to the purchaser hereunder, CED agrees to pay, subject to the limitations hereinafter set forth in this subsection, any final judgment entered against the purchaser on such issue in any such suit or proceeding defended by CED. The purchaser agrees that CED at its sole option shall be relieved of the foregoing obligations unless the purchaser notifies CED promptly in writing of any such claim, suit or proceeding and gives CED proper and full information and assistance to settle and/or to defend any such claim, suit or proceeding. If the product, or any part thereof, furnished by CED to the purchaser becomes, or in the opinion of CED may become, the subject of any claim, suit or proceeding for infringement of any United States patent, or in the event of an adjudication that such product or part infringes any United States patent, or if the use, lease or sale of such product or part is enjoined, CED may, at its option and its expense (1) procure for the purchaser the right under such patent to replace such product or part, or (2) modify such product or part, or (3) remove such product or part and refund the aggregate payments and transportation costs paid therefor by the purchaser, less a reasonable sum for use, damage and obsolescence, CED shall have no liability for any infringement arising from: (i) the combination of such product or part with any other product or part whether or not furnished to the purchaser by CED, or (ii) the modification of such product or part unless such modification was made by CED, or (iii) the use of such product or part in practicing any process, or (iv) the furnishing to the purchaser of any information, data, service or application assistance. The purchaser shall hold CED harmless against any expense, judgment or loss for infringement of any United States patents or trademarks which results from CED's compliance with the purchaser's designs, specifications or instructions. CED shall not be liable for any costs or expenses incurred without CED's written authorization, and in no event shall CED's total liability to the purchaser under, or as a result of compliance with, the provisions of this subsection (c) exceed the aggregate sum paid to CED by the purchaser for the allegedly infringing product or part, exclusive of any refund under option (3) above, CED shall in no event be liable for loss of use or incidental, indirect, or consequential

damages, whether in contract or in tort. The foregoing states the entire warranty by CED and the exclusive remedy of the purchaser, with respect to any alleged patent infringement by such product or part.

(d) CED warrants the radio transmitters of its manufacture shall deliver their full rated power output at the output terminals, but such warranty shall not be construed as a warranty of any definite coverage or range of the equipment.

(e) No warranties, whether statutory, expressed or implied, including, but not limited to, those of merchantability, fitness for any particular purpose, and of freedom from infringement or the like, other than those set forth in this Section 4, shall apply to the equipment furnished hereunder.

5. IMPORTATION AND INSTALLATION

The purchaser assumes all responsibility for the importation, installation and operation of the equipment, including the obtaining of all permits, licenses or certificates required therefore. CED shall in no event be liable for the failure of any government to issue such permits, licenses or certificates.

6. PAYMENT TERMS

Payment for the equipment specified in this quotation/proposal shall be made in U.S. Dollars, through the medium of an irrevocable Letter of Credit in favor of Continental Electronics, a Division of Varian Associates, Inc. confirmed by a U.S. bank acceptable to CED. Said Letter of Credit shall be valid for a period of time sufficient to enable CED to receive payment in full plus thirty days, shall be for the total price of the equipment and in a form acceptable to CED and shall authorize partial payments against partial deliveries. In the event that the shipping expenses specified in Section 7 hereof are to be prepaid by CED for the purchaser's account, the Letter of Credit shall include an amount sufficient to cover same. The Letter of Credit shall provide for payments to CED upon presentation to the confirming bank for one hundred percent of the invoice value of each delivery, accompanied by commercial invoice(s) and either by shipping documents or by CED's certificate that the item(s) of equipment covered by said invoice(s) have been and are ready for delivery, but delivery thereof has been prevented by reason of a cause specified or referred to in subsection (f) of Section 2 hereof for a period of thirty days or more. For shipment of merchandise of other than U.S. origin, the Letter of Credit shall permit shipment from as many other countries as may be required and shall permit presentation of non-negotiable copies of bills of lading provided they are accompanied by CED's declaration that the originals have been airmailed directly to the opening bank. All bank charges in connection with said Letter of Credit, including those of the confirming bank, shall be for the account of the purchaser.

7. SHIPMENT

If the purchaser requests CED to arrange for shipment and CED agrees in writing to do so, CED shall act as the purchaser's agent for such purpose. In such case, and if the purchaser so requests, CED shall take out marine insurance, including standard warehouse coverage, and such other insurance as the purchaser may specify in writing, if obtainable by CED, to cover shipment. All freight and insurance charges, out of pocket expenses, fees and costs including the cost of preparing consular invoices, shall be paid by the purchaser upon submission of invoices therefore. Unless instructed by the purchaser, CED will make consular declarations in good faith, according to its best judgment, but without liability for any errors or incorrect declarations.

8. PURCHASES FINANCED BY U.S. GOVERNMENT

If the purchaser of the equipment is to be financed directly or indirectly with funds provided by the United States of America (for example, Export-Import Bank or AID funds) the purchaser should so advise CED promptly.

9. EXPORT LICENSES AND GOVERNMENT REGULATIONS

The purchaser or CED, whichever is the proper party under the applicable statute or regulation, shall make application for any government export license, preference rating or other government authorization which may now or hereafter be required in order to manufacture or export the equipment, and the parties shall cooperate with and assist each other in every manner reasonably possible in securing any such license, rating or authorization. CED shall in no event be liable for any government's failure or refusal to issue, or cancellation or suspension of, any such license, rating or authorization.

10. OTHER CONDITIONS

(a) Modifications of the equipment by CED or its suppliers may be made from time to time prior to delivery for reasons such as improvement in performance or availability of materials, but not to such an extent that the performance of the equipment will be adversely affected.

(b) No sale or lease hereunder shall convey any license by implication, estoppel or otherwise, under any proprietary or patent rights of CED, to practice any process with such product or part, or for the combination of such product or part, with any other product or part.

(c) This quotation/proposal is subject to change at any time upon notice and expires thirty days from its date, unless otherwise indicated herein or extended in writing by CED. This quotation/proposal does not constitute an offer by CED, and any order or orders placed hereon are subject to written acceptance by CED in the United States at its Dallas, Texas offices. The banking, negotiation, endorsement or other use of the purchaser's down payment, if any, shall not constitute acceptance by CED. In the event CED does not receive, within thirty days after receipt of the purchaser's order, evidence of completion of payment arrangements satisfactory to CED, CED shall have the right, at its option, to cancel, without prior notice, the contract(s) resulting from its acceptance of the order.

(d) CED is willing to consider terms and conditions different from, or additional to, those set forth herein. However, unless CED expressly agrees thereto in writing prior to, or at the time of, acceptance of the purchaser's order, unless otherwise expressly stated by CED in writing, CED's acceptance of such purchase order is hereby expressly made conditional on assent by the purchaser to all of the terms and conditions stated herein and/or elsewhere in this quotation/proposal and to the waiver by the purchaser of any different or additional terms or conditions.

(e) This quotation/proposal, any order(s) placed pursuant hereto, and any contract(s) resulting from acceptance of such order(s) shall be construed and interpreted in accordance with, and governed by, the laws of the State of Texas, United States of America.

(f) This writing is intended by the parties as a final expression of their agreement and is intended also as a complete and exclusive statement of the terms and conditions of their agreement. No course of prior dealings between the parties and no usage of the trade shall be relevant to supplement or explain any terms used in any contract(s) resulting from acceptance of any order(s) placed pursuant hereto. Acceptance or acquiescence in a course of performance rendered under any such contract shall not be relevant to determine the meaning of such contract even though the accepting or acquiescing party had knowledge of the nature of the performance and opportunity for objection.

(g) Any contract(s) resulting from acceptance of any order(s) placed pursuant hereto can be modified or rescinded only in writing signed by both of the parties or by their duly authorized representatives.

(h) This quotation/proposal is submitted with the understanding that the ultimate destination of the equipment is the country indicated herein, and all invoices issued by CED in connection with the sale thereof shall so indicate. The purchaser is hereby notified that diversion of the equipment to any other destination contrary to United States law is prohibited. Accordingly, if the foregoing understanding is incorrect, or if the purchaser intends to divert the equipment to any other destination, then purchaser shall immediately inform CED of the correct ultimate destination.

(i) The prices stated in this quotation/proposal are submitted on the understanding that any order or contract resulting therefrom shall, at CED's election, be subject to adjustment upward or downward to reflect changed costs to CED.

(j) Limitation of Liability. CED shall not be liable for any consequential damages of Buyer. This limitation of liability of CED shall include, but is not confined to, consequential damages arising from or caused by, directly or indirectly, a delay in delivery of the Articles, breach of warranty, use of the Articles by Buyer, breach of any obligation by CED, negligence, strict liability and any other act or omission of CED. Liability to third parties for bodily injury, including death, resulting from Seller's performance shall be determined in accordance with applicable law and shall not be affected by the liability limitation stated above in this paragraph.

QUOTATION/PROPOSAL NO.

DATE

REV.E K32-27(5)

**Continental's Customer Service . . .
*The Industry's Best!***

Call Anytime, Day Or Night.

**Main Offices:
(214) 381-7161**

**Parts:
(214) 388-3737**

**Engineering Service:
(214) 388-5800**

Telex: 73-398

FAX: (214) 381-4949

varian 

continental electronics division

4212 South Buckner Blvd., PO Box 270879
Dallas, Texas 75227 Ph: (214) 381-7161



varian 

continental electronics division

■ Dallas, Texas 75227 ■ Telephone: 214-381-7161 ■ Fax: 214-381-4949

