

GATES
TRANSMITTING EQUIPMENT
ALL OVER THE WORLD

FREQUENCY MODULATED BROADCAST TRANSMITTER

Model BF-250A

250 Watts

Approved by the FCC

Scanned and Prepared
by Dale H. Cook

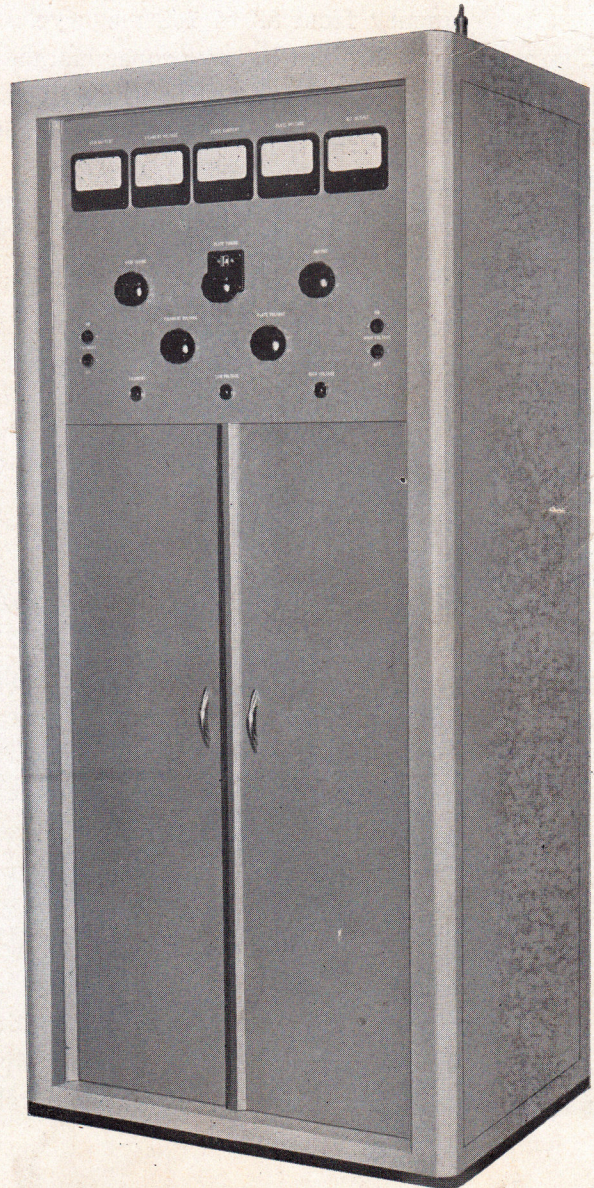

GATES RADIO COMPANY
MANUFACTURERS, ENGINEERS, SINCE 1922
QUINCY, ILLINOIS, U.S.A.

GATES
TRANSMITTING EQUIPMENT
ALL OVER THE WORLD

THIS transmitter will provide 250 watts of frequency modulated power to a properly designed antenna and transmission line system on any frequency from 88 to 108 megacycles. Characteristics obtained in any proper installation will exceed those required by the Federal Communications Commission for FM broadcast service.

Installations requiring in excess of 250 watts can use the BF-250A as the basic exciter unit for one or three kilowatt amplifiers or obtain still more power by adding still higher powered stages.

Modulator and Frequency Multiplier

Modulation is accomplished in the BF-250A by the phase shift method utilizing a GL-2H21 vacuum tube. This system makes possible direct crystal control of the carrier frequency and thereby eliminates a multiplicity of tubes and mechanical controls inherent in many systems. The small amount of audio power required for modulation is provided by a two stage amplifier which also contains the pre-emphasis circuit. The audio input level required is relatively low so that if desired a fixed attenuator may be inserted to obtain accurate matching to auxiliary audio equipment having comparatively low output level.

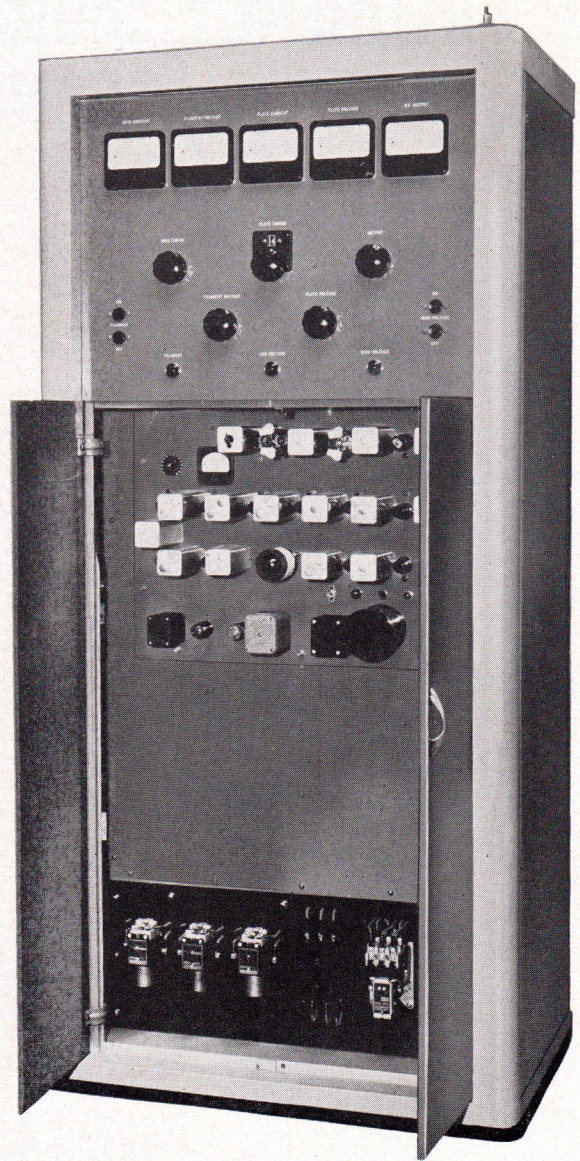

Grouping of the controls on the BF-250A is arranged so that operation is easy. Four inch meters are used to facilitate accurate adjustments. Switches and relays are along the bottom—easily reached when the front doors are opened.

GATES RADIO COMPANY
MANUFACTURERS, ENGINEERS, SINCE 1922
QUINCY, ILLINOIS, U.S.A.

GATES
TRANSMITTING EQUIPMENT
ALL OVER THE WORLD

Two temperature controlled crystals are provided, either selected by a switch, to generate and control the original frequency. This frequency is in the neighborhood of 200 kilocycles and is fed to the GL-2H21, modulated and then further increased to the carrier frequency by a series of multiplier stages. Following this

is a driver amplifier that has ample output to drive the final RF amplifier stage.

Indication of plate current in the low powered stages is available on a milliammeter which operates in conjunction with a selector switch to connect it in any desired amplifier stage.

The neat arrangement in the back of the BF-250A is evidence of the careful design work on this unit. All components are readily accessible and properly placed to best perform their appointed functions. The cover of the modulator-amplifier section (center) is quickly removable and exposes all components. Note the generously proportioned power components at the bottom.

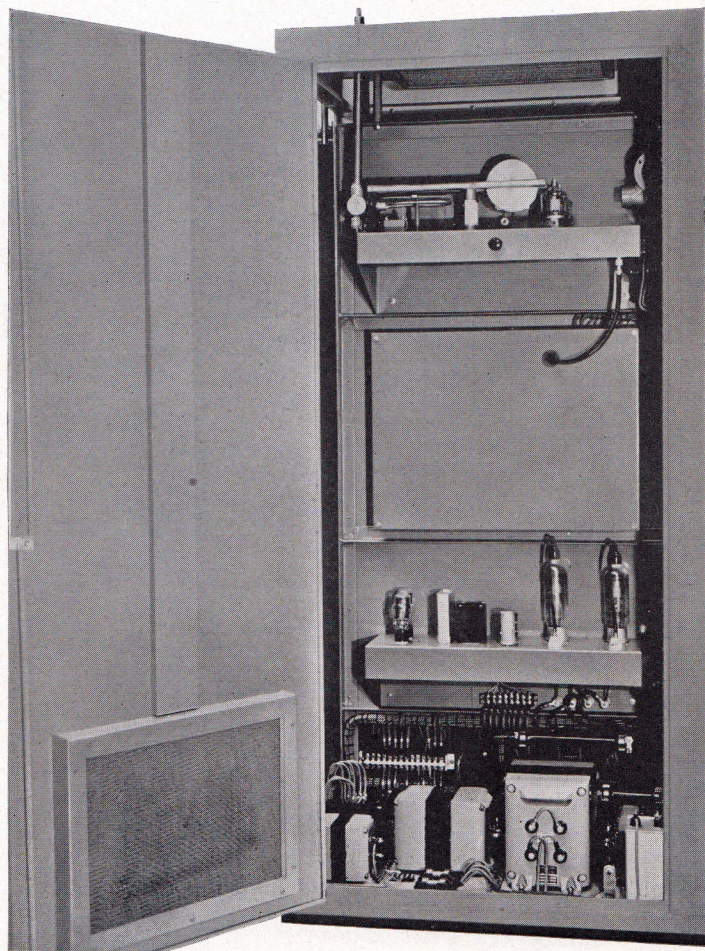

GATES RADIO COMPANY
MANUFACTURERS, ENGINEERS, SINCE 1922
QUINCY, ILLINOIS, U.S.A.

GATES
TRANSMITTING EQUIPMENT
ALL OVER THE WORLD

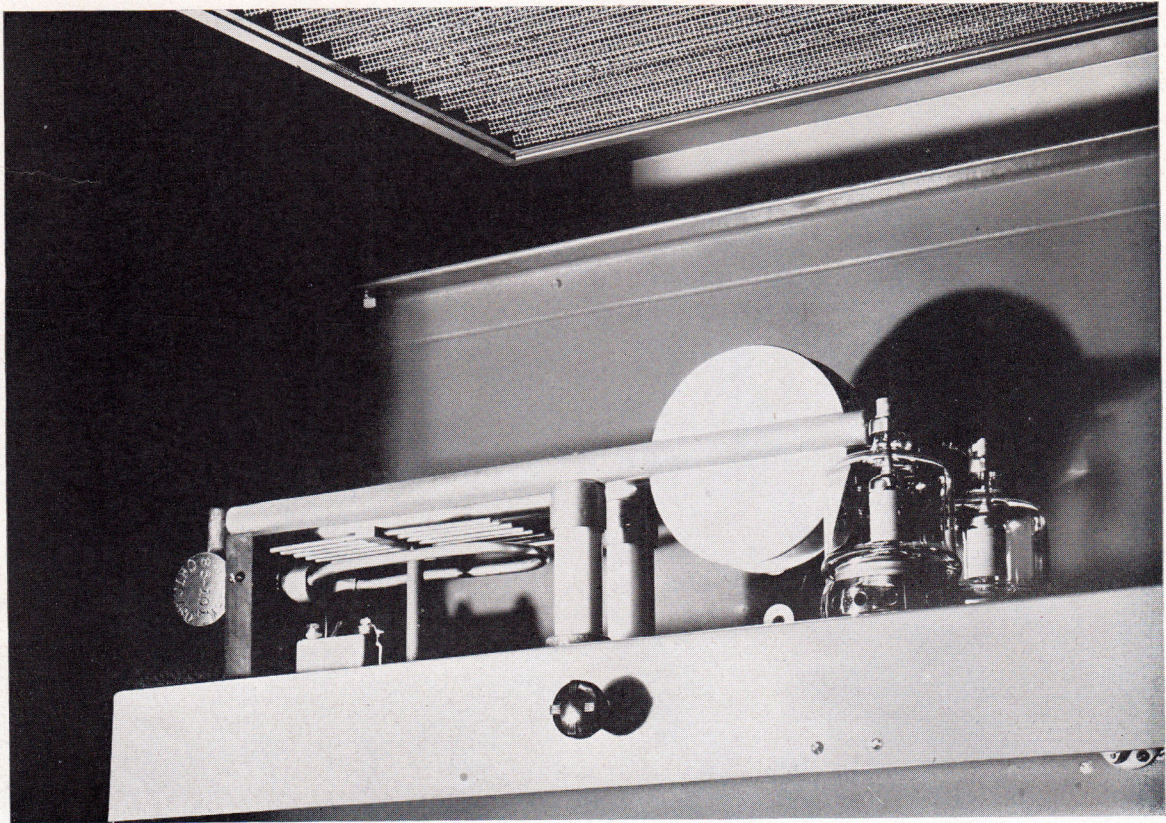

This view of the final amplifier clearly shows the tank circuit construction and placement of the type 4-125A tubes. All metallic parts that perform electrical functions are silver plated. A blower, not shown, provides a blast of air for cooling the tubes, thus materially extending their life.

Tuning of each stage is easily done by observing the indications of a vacuum tube tuning meter when plugged into jacks directly adjacent to the stage under observation. This item is supplied with each transmitter. The design of the multiplier stages allows easy adjustment to maximum performance by use of this simple transmitter accessory.

Power Amplifier

A short length of concentric transmission line is used to carry power from the driver stage to the grid circuit of the two type 4-125A power amplifier tubes. They are connected in push-pull using as a tank circuit a single turn inductance actually composed of two

GATES RADIO COMPANY
MANUFACTURERS, ENGINEERS, SINCE 1922
QUINCY, ILLINOIS, U.S.A.

GATES TRANSMITTING EQUIPMENT ALL OVER THE WORLD

metallic tubes mounted parallel to each other, one end of each being connected to the plates of the tubes and the other ends shorted together by a movable bar. The bar may be placed in a position suitable for obtaining approximate resonance of the tank circuit. Fine adjustments are secured by spacing of the round plates located near the open end of the tank inductance. One of these is positioned by a control knob on the front panel. Power is taken from the final amplifier by means of a small loop located just below the plate inductance. An electrostatic shield is placed between it and the plate inductance to balance

loading on each power amplifier tube and thereby obtain optimum efficiency. The pick-up feeds the power into a $\frac{7}{8}$ inch concentric transmission line which is brought out thru the top of the transmitter where it may be connected to the transmission line to the antenna or to a successive power amplifier.

This view shows the power components and rectifier tubes. All wiring is neatly arranged and designated for quick comparison with diagrams in the instruction book to facilitate maintenance.

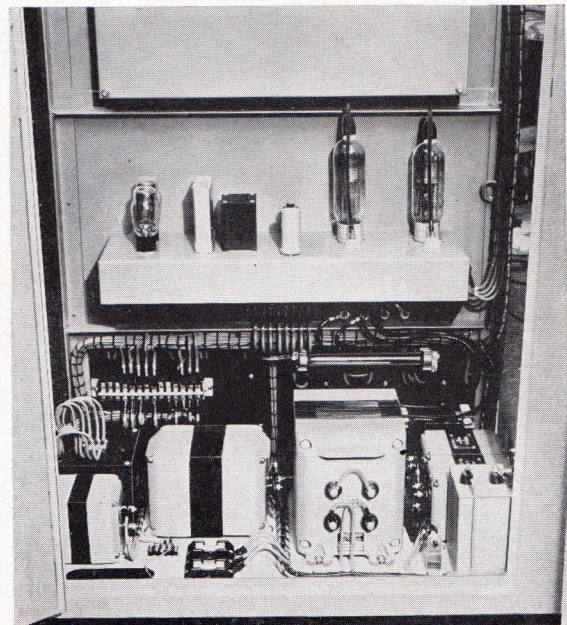

Construction

Standard practices used in the building of the BF-250A transmitter are silver plating of all inductances that carry RF power, copper plating on all chassis and frame members, using over size components in all circuit breakers

is employed to furnish protection to the equipment and interlocks on the rear door prevent operating personnel from accidental contact with dangerous voltages when the door is open.

GATES RADIO COMPANY
MANUFACTURERS, ENGINEERS, SINCE 1922
QUINCY, ILLINOIS, U.S.A.

GATES
TRANSMITTING EQUIPMENT
ALL OVER THE WORLD

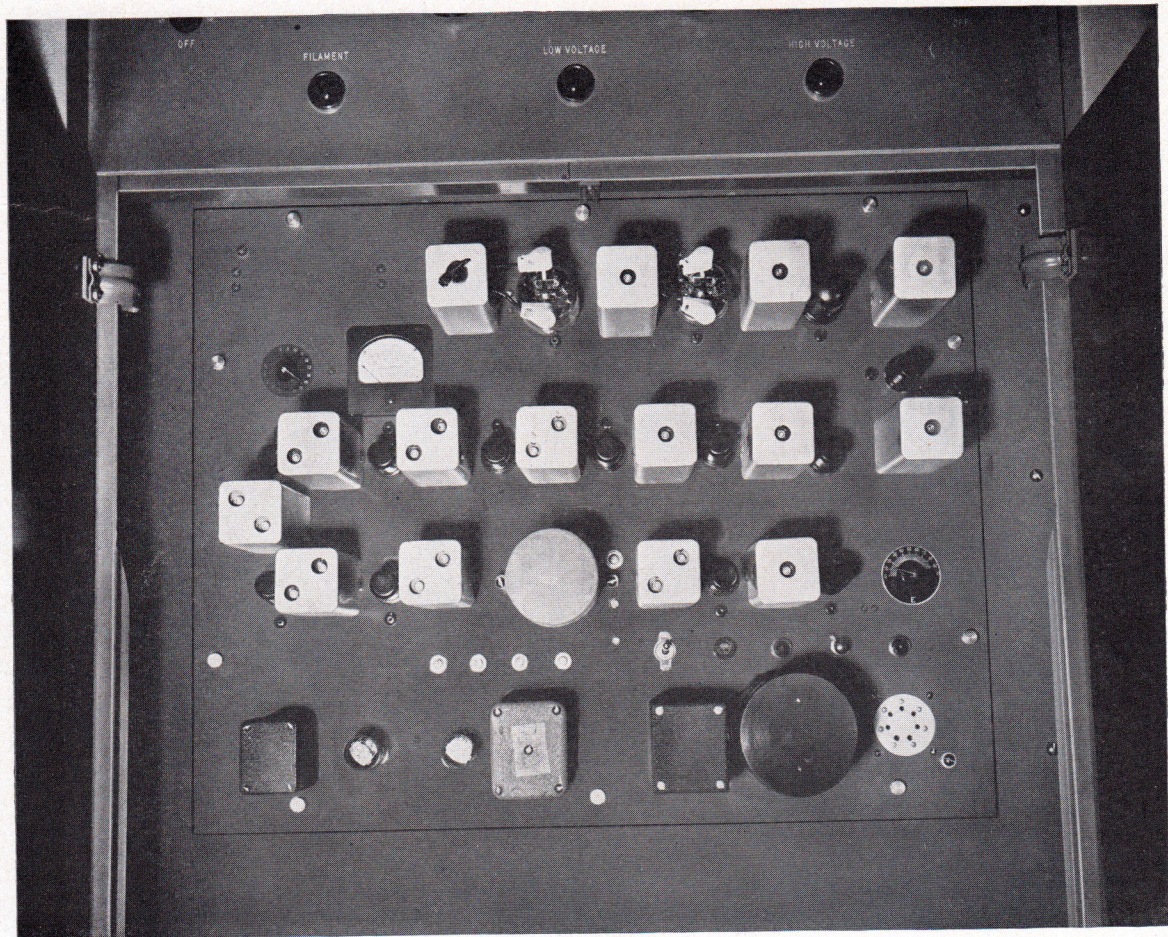

The modulator-amplifier section shown above is the heart of the BF-250A transmitter. In the second row of components inside the round shield is the GL-2H21 tube which performs the modulation. The modulation inductance is built inside the shield and is easily removable for tube replacements. The blank socket in the lower right corner accommodates the second crystal and oven.

Access to all components is possible thru either the back or front doors. However, the sides of the cabinet are also removable to further assist maintenance. The cabinet is dust and insect proof but has ample ventilation thru the filters in the bottom of the rear door and

top of the cabinet. Forced air circulation is used on the power amplifier stage which increases tube life. Blower noise is inaudible a short distance from the transmitter facilitating the use of announcing provisions in the same room if desirable.

GATES RADIO COMPANY
MANUFACTURERS, ENGINEERS, SINCE 1922
QUINCY, ILLINOIS, U.S.A.

GATES TRANSMITTING EQUIPMENT ALL OVER THE WORLD

Controls and Meters

Push button stations are located on the front panel for application of filament and plate voltages with indicators that light when the filament, low voltage and high voltage supplies are operating. Three rheostats controlled from the front panel adjust filament and plate and allow the power output to be varied from approximately 50 to 320 watts. Power am-

plifier grid and plate tuning controls are also located on the front panel. The plate tuning control is associated with a counter that shows the setting within one part in three hundred.

Five four-inch meters are mounted along the top of the front panel and indicate power amplifier grid current, plate current, plate voltage, filament voltage and RF output.

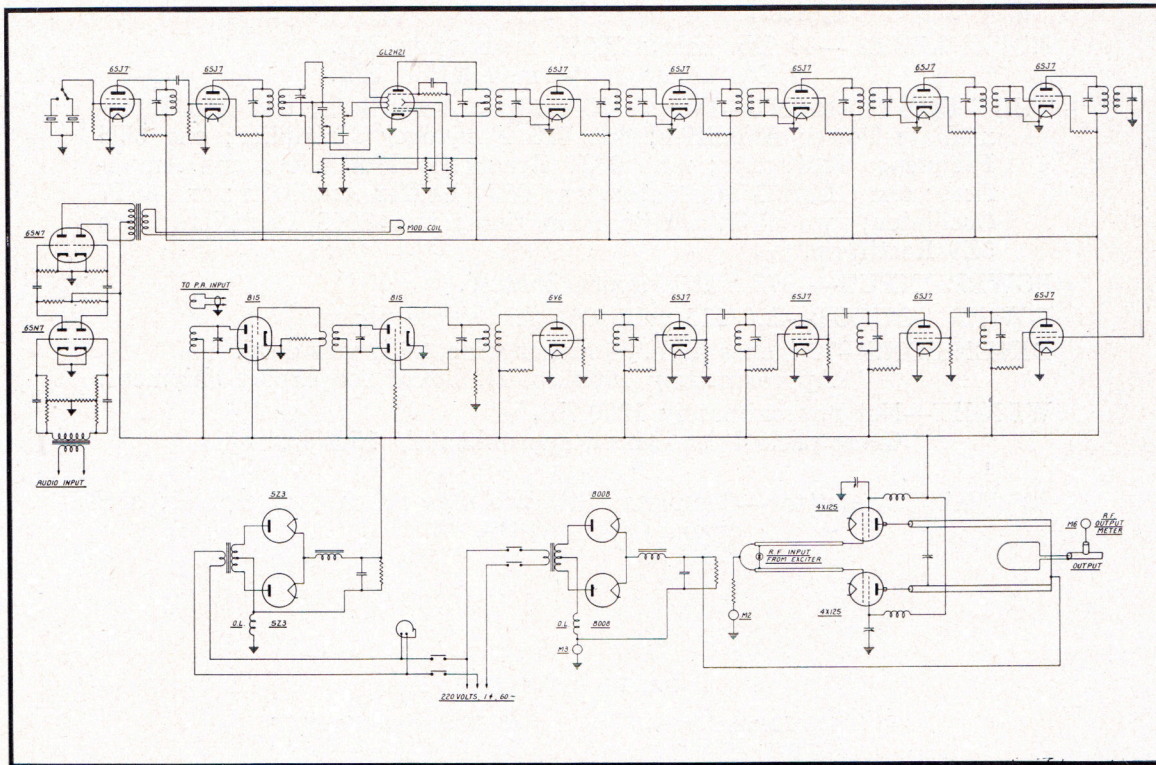

This schematic shows the major circuit functions of the BF-250A transmitter.

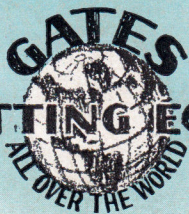

TRANSMITTING EQUIPMENT

SPECIFICATIONS

- POWER OUTPUT—250 watts nominal rating.
FREQUENCY RANGE—88 to 108 megacycles.
RF OUTPUT IMPEDANCE—40-80 ohms.
TYPE OF OSCILLATOR—Direct crystal control.
FREQUENCY STABILITY— ± 250 cycles.
TYPE OF MODULATION—Phase shift.
MODULATION CAPABILITY—100 kilocycles.
AUDIO INPUT IMPEDANCE—600 ohms.
AUDIO INPUT LEVEL—Approximately zero decibels.
FREQUENCY RESPONSE—Within $1\frac{1}{2}$ Db. of standard 75 microsecond pre-emphasis curve.
DISTORTION—Maximum $1\frac{1}{2}\%$ 50-100 cycles, less than 1% above 100 cycles.
NOISE LEVEL—60 Db. below 100% modulation FM.
50 Db. below 100% modulation AM.
TUBE COMPLEMENT—Two 4-125A Final Amplifiers; one 815 Intermediate Power Amplifier; one 815 Frequency Multiplier; one 6V6 Frequency Multiplier; nine 6SJ7 Frequency Multipliers and Amplifiers; one GL2H21 Modulator; one 6SJ7 Buffer Amplifier; one 6SJ7 Oscillator; two 6SN7 Audio Amplifiers; two 8008 Rectifiers; two 5Z3 Rectifiers.
POWER INPUT—1375 watts, approximately.
POWER SOURCE—220/115 volts 60 cycle single phase.
DIMENSIONS—78 inches high, 36 inches wide, 26 inches deep.
Approximately 1000 cu. ft. boxed for export shipment.
WEIGHT—Net approximately 1200 lbs.
Gross packed for export, approximately 1500 lbs.
BF-250A Transmitter—Complete with two sets tubes, two crystals and oven. Code ZADOS.

SALES OFFICES

123 Hampshire
Quincy, Illinois

40 Exchange Place
New York 5, N. Y.

in other sections of the United States
Distributors are conveniently located



GATES RADIO COMPANY
MANUFACTURERS, ENGINEERS, SINCE 1922
QUINCY, ILLINOIS, U.S.A.